

 YEARS
TOGETHER

GENEBRE

Feel the Water



2021

**Colección Grifería
Cocina y Baño**

Tap Collection
Kitchen & Bathroom



GENEBRE

Feel the Water

Contacto Contact

GENEBRE GROUP

Edificio Genebre
Avda. Joan Carles I, 46-48
Distrito económico de l'Hospitalet
08908 l'Hospitalet de Llobregat
Barcelona (SPAIN)
Teléfono / Phone +34 93 298 80 00
www.genebre.es

CONTACTO COMERCIAL COMMERCIAL CONTACT

España / Spain
Teléfono / Phone +34 93 298 80 01
Fax: + 34 93 298 80 06
griferia@genebre.es

Europa / Europe
Teléfono / Phone +34 93 298 80 15

Europa este / East Europe
Teléfono / Phone +34 93 298 80 19

América latina / Latin America
Teléfono / Phone +34 93 298 80 17

América del norte / North America
Teléfono / Phone +34 93 298 80 00
Fax: + 34 93 298 80 08

www.genebre.com
exportacion@genebre.es

OTROS TELÉFONOS OTHER GENERAL TELEPHONE NUMBERS

Centralita / Central telephone number
Teléfono / Phone +34 93 298 80 00

Administración / Administration
Teléfono / Phone +34 93 298 80 02
Fax: + 34 93 298 80 07

**Servicio de atención técnica al cliente /
Technical support**
Teléfono / Phone +34 902 504 203

Cada vez más cerca de ti

En Genebre trabajamos día a día para seguir mejorando todos nuestros canales de comunicación contigo. Especialmente a través de nuestra web. Por eso, ya seas profesional, instalador, colaborador, usuario o cliente, en nuestro site encontrarás toda la información que necesites. Las 24 horas del día. Los 365 días del año.

Una web donde podrás ver nuestros catálogos, productos, recambios, accesorios, consejos de instalación, videos, noticias y descubrir todas nuestras novedades antes que nadie, además de disponer de tu propio espacio de usuario donde consultar pedidos, albaranes, facturas y seguimiento.

Getting closer to you

At Genebre we work every day to continue improving all our communication channels with you. Especially through our website. Whether you are a professional, installer, collaborator, user or client, on our site you will find all the information you need. 24 hours a day. 365 days per year.

A website where you can see our catalogs, products, spare parts, accessories, installation tips, videos, news and discover all our innovations before anyone else, as well as having your own user-space where you can check orders, delivery notes, invoices and tracking.



Porque nuestro deseo es seguir ayudándote más y mejor cada día.

Because our desire is to continue helping you more and better every day.

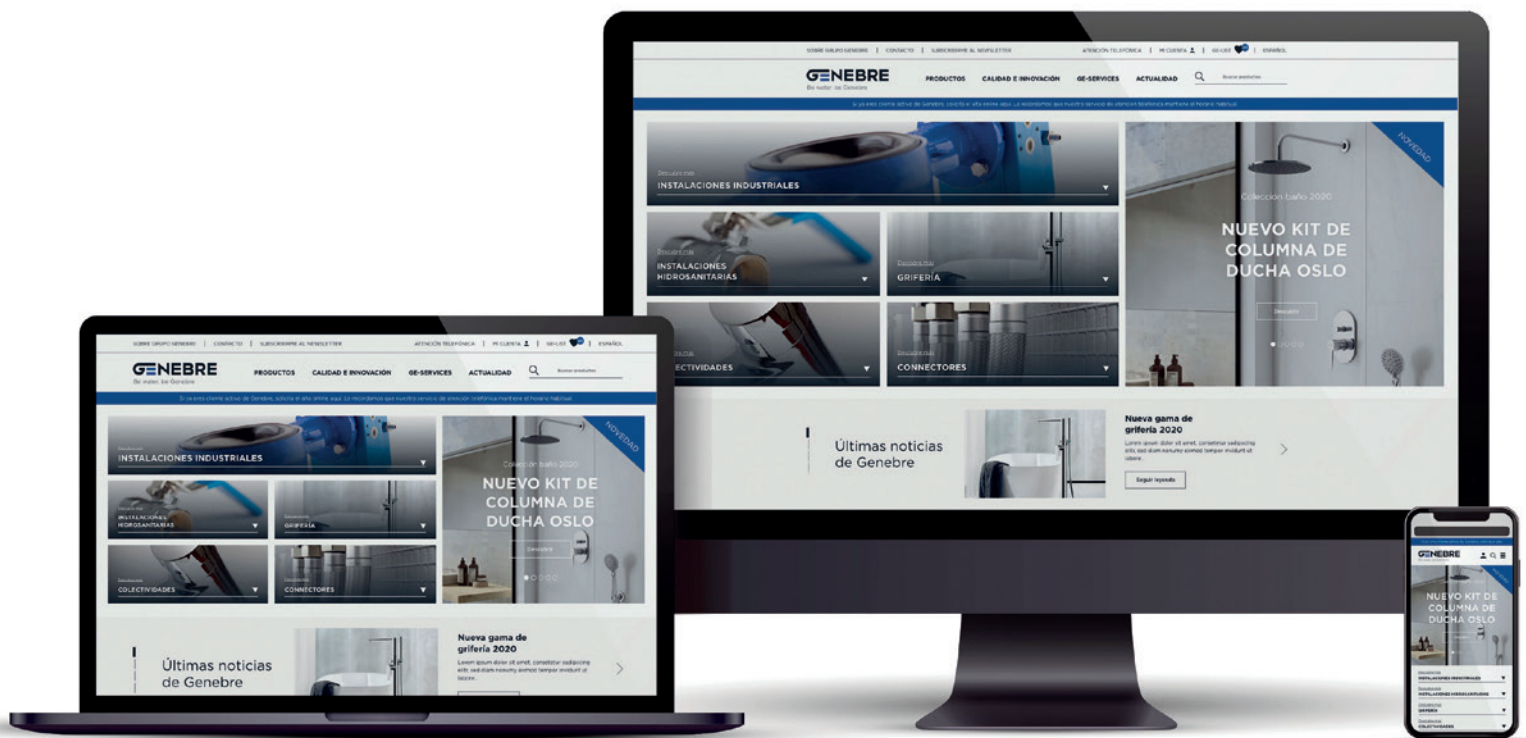

www.genebre.es



Índice

Index



Feel the Water p.06

Feel the Quality p.08

Más opciones ecológicas
More green options p.10

Tecnología
Technology p.12

Novedades 2021
News 2021 p.14

Grifería para Baños

Bathroom taps p.16

Koral	20
Kode	28
Oslo	36
Oslo Black	46
Klip	56
Kelogic	62
Tau	70
Tau 2	80
Kenjo	86
K8	94
Ge2	100
New Regent Classic	108
New Regent	114
Gamma	120
Ixo	126
Kross	130
Kalo	134
Shower style	138



Grifería para Cocinas Kitchen taps p.148

Fregaderas para encimeras Countertop sink mixers	152
Fregaderas para filtrado Sink mixers for filtration	158
Fregaderas extraíbles Pull out sink mixers	160
Fregaderas con muelle Sink mixers with spring	164
Fregaderas murales Wall-mounted sink mixers	166
Fregaderas abatibles Folding sink mixers	168
Fregaderas selección inox Stainless steel selection sink mixers	169
Fregaderas Classic Classic sink mixers	172
Fregaderas de 1 agua One-water sink taps	184

Accesorios Accessories	p.186
----------------------------------	-------

Recambios Spare parts	p.202
---------------------------------	-------

Información técnica Technical information	p.216
---	-------

Índice por referencia Index by reference	p.273
--	-------

Condiciones de venta Sales conditions	p.278
---	-------

Feel the Water

El agua es vida. Sólo con verla y oírla, aumenta el flujo sanguíneo en el cerebro y el corazón, y nos relaja.

En Genebre sabemos la gran variedad de beneficios que sólo el agua puede ofrecer. Por eso seguimos mejorando continuamente nuestros productos para que tu experiencia con el agua sea cada día mejor. Esa es nuestra razón de ser y lo que en realidad mejor sabemos hacer.

Water is life. Just seeing and hearing it increases the blood flow in the brain and heart, and relaxes us.

At Genebre, we know the great variety of benefits that only water can offer. That's why we continue improving our products so that your experience with water is better every day. That is our reason for being and what we really know best how to do.







Feel the quality



En Genebre podríamos hablarte de los rigurosos exámenes que organismos de certificación independientes han realizado a todos nuestros productos (laboratorios ENAC, laboratorio Oliver Rodés).

También podríamos aburrirte enumerando las complejas normativas que cumplen nuestros productos (la ISO 9001, la ISO 14001, la UNE-EN 19703, la EN 1982, la CW617N, la EN 12165, la ISO 9227, la EN 200, la NF 077, la EN1717, ...).

O maravillarte con las numerosas pruebas de resistencia a las que sometemos a nuestros productos antes de que salgan al mercado (discos cerámicos capaces de resistir más de 200.000 maniobras, giro de los caños que después de más de 80.000 accionados siguen como el primer día, cromados resistentes a la corrosión, plásticos anticalcáreos, el latón y sus aleaciones, etc...).

Pero por encima de todo, queremos hablarte de nuestro compromiso con la calidad y la salud, del ahorro de agua y energía o de la garantía y la asistencia técnica con la que nos encontrarás siempre a tu lado.

Homologación CE y otras específicas para mercados como Bielorrusia, Chile, Polonia, Rusia, Ucrania, Singapur y Arabia Saudí.

At Genebre we could tell you about the rigorous examinations that independent certification institutions have carried out on our products (ENAC laboratories, Oliver Rodés laboratory).

We could also bore you just by listing the large list of regulations that our products comply with (ISO 9001, ISO 14001, UNE-EN 19703, EN 1982, CW617N, EN 12165, ISO 9227, EN 200, NF 077, EN1717, ...).

Or marvel you with the numerous resistance tests that we always undergo internally to our products before they are launched on the market (ceramic discs capable of withstanding more than 200,000 maneuvers, turning of the pipes that after more than 80,000 actuation continue as the first day, corrosion-resistant chrome plating, anti-limescale plastics, brass and its alloys, etc ...

But above all, we want to talk to you about our commitment to quality and health, saving water and energy or the guarantee and technical assistance with which you will always find us by your side.

EC homologation and other specific certifications for markets in Belarus, Chile, Poland, Russia, Ukraine, Singapore and Saudi Arabia.

Grifería diseñada para edificios sostenibles

En GENE BRE desarrollamos productos pensados para mejorar el nivel de sostenibilidad de edificios y el confort de las personas, para que arquitectos, ingenieros y, en general, cualquier profesional de la construcción, puedan desarrollar sus proyectos de edificios sostenibles, saludables, respetuosos con el medio ambiente y que cumplan con la normativa vigente.

Taps designed for sustainable buildings

At GENE BRE we develop products that improve the level of sustainability of buildings and the comfort of people, so that architects, engineers and, in general, any construction professional, can develop their projects of sustainable, healthy, environmentally friendly buildings and that comply with current regulations.

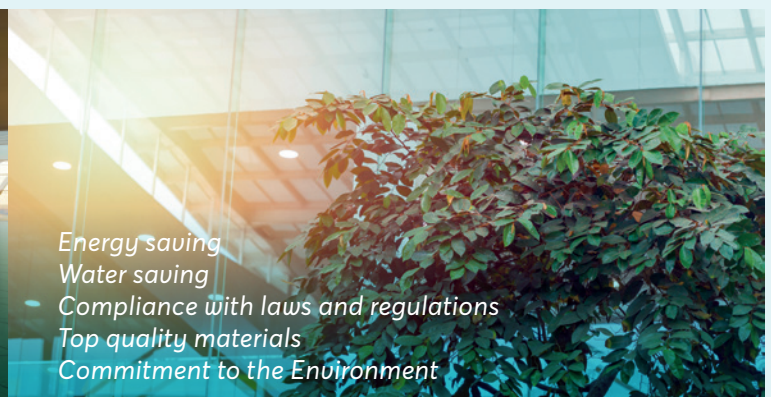



La grifería GENE BRE ayuda a cumplir y mejorar las certificaciones: GENE BRE taps help to comply and improve the certifications:

Certificación LEED (America) para la eficiencia con el consumo de agua, limitando el consumo máximo de litros por minuto o de litros por uso en el caso de temporizados.



LEED certification (America) for efficiency with water consumption, limiting the maximum consumption of liters per minute or liters per use in the case of timer.

Certificación DGNB (Alemania) para la evaluación y certificación de la sostenibilidad, que contempla aspectos medioambientales, económicos y socio-culturales de los edificios.



DGNB certification (Germany) for the evaluation and certification of sustainability, which considers environmental, economic and socio-cultural aspects of buildings.

Certificación BREEAM (Inglaterra) para la evaluación y certificación de la sostenibilidad en la edificación que actualmente ya cuenta con 600.000 edificios certificados en más de 90 países.



BREEAM certification (England) for the evaluation and certification of sustainability in buildings, which currently has 600,000 certified buildings in more than 90 countries.

La Certificación Edificio Sustentable (CES, Chile) para incentivar el diseño y la construcción de edificios con criterios de sustentabilidad y estimular el mercado para que valore este tipo de edificaciones.



The Sustainable Building Certification (CES, Chile) to encourage the design and construction of buildings with sustainability criteria and stimulate the market to value this type of buildings.

Certificación WELL sistema de puntuación dinámico para edificios y comunidades que permite identificar, medir y monitorizar las características de los espacios construidos que impactan en la salud y el bienestar de los ocupantes.



WELL certification, a dynamic scoring system for buildings and communities that allows to identify, measure and monitor the characteristics of the built spaces that impact on the health and well-being of the occupants

Certificación de Sustentabilidad (CS, Argentina) para dar visibilidad a las acciones relacionadas con el cuidado del Medio Ambiente y la Responsabilidad Social Empresarial.



Sustainability Certification (CS, Argentina) to give visibility to actions related to caring for the Environment and Corporate Social Responsibility.

Certificación Verde España: sistema de evaluación y certificación de la sostenibilidad. Un evaluador acreditado realiza la evaluación con la herramienta VERDE como paso previo a la certificación del edificio.



Green Spain Certification: sustainability evaluation and certification system. An accredited evaluator performs the evaluation with the GREEN tool as a preliminary step to the certification of the building.

*Porque un edificio sostenible es el que funciona bien hoy y en el futuro.
Because a sustainable building is one that works well today and in the future.*

Si tienes dudas o consultas, ponte en contacto con nuestro Departamento de Proyectos donde analizaremos tu caso en concreto y te ofreceremos un asesoramiento personalizado.

If you have questions or queries, get in touch with our Projects Department where we will analyze your specific case and offer you personalized advice.





Más opciones ecológicas

Presentamos los sistemas que incorporan las diferentes griferías de GENE BRE para ahorrar en el gasto de agua y energía. Novedades diseñadas especialmente para facilitar el uso y, a su vez, hacerlo más seguro y medioambientalmente sostenible.

Promoviendo la sensibilidad y el respeto por el medioambiente

GENEBRE es una compañía comprometida con el medioambiente. Su visión de un futuro sostenible y una filosofía enfocada en proteger el agua y los fluidos le permiten mejorar, investigar, desarrollar y crear conceptos innovadores a partir de las tecnologías más punteras. De manera que aplica siempre criterios que transmitan valores ecológicos en todos sus productos y a la vez que satisfagan las necesidades de funcionalidad, confort y diseño de los usuarios.

GENEBRE ha colaborado en el programa de I+D NUESVAL. Un estudio coordinado por el Centro Tecnológico de Manresa cuyo objetivo es desarrollar nuevas aleaciones de latón para válvulas de conducción de fluidos en condiciones ambientales de alta temperatura. Un modelo de proyecto basado en la innovación, en el que GENE BRE ha depositado su compromiso empresarial, con el fin de desarrollar tipos específicos de válvulas destinadas tanto a instalaciones domésticas como industriales..

More green options

The following user-friendly systems include the different GENE BRE taps that make for safer and more environmentally sustainable use, leading to financial savings in water expenditure and/or domestic energy.

Promoting respect for the environment

GENEBRE is a company committed to the environment. Its vision of a sustainable future and a philosophy focused on protecting water and fluids allow it to improve, research, develop and create innovative concepts using the most advanced technologies. GENE BRE always applies the same criteria which transmits ecological values in all of its products, and at the same time satisfies the users' needs of functionality, comfort, and design.

GENEBRE has collaborated el programa de I+D NUESVAL, a study coordinated by the Centro Tecnológico de Manresa, whose objective is to develop new brass and bronze alloy for valves. It is a project model based on innovation, in which GENE BRE reinforces its commitment to developing specific types of valves for domestic as well as industrial installations.



Ahorro de agua Water saving
Ahorro energético Energy saving
Medio ambiente Environment
Sostenibilidad Sustainability



Sistema GE-ECO.
En las series Koral, Kode,
Klip, Kelogic, Tau y Oslo.

GE-ECO system.
In Koral, Kode, Klip, Kelogic,
Tau and Oslo series.



Sistema GE-COLD START.
En las series Kelogic, Tau
y Oslo.

GE-COLD START.
In Kelogic, Tau y Oslo series.



Gran variedad de economizadores.
A wide range of economizers.



Sistemas de filtrado.
En las serie Tau Cocinas.

Filtration systems.
In Tau Kitchen serie.



Tecnología

Presentamos los sistemas que incorporan las diferentes griferías de GENE BRE para ahorrar en el gasto de agua y energía. Novedades diseñadas especialmente para facilitar el uso y, a su vez, hacerlo más seguro y medioambientalmente sostenible.



GE-ECO

- Economizador de agua.
- Ahorro de energía.
- Water economizer.
- Energy saving.

Technology

The following user-friendly systems include the different GENE BRE taps that make for safer and more environmentally sustainable use, leading to financial savings in water expenditure and/or domestic energy.



GE-2P

Apertura del grifo en dos posiciones:

- Primera posición: **ahorro del 50% de agua.**
- Segunda posición: pleno caudal.

Two-position opening of the tap:

- First position: **supplies 50% less water.**
- Second position: full flow.



Ref.: 62136 08 45 66

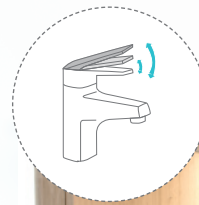

Ref.: 64134 32 45 66



GE-COLD START

- **Gran ahorro energético:**
evita que se active caldera, calentador o termo eléctrico indebidamente.
- **Great deal of energy:**
prevents boiler, heater or electric boiler from being activated unduly.



GE-SAFE

- **Prevención ante quemaduras:**
limita a 38°C el caudal de agua caliente, y asegura el corte de agua para evitar quemaduras en caso de fallo del suministro de agua fría.
- **Prevention against burns:**
limits and ensures hot water cuts off at a maximum temperature of 38°C, avoiding burns in the event of a cut in the cold-water supply.





Novedades 2021

News 2021

Autonomía total

Total Freestanding

Grifos de pie para bañeras exentas, que le darán a tu baño un toque diferente, independiente, exclusivo y sofisticado, para convertirlo en el mejor rincón donde relajarse, aislarse y desconectar de todo.

Floor-standing taps for freestanding baths, which will give your bathroom a different, independent, exclusive and sophisticated touch, to transform it into the best space where relax, isolate and disconnect from everything.



El negro está de moda

Black is back

Elegancia y sobriedad. Una nueva opción con la que tu baño tendrá un aire muy actual y con mucha personalidad.

Elegance and sobriety. A new option with which your bathroom will have a very modern feel, with plenty of personality.



**Nueva distribución del catálogo,
con secciones específicas para baño y cocina,
mucho más intuitiva y fácil de utilizar.**

New distribution of the catalogue,
with specific sections for bathroom and kitchen,
much **more intuitive and easy to use.**





Ref.: 63119 26 45 66



Baños

Bathroom



Grifería a la altura perfecta

Porque cada baño es distinto y personal, en Genebre ponemos a tu disposición diferentes alturas en todos nuestros grifos de las colecciones Kode, Oslo, Tau, Tau2, Koral, Klip, Klip2, Kelogic, Kenjo y K8, fabricadas siempre de una sola pieza, aportando un plus de diseño y robustez.

Tú eliges. La altura convencional de toda la vida para lavarse las manos, o una altura media, alta, empotrada o de pie con los que también podrás llenar recipientes, lavarte el pelo o darle a tu baño ese toque de diseño que estabas buscando.

Taps at the perfect height

Because each bathroom is different and personal, at Genebre we offer you different heights in all our taps from the Kode, Oslo, Tau, Tau2, Koral, Klip, Klip2, Kelogic, Kenjo and K8 collections, all of them manufactured in one piece providing a plus of design and robustness.

It's your choice. The conventional height to wash your hands, or a medium, high, recessed or standing height with which you can also fill containers, wash your hair or give your bathroom that touch of design that you were looking for.

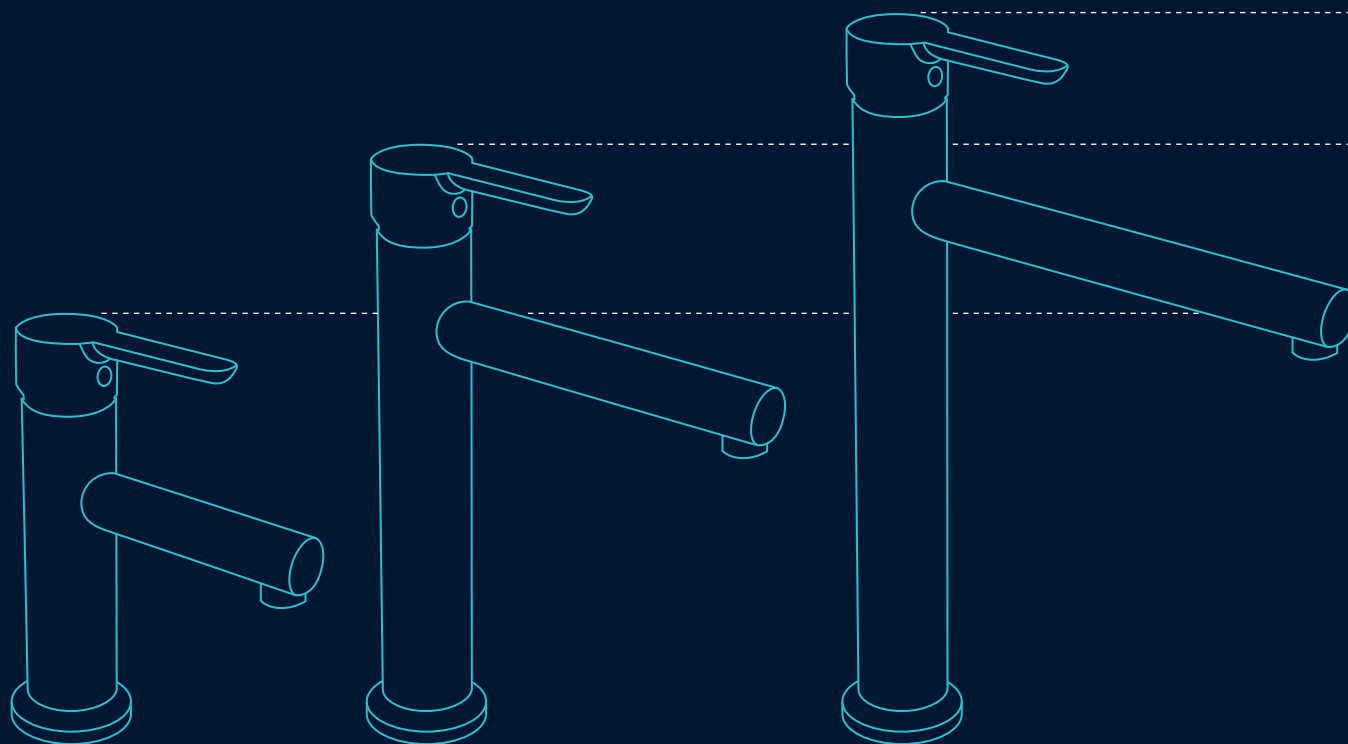

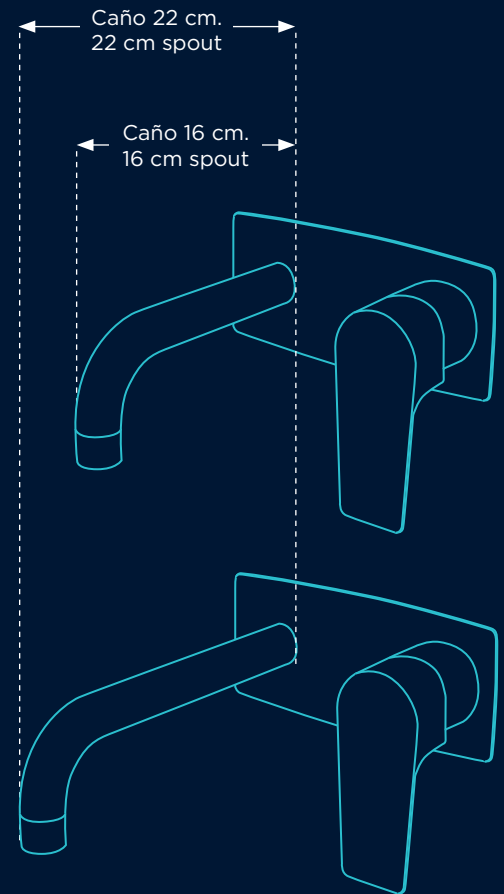
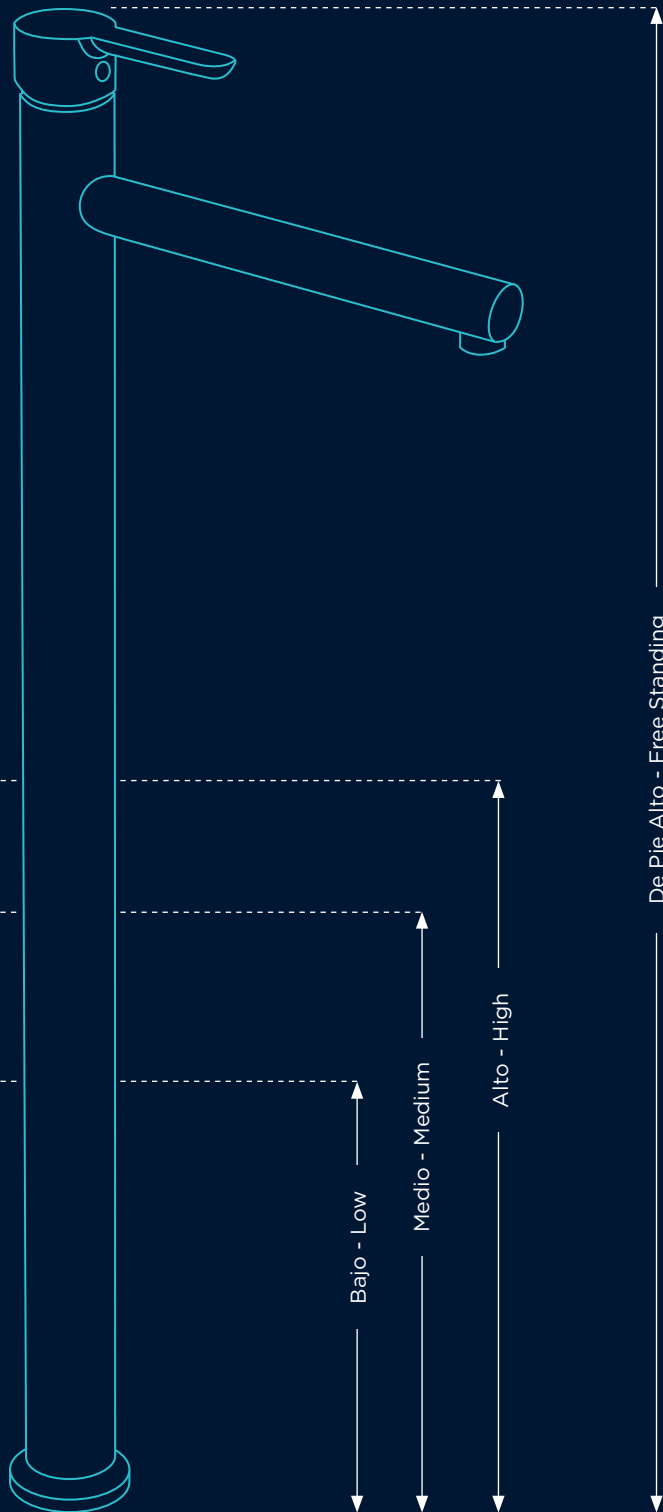

Genebre: soluciones a medida y máximo confort para cada lavabo, ya sea empotrado, sobre encimera, normal o tipo bol.

Genebre: tailor-made solutions and maximum comfort for each washbasin, whether built-in, countertop, normal or bowl-type.



Ref.: 64136 32 45 66



Koral



Relájate.

Siente tu respiración. Deja que el agua acaricie todos tus poros, y disfruta de las sinuosas líneas y el estilo propio de la nueva Serie Koral.

Relax.

Feel your breath. Let the water caress all your pores, and enjoy the sinuous lines of the new Koral Series.

Koral



Monomando de lavabo
Single lever wash-basin mixer
Ref.: 64130 32 45 66



Monomando de lavabo medio alto
Medium height single lever wash-basin mixer
Ref.: 64134 32 45 66



Monomando de lavabo alto
High single lever wash-basin mixer
Ref.: 64136 32 45 66





**Monomando de lavabo empotrado
caño 16 cm**
Built-in wash-basin mixer 16 cm spout
Ref.: 64131 32 45 66



**Monomando de lavabo empotrado
caño 22 cm**
Built-in wash-basin mixer 22 cm spout
Ref.: 64132 32 45 66



Monomando de bidé
Single lever bidet mixer
Ref.: 64140 32 45 66



Monomando de bidé con transmisión
Single lever bidet mixer with diverter
Ref.: 64142 32 45 66

La grifería GENE BRE está diseñada y fabricada según los estándares europeos de calidad, como la UNE-EN 19703 ofreciendo la funcionalidad, durabilidad y seguridad esperadas.

GENEBRE taps are designed and manufactured according to European quality standards, such as UNE-EN 19703, offering the expected functionality, durability and safety.

Koral



Monomando de ducha con kit *
Single lever shower mixer with kit *
Ref.: 64110 32 45 66



Monomando de baño con kit *
Single lever bath mixer with kit *
Ref.: 64100 32 45 66



*** Kit incluido**
* Kit included

Mango de ducha C1 jet
C1 jet handshower
Ref.: 100197 45 00

Flexo H 1/2" - H 1/2" 1,70 m inoxidable
F 1/2" - F 1/2" Stainless steel flexible hose 1.70 m
Ref.: 100135 60 00

Soporte ducha cilíndrico
Cylindrical shower holder
Ref.: 100153 45



Se crean 5 variantes de monomando para bañera exenta, y un juego de columnas equipables con la grifería a escoger. Todas las variantes poseen un sistema de regulación único, el cuál nos ayudará a instalarlo totalmente perpendicular y alineado perfectamente con la bañera.

5 variants of single-lever bath for exempt bathtub are created, and a set of columns that can be equipped with the taps to be selected. All the variants have a unique regulation system, which will help us to install it completely perpendicular and perfectly aligned with the bathtub.

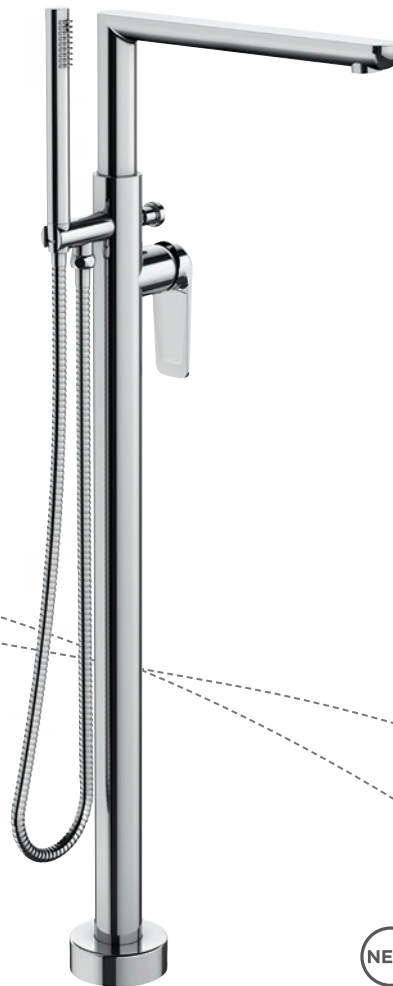

NEW

Monomando de pie para bañera
Floor single lever mixer for bath
Ref.: 64119 32 45 66



Ref.: 64119 32 45 66

Koral



Monomando de ducha empotrado

Built-in single lever shower mixer

Ref.: 64115 32 45 66



Monomando empotrado con inversor 2 vías

2 way Built-in single lever mixer with diverter

Ref.: 64116 32 45 66



Monomando empotrado con inversor cerámico 2 vías

Built-in single lever mixer with 2-way ceramic diverter

Ref.: 64117 32 45 66



Monomando empotrado con inversor cerámico 3 vías

Built-in single lever mixer with 3-way ceramic diverter

Ref.: 64118 32 45 66



Inversor cerámico 3 vías empotrado

Built-in 3-way ceramic diverter

Ref.: 64114 30 45 66



GE-EASY: UNIC Control



Un innovador concepto de columna de ducha extensible que incorpora un sistema de doble función en la maneta, desde donde accionar el rociador o el mango de ducha.

An innovative concept of extendable shower column that incorporate a dual function system in the actuator from which to operate the shower head or shower handle.

UNIC Control:

Temperatura. Temperature.
Caudal. Flow.
Inversor. Inverter.

- A** Función rociador. Shower head function.
- B** Función mango de ducha. Handshower function.
- C** Stop.



Columna monomando extensible con kit
Single lever extendable column with kit
Ref.: CM64110 32

Kode



Robustez estilizada.

Inspirada en las nuevas tendencias, la nueva serie Kode deja entrever un estilo robusto y dinámico de maneta prominente con formas redondeadas que la matizan. Un magnífico diseño de alta gama creada para los baños de última generación.

Acabado cromado. Cartucho 40
Chromed finish. Cartridge 40

Stylized robustness.

Inspired in new trends, the new Kode series reveals a robust, dynamic style with a prominent handle with round forms that match. A magnificent high-end design created for new generation bathrooms.





Ref.: 62136 08 45 66

Kode



Monomando de lavabo
Single lever wash-basin mixer
Ref.: 62130 08 45 66



Monomando de lavabo alto
High single lever wash-basin mixer
Ref.: 62136 08 45 66





**Monomando de lavabo empotrado
caño 16 cm**
Built-in wash-basin mixer
16 cm spout
Ref.: 62131 31 45 66



**Monomando de lavabo empotrado
caño 22 cm**
Built-in wash-basin mixer
22 cm spout
Ref.: 62132 31 45 66



Monomando de bidé
Single lever bidet mixer
Ref.: 62140 08 45 66



Monomando de bidé con transmisión
Single lever bidet mixer with diverter
Ref.: 62142 31 45 66



Kode



Monomando de baño sin kit
Single lever bath mixer without kit
Ref.: 62100 08 45 67



Monomando de ducha sin kit
Single lever shower mixer without kit
Ref.: 62110 31 45 67



*** Kit de ducha recomendado:**
* Recommended shower kit:

Mango de ducha O3 jets
O3 jets handshower
Ref.: DXO3 45

**Flexo extensible H 1/2" - H 1/2" 1,70 - 2,25 m
inoxidable F 1/2" - F 1/2"**
Extensible stainless steel flexible hose
1.70 to 2.25 m
Ref.: 100137 60 00

Soporte ducha ovalado
Oval shower holder
Ref.: 100068 45



Monomando de pie para bañera Kode
Kode Floor single lever mixer for bath
Ref.: 62119 31 45 66





Monomando de ducha empotrado
Built-in single lever shower mixer
Ref.: 62115 31 45 66



Monomando empotrado con inversor cerámico 2 vías
Built-in single lever mixer with 2 way ceramic diverter
Ref.: 62117 31 45 66



Monomando empotrado con inversor cerámico 3 vías
Built-in single lever mixer with 3 way ceramic diverter
Ref.: 62118 31 45 66



Inversor cerámico 3 vías empotrado con placa ovalada
Built-in 3 way ceramic diverter with oval plate
Ref.: 62114 30 45 66



Kode



Inversor cerámico 3 vías empotrado con placa ovalada

Built-in 3 way ceramic diverter with oval plate
Ref.: 62114 30 45 66

Monomando de ducha empotrado

Built-in single lever shower mixer
Ref.: 62115 31 45 66

Rociador doble función cascada-lluvia

Shower head double function waterfall-rain
Ref.: 1643 45

Toma ducha mural redonda

Round wall connector
Ref.: 1680 04

Barra ducha TAU

TAU shower bar
Ref.: 1636 45

Flexo extensible

H 1/2" - H 1/2" 1,70 - 2,25 m inoxidable
F 1/2" - F 1/2" Extensible stainless steel flexible hose 1.70 to 2.25 m
Ref.: 100137 60 00

Mango de ducha O3 jets

O3 jets handshower
Ref.: DXO3 45



Monomando empotrado con inversor cerámico 3 vías

Built-in single lever mixer with 3 way ceramic diverter
Ref.: 62118 31 45 66

Brazo pared redondo 35 cm

Round wall arm 35 cm
Ref.: B65113 18

Rociador D22 ovalado

Oval D22 shower sprayer
Ref.: R63112 08

Toma ducha mural redonda

Round wall connector
Ref.: 1680 04

Barra ducha TAU

TAU shower bar
Ref.: 1636 45

Flexo extensible

H 1/2" - H 1/2" 1,70 - 2,25 m inoxidable
F 1/2" - F 1/2" Extensible stainless steel flexible hose 1.70 to 2.25 m
Ref.: 100137 60 00

Mango de ducha O3 jets

O3 jets handshower
Ref.: DXO3 45

Caño mural baño cilíndrico

Round wall bath spout
Ref.: 1668 45





Oslo



Vanguardismo y sencillez.

Una línea estilizada de formas depuradas y ángulos rectos es la base de la serie Oslo. Una nueva colección con diferentes alturas de caños, que proyecta elegancia y esbeltez y un avanzado diseño vanguardista donde cada detalle está pensado para embellecer el baño.

Acabado cromado. Cartucho 35.
Chromed finish. Cartridge 35.

Vanguardism and simplicity.

A stylized line of pure forms and right angles is the basis of the Oslo series. A new collection, with different spout heights, which projects elegance and slenderness, and has an advanced vanguardist design where each detail is intended to beautify the bathroom.





GENEBREDO
1996
Ref.: 65136 19 45 66

Oslo



Taladro para válvula automática de varilla en las 3 alturas
Drill for automatic rod valve in the 3 heights



Monomando de lavabo
Single lever wash-basin mixer
Ref.: 65130 19 45 66



Monomando de lavabo medio alto
Medium height single lever wash-basin mixer
Ref.: 65134 19 45 66



Monomando de lavabo alto
High single lever wash-basin mixer
Ref.: 65136 19 45 66



Ref.: 65130 19 45 66



Monomando de lavabo empotrado caño 16 cm
Built-in wash-basin mixer 16 cm spou
Ref.: 65131 19 45 66



Monomando de lavabo empotrado caño 22 cm
Built-in wash-basin mixer 22 cm spout
Ref.: 65132 19 45 66



Monomando de bidé
Single lever bidet mixer
Ref.: 65140 19 45 66



Monomando de bidé con transmisión
Single lever bidet mixer with diverter
Ref.: 65142 19 45 66



Set mezclador sanitario de ducha con soporte
Sanitary shower mixer set with support
Ref.: 65144 19 45 66

Oslo

NUEVA LÍNEA / NEW LINE Monomandos de pie para lavabo Floor single lever mixer for basin

Los grifos monomando de pie encuentran su lugar en espacios modernos y vanguardistas. Una estilizada línea que aportará diferencia y sofisticación.

Floor-standing mixer taps find their place in modern and avant-garde spaces. A stylized line that will bring difference and sophistication.



Para una instalación totalmente perpendicular y alineado.

Completely perpendicular and perfectly aligned installation.



NEW

Monomando de Pie para lavabo
Floor single lever mixer for basin
Ref.: 65139 19 45 66



NEW

Monomando de Pie para lavabo
Floor single lever mixer for basin
Ref.: 65139 19 41 66

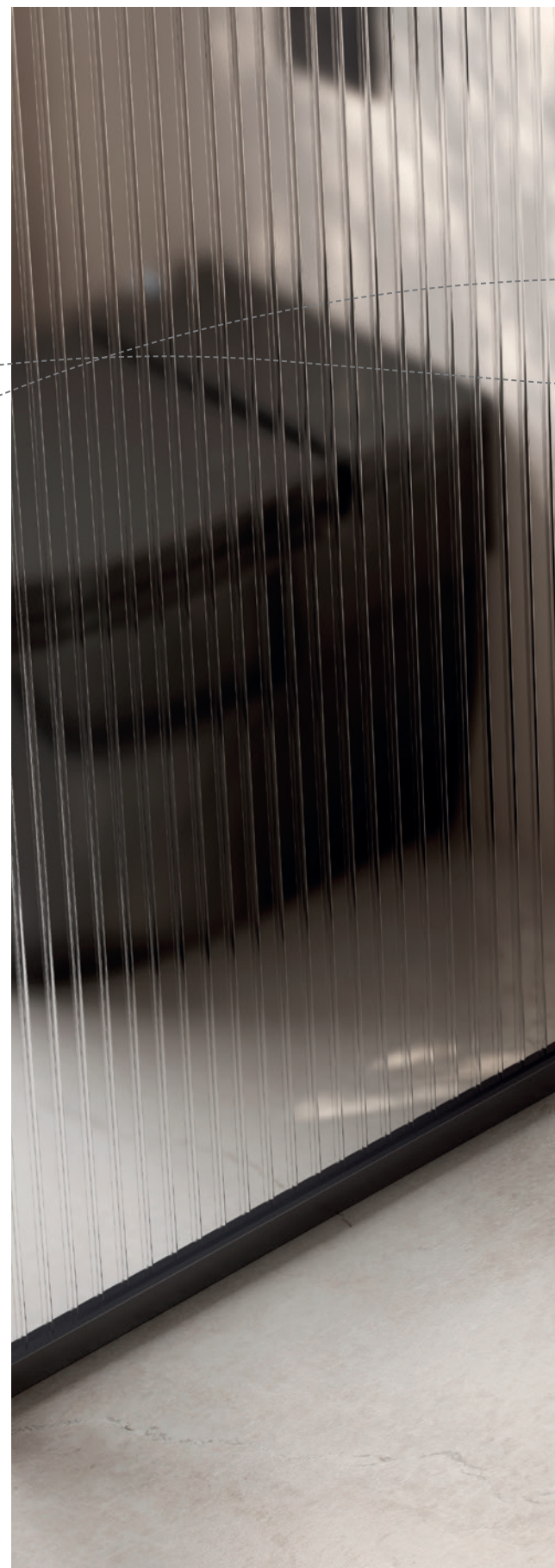



Ref.: 65139 19 41 66

Serie **Oslo**

Oslo



Monomando de baño con kit *
Single lever bath mixer with kit *
Ref.: 65100 19 45 66



Monomando de ducha con kit *
Single lever shower mixer with kit *
Ref.: 65110 19 45 66



*** Kit incluido**
* Kit included

Mango de ducha C1 jet
C1 jet handshower
Ref.: 100197 45 00

Flexo H 1/2" - H 1/2" 1,70 m inoxidable
F 1/2" - F 1/2" Stainless steel flexible hose 1.70 m
Ref.: 100135 60 00

Soporte ducha cilíndrico
Cylindrical shower holder
Ref.: 100153 45





Monomando de ducha empotrado
Built-in single lever shower mixer
Ref.: 65115 19 45 66

Monomando empotrado con inversor 2 vías
2 way Built-in single lever mixer with diverter
Ref.: 65116 19 45 66



Oslo

* Kit de ducha empotrado Oslo
* Oslo Built-in shower kit



Brillo
Brilliance



Apertura suave
Soft opening



Kit de accesorios
Accessory Kit



Latón
Brass



NEW

Kit de ducha empotrado Oslo *
Oslo Built-in shower kit *
Ref.: ST116 19



Consulte la ficha técnica de nuestros productos: Para encontrar toda la información técnica de cualquier producto, localice la referencia del artículo al final de este catálogo, o en nuestra web.

Consult data sheet of our products: Use the item reference to find all of the technical information on any of our products, at the end of this catalogue or our web.



Set columna fija con kit *
Fixed column set with kit *
Ref.: 1744 45



Columna monomando fija con kit *
Single lever fixed column with kit *
Ref.: CM65110 19



Columna termostática fija con kit *
Thermostatic fixed column with kit *
Ref.: CT67110 19





Serie **Oslo Black / Black Oslo**



Oslo Black Black Oslo



El negro está de moda.

Elegancia y sobriedad. Una nueva opción con la que tu baño tendrá un aire muy actual y con mucha personalidad.

Black is fashionable.

Elegance and sobriety. A new option with which your bathroom will have a very modern feel, with plenty of personality.

Oslo Black



Taladro para válvula automática de varilla en las 3 alturas
Drill for automatic rod valve in the 3 heights



Monomando de lavabo
Single lever wash-basin mixer
Ref.: 65130 19 41 66



Monomando de lavabo medio alto
Medium height single lever wash-basin mixer
Ref.: 65134 19 41 66



Monomando de lavabo alto
High single lever wash-basin mixer
Ref.: 65136 19 41 66



Monomando de lavabo empotrado caño 16cm
Built-in wash-basin mixer 16 cm spout
Ref.: 65131 19 41 66



Monomando de lavabo empotrado caño 22cm
Built-in wash-basin mixer 22 cm spout
Ref.: 65132 19 41 66

Ref.: 65134 19 41 66



Serie Oslo Black / Black Oslo

Oslo Black



Monomando de bidé
Single lever bidet mixer
Ref.: 65140 19 41 66



Monomando de bidé con transmisión
Single lever bidet mixer with diverter
Ref.: 65142 19 41 66



Monomando de baño con kit *
Single lever bath mixer with kit *
Ref.: 65100 19 41 66



Monomando de ducha con kit*
Single lever shower mixer with kit *
Ref.: 65110 19 41 66



*** Kit incluido**
* Kit included

Mango de ducha 3 jets negro
Black 3 jets hand shower
Ref.: 9908 0284

Flexo H 1/2" - H 1/2" 1,70 m inoxidable negro
F 1/2" - F 1/2" Black stainless steel
flexible hose 1.70 m
Ref.: 9908 0287

Soporte ducha Negro
Black Shower holder
Ref.: 9908 0286



NEW

Monomando de baño empotrado con inversor
Built-in single lever bath mixer with diverter
Ref.: 65116 19 41 66



NEW

Monomando empotrado con inversor 2 vías
2 way Built-in single lever mixer with diverter
Ref.: 65115 19 41 66



NEW

Mezclador sanitario de ducha con soporte Negro
Black Sanitary shower mixer with support
Ref.: 65144 19 41 67



NEW

Kit ducha sanitaria Negro
Black Sanitary shower kit
Ref.: 100694 41

La grifería GENE BRE está diseñada y fabricada según los estándares europeos de calidad, como la UNE-EN 19703 ofreciendo la funcionalidad, durabilidad y seguridad esperadas.

GENEBRE taps are designed and manufactured according to European quality standards, such as UNE-EN 19703, offering the expected functionality, durability and safety.

Oslo Black



Columna monomando extensible con kit
Single lever extensible column with kit
Ref.: CM65111 19 41



Columna termostática extensible con kit
Thermostatic extensible column with kit
Ref.: CT67111 19 41



Set columna fija con kit
Fixed column set with kit
Ref.: 1744 41

Consulte la ficha técnica de nuestros productos: Para encontrar toda la información técnica de cualquier producto, localice la referencia del artículo al final de este catálogo, o en nuestra web.

Consult data sheet of our products: Use the item reference to find all of the technical information on any of our products, at the end of this catalogue or our web.





Serie **Oslo Black** / **Black Oslo**

Oslo Black



NEW

Rociador D22 Oslo Black
Oslo Black D22 shower head
Ref.: R65112 41

Brazo a techo redondo 15 cm negro
Black round roof arm 15 cm
Ref.: 1671 41



NEW

Brazo pared redondo 35 cm negro
Black round wall arm 35 cm
Ref.: B64113 41

Rociador D22 Oslo Black
Oslo Black D22 shower head
Ref.: R65112 41



NEW

Soporte de ducha cilíndrico con toma 1/2" Negro
Black Cylindrical shower holder with 1/2" connector
Ref.: 1946 41





NEW

Mango de ducha 3 jets negro
Black 3 jets hand shower
Ref.: 9908 0284



NEW

Flexo H 1/2" - H 1/2" 1,70 m inoxidable negro
F 1/2" - F 1/2" Black stainless steel
flexible hose 1.70 m
Ref.: 9908 0287



NEW

Válvula universal click Luxe con y sin rebosadero Negro
Black luxe universal click pop-up waste
with and without overflow
Ref.: 100211 41

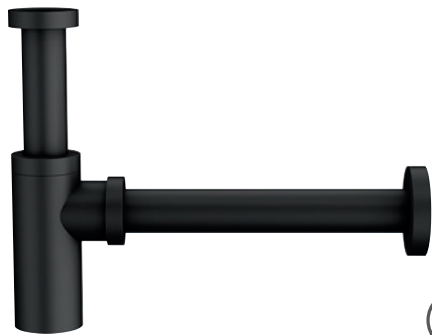

NEW

Sifón botella para lavabo y bidé 1 1/4" negro
Black 1 1/4" bidet and basin siphon
Ref.: 1626 41



NEW

Válvula de escuadra redonda 3/8" Negro
Black Round angle valve 3/8"
Ref.: 3110 03 41



NEW

Caño mural baño cilíndrico Negro
Black Round wall bath spout
Ref.: 1668 41

Opcional In option

Tubo alargado vertical sifón 1 1/4" negro
Black vertical enlarge tube 1 1/4" siphon
Ref.: 1632 41

Tubo alargado horizontal sifón 1 1/4" Negro
Black horizontal enlarge tube 1 1/4" siphon
Ref.: 1640 41



Ref.: 64136 16 45 66

Klip



Siempre actual.

De líneas rectas y casi cuadradas ofrece un diseño sugerente que se integra con las tendencias de decoración de las cocinas y baños más modernos. Robusta, resistente y de belleza discreta, la colección Klip es una de nuestras colecciones más solicitadas.

Stylized robustness.

Straight, almost square lines offer a suggestive design that combines with the most modern decoration trends for kitchens and bathrooms. Robust, and resistant in its discreet beauty, the Klip series is one of our most sought after collections.

Acabado cromado. Cartucho 40.
Chromed finish. Cartridge 40.

Klip



Monomando de lavabo
Single lever wash-basin mixer
Ref.: 64130 16 45 66



Monomando de lavabo medio alto
Medium height single lever wash-basin mixer
Ref.: 64134 16 45 66



Monomando de lavabo alto
High single lever wash-basin mixer
Ref.: 64136 16 45 66



Monomando de lavabo empotrado caño 16 cm
Built-in wash-basin mixer 16 cm spout
Ref.: 64131 16 45 66



Monomando de lavabo empotrado caño 22 cm
Built-in wash-basin mixer 22 cm spout
Ref.: 64132 16 45 66



Monomando de bidé
Single lever bidet mixer
Ref.: 64140 16 45 66



Monomando de bidé con transmisión
Single lever bidet mixer with diverter
Ref.: 64142 16 45 66



Monomando de baño con kit *
Single lever bath mixer with kit *
Ref.: 64100 16 45 66



Monomando de ducha con kit *
Single lever shower mixer with kit *
Ref.: 64110 16 45 66



*** Kit incluido**
* Kit included

Mango de ducha C1 jet
C1 jet handshower
Ref.: 100197 45 00

Flexo H 1/2" - H 1/2" 1,70 m inoxidable
F 1/2" - F 1/2" Stainless steel flexible hose 1.70 m
Ref.: 100135 60 00

Soporte ducha cilíndrico
Cylindrical shower holder
Ref.: 100153 45

Klip



Monomando de ducha empotrado

Built-in single lever shower mixer

Ref.: 64115 16 45 66



Monomando empotrado con inversor 2 vías

2 way Built-in single lever mixer with diverter

Ref.: 64116 16 45 66



Termostática baño

Thermostatic bath mixer

Ref.: 67103 14 45 67



Termostática ducha

Thermostatic shower mixer

Ref.: 67104 14 45 67



Monomando empotrado con inversor 2 vías
2 way Built-in single lever mixer with diverter
Ref.: 64116 16 45 66

Brazo a techo redondo 15 cm
Round roof arm 15 cm
Ref.: 1671 45

Rociador redondo 22 cm
Round shower head Ø 22 cm
Ref.: R65112 18

Toma ducha mural redonda
Round wall connector
Ref.: 1680 04

Conjunto Tau, barra, flexo y ducha 5 jets
Tau set, bar, hose and 5 jets handshower
Ref.: 1748 45

Termostática baño
Thermostatic bath mixer
Ref.: 67103 14 45 67

Set columna con ducha, soporte y flexo
Column set with shower, holder and flexible hose
Ref.: 1745 45



Ref.: 64134 04 45 66

Kelogic



Ahorra agua, ahorra energía.

Innovación, tecnología y responsabilidad medioambiental se fusionan en la serie más ecológica de su gama. Su innovador sistema de apertura en frío que ayuda a ahorrar agua y energía la hace totalmente sostenible. Además, es muy cómoda porque el caudal se regula con mayor facilidad. Una colección ideal para el nuevo estilo de vida.

Acabado cromado. Cartucho 40.
Chromed finish. Cartridge 40.

Save water, save energy.

Innovation, technology and environmental responsibility merge in the most ecological series of its range. The innovative cold opening system helps to save water and energy, making it totally sustainable. In addition, it is very comfortable because the flow is regulated much more easily. An ideal collection for a new style of life.

Kelogic

La serie más ecológica The most environmental-friendly series

Apertura en frío Kelogic

La principal característica de esta serie es el ahorro de energía. Al abrir el grifo en su posición central, únicamente saldrá agua fría. El agua caliente no saldrá mientras no giremos la maneta hacia la izquierda. De este modo, nuestro sistema Kelogic evita que su caldera o calentador se ponga en marcha innecesariamente.

Cold start, Kelogic

The main advantage of this serie is energy savings. When you open the tap from its central position, only cold water is used, and hot water only flows when the level is moved to the left. Energy is saved because our Kelogic system switches on the water heater only when necessary.



GE-COLD START

Serie **Kelogic**



- 1 Inversor y racor ducha metálico.
Metallic shower diverter and adapter.
- 2 Sistema anti retorno con limitador de caudal dinámico.
Stop return valves with dynamic flow restrictor.
- 3 Flexible de alta resistencia, con sistema "anti-lock" y antibacteriano.
High-resistant, flexible, antibacterial hose with anti-lock system.



- 4 Apertura en frío.
Cold start.
- 5 Cartucho economizador 2 posiciones.
2-position cartridge saver.
- 6 Atomizador economizador de agua.
Spray water economizer.



Ahorro de agua
Water savings



Ahorro de energía
Energy savings



Ahorro anual
Annual savings

Calentador eléctrico.
Electric heater.

Vivienda para cuatro personas
con calentador eléctrico.

Apartment for four people
with electric heater.



Ahorro de agua
Water savings

71,8 m³



Ahorro de energía
Energy savings

181,4 Kw

Calentador de gas.
Gas heater.

Vivienda para cuatro personas
con calentador de gas.

Apartment for four people
with gas heater.



Ahorro de agua
Water savings

71,8 m³



Ahorro de energía
Energy savings

51,2 m³

Caldera de gas.
Gas boiler.

Hotel de 100 habitaciones dobles
con caldera de gas.

Hotel with 100 double rooms
with gas boiler.



Ahorro de agua
Water savings

3337 m³



Ahorro de energía
Energy savings

2379 m³

*** **Valores de consumo medio diario** Average daily consumption values

4 aperturas en lavabo
openings in basin + **1** ducha por persona
shower per person

duración
duration **35"**

consumo
monomando lavabo
consumption
single lever
wash-basin mixer **12 l/min**

duración
duration **6'** temperatura
temperature **38°**

agua caliente
hot water **85%** agua fría
cold water **15%**

consumo monomando de ducha
consumption single lever
wash-basin mixer **9 l/min**

uso en agua caliente
use in hot water **30%**

Kelogic



Monomando de lavabo apertura en frío
Single lever wash-basin mixer cold start
Ref.: 64130 04 45 66



Monomando lavabo medio alto apertura en frío
Medium height single lever wash-basin mixer cold start
Ref.: 64134 04 45 66



Monomando lavabo alto apertura en frío
High single lever wash-basin mixer cold start
Ref.: 64136 04 45 66



Monomando bidé apertura en frío
Single lever bidet mixer cold start
Ref.: 64140 04 45 66



Monomando de bidé con transmisión
Single lever bidet mixer with diverter
Ref.: 64142 16 45 66



Monomando de baño con kit *
Single lever bath mixer with kit *
Ref.: 64100 04 45 66



Monomando de ducha con kit *
Single lever shower mixer with kit *
Ref.: 64110 04 45 66



*** Kit incluido**
* Kit included

Mango de ducha C1 jet
C1 jet handshower
Ref.: 100197 45 00

Flexo H 1/2" - H 1/2" 1,70 m. PVC antirrotura
F 1/2" - F 1/2" PVC flexible hose 1.70 m
anti-breaking
Ref.: 100140 30

Soporte ducha cilíndrico
Cylindrical shower holder
Ref.: 100153 45



Kelogic



Monomando de ducha empotrado
Built-in single lever shower mixer
Ref.: 64115 16 45 66



Monomando empotrado con inversor cerámico 2 vías
Built-in single lever mixer with 2-way ceramic diverter
Ref.: 64117 04 45 66



Monomando empotrado con inversor cerámico 3 vías
Built-in single handle mixer with 3-way ceramic diverter
Ref.: 64118 04 45 66



Inversor cerámico 3 vías empotrado con placa cuadrada
Built-in 3-way ceramic diverter with square plate
Ref.: 65114 30 45 66

Consulte la ficha técnica de nuestros productos: Para encontrar toda la información técnica de cualquier producto, localice la referencia del artículo al final de este catálogo, o en nuestra web.

Consult data sheet of our products: Use the item reference to find all of the technical information on any of our products, at the end of this catalogue or our web.







Ref.: CT67110 18



Tau



Espacios con carácter.

Bella y seductora, la serie Tau transforma la cocina y el baño en espacios con estilo. Concebida a partir de un concepto de líneas cilíndricas y curvas estilizadas que realzan su silueta, cuenta con una gran gama de versiones que permiten adaptarla a todos los ambientes.

Acabado cromado. Cartucho 40.
Chromed finish. Cartridge 40.

Spaces with character.

Beautiful and seductive, the Tau series transforms the kitchen and bathroom into spaces with style. Conceived from cylindrical lines and stylized curves that highlight its silhouette, there is a large variety that adapts to all types of ambiances.

Tau



Monomando de lavabo
Single lever wash-basin tap
Ref.: 65135 18 45 66



Monomando de lavabo medio alto
Medium height single lever wash-basin mixer
Ref.: 65134 18 45 66



Monomando de lavabo alto
High single lever wash-basin mixer
Ref.: 65136 18 45 66



Monomando de lavabo apertura en frío
Single lever wash-basin tap cold start
Ref.: 65138 18 45 66



Monomando de lavabo empotrado caño 16 cm
Built-in wash-basin mixer 16 cm spout
Ref.: 65131 18 45 66

Monomando de lavabo empotrado caño 22 cm
Built-in wash-basin mixer 22 cm spout
Ref.: 65132 18 45 66



Monomando de bidé
Single lever bidet mixer
Ref.: 65145 18 45 66



Monomando de bidé con transmisión
Single lever bidet mixer with diverter
Ref.: 65142 18 45 66

La grifería GENE BRE está diseñada y fabricada según los estándares europeos de calidad, como la UNE-EN 19703 ofreciendo la funcionalidad, durabilidad y seguridad esperadas.

GENEBRE taps are designed and manufactured according to European quality standards, such as UNE-EN 19703, offering the expected functionality, durability and safety.

Tau



Monomando de baño con kit *
Single lever bath mixer with kit *
Ref.: 65100 18 45 66



Monomando de ducha con kit *
Single lever shower mixer with kit *
Ref.: 65110 18 45 66



*** Kit incluido**
* Kit included

Mango de ducha C1 jet
C1 jet handshower
Ref.: 100197 45 00

Flexo H 1/2" - H 1/2" 1,70 m inoxidable
F 1/2" - F 1/2" Stainless steel flexible hose 1.70 m
Ref.: 100135 60 00

Soporte ducha cilíndrico
Cylindrical shower holder
Ref.: 100153 45



Monomando de pie para bañera Tau
Tau Floor single lever mixer for bath
Ref.: 65119 18 45 66

NEW



Se crean 5 variantes de monomando para bañera exenta, y un juego de columnas equipables con la grifería a escoger. Todas las variantes poseen un sistema de regulación único, el cuál nos ayudará a instalarlo totalmente perpendicular y alineado perfectamente con la bañera.

5 variants of single-lever bath for exempt bathtub are created, and a set of columns that can be equipped with the taps to be selected. All the variants have a unique regulation system, which will help us to install it completely perpendicular and perfectly aligned with the bathtub.



Tau



Monomando de ducha empotrado
Built-in single lever shower mixer
Ref.: 65115 18 45 66



Monomando empotrado con inversor 2 vías
2 way Built-in single lever mixer with diverter
Ref.: 65116 18 45 66



Monomando empotrado con inversor cerámico 2 vías
Built-in single lever mixer with 2-way ceramic diverter
Ref.: 65117 18 45 66



Monomando empotrado con inversor cerámico 3 vías
Built-in single lever mixer with 3-way ceramic diverter
Ref.: 65118 18 45 66



NEW

Inversor cerámico 3 vías empotrado con placa cuadrada
Built-in 3-way ceramic diverter with square plate
Ref.: 65114 30 45 66

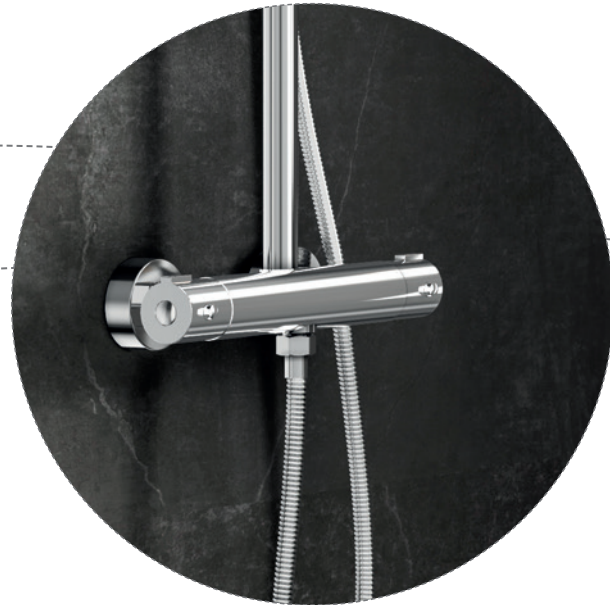

Termostática baño
Thermostatic bath mixer
Ref.: 67102 14 45 67



Termostática ducha
Thermostatic shower mixer
Ref.: 67112 14 45 67



Termostática empotrada 2 vías
Built-in 2-way thermostatic mixer
Ref.: 64114 14 45 67



Termostática empotrada 3 vías
Built-in 3-way thermostatic
Ref.: 64111 14 45 67

Tau



Columna monomando extensible con kit
Single lever extensible column with kit
Ref.: CM65110 18



Columna termostática extensible con kit
Thermostatic extensible column with kit
Ref.: CT67110 18



Set columna con ducha, soporte y flexo
Column set with shower, holder and
flexible hose
Ref.: 1745 45



Ref.: CT67110 18



Ref.: 65134 29 45 66



Tau 2



Mezcla de formas.

Una colección con mucha personalidad que se sumerge en el contraste de las formas. El caño cilíndrico que proviene de la serie TAU convive con una maneta de formas totalmente rectas. Una fusión que aporta a esta colección un aire más actual.

Mixture of forms.

A collection with a lot of personality is immersed in the contrast of forms. The cylindrical spout that comes from the TAU series co-exists with a handle with totally straight lines. A fusion that contributes an air of modernity to the collection.

Acabado cromado. Cartucho 40.
Chromed finish. Cartridge 40.

Tau 2



Monomando de lavabo
Single lever wash-basin mixer
Ref.: 65135 29 45 66



Monomando de lavabo medio alto
Medium height single lever wash-basin mixer
Ref.: 65134 29 45 66



Monomando de lavabo alto
High single lever wash-basin mixer
Ref.: 65136 29 45 66



Monomando de lavabo empotrado caño 16 cm
Built-in wash-basin mixer 16 cm spout
Ref.: 65131 29 45 66



Monomando de lavabo empotrado caño 22 cm
Built-in wash-basin mixer 22 cm spout
Ref.: 65132 29 45 66



Monomando de bidé
Single lever bidet mixer
Ref.: 65145 29 45 66



Monomando de bidé con transmisión
Single lever bidet mixer with diverter
Ref.: 65142 29 45 66



Monomando de baño con kit *
Single lever bath mixer with kit *
Ref.: 65100 29 45 66



Monomando de ducha con kit *
Single lever shower mixer with kit *
Ref.: 65110 29 45 66



*** Kit incluido**
* Kit included

Mango de ducha C1 jet
C1 jet handshower
Ref.: 100197 45 00

Flexo H 1/2" - H 1/2" 1,70 m inoxidable
F 1/2" - F 1/2" Stainless steel flexible hose 1.70 m
Ref.: 100135 60 00

Soporte ducha cilíndrico
Cylindrical shower holder
Ref.: 100153 45

Tau 2



Monomando de ducha empotrado
Built-in single lever shower mixer
Ref.: 65115 29 45 66



Monomando empotrado con inversor 2 vías
2 way Built-in single lever mixer with diverter
Ref.: 65116 29 45 66

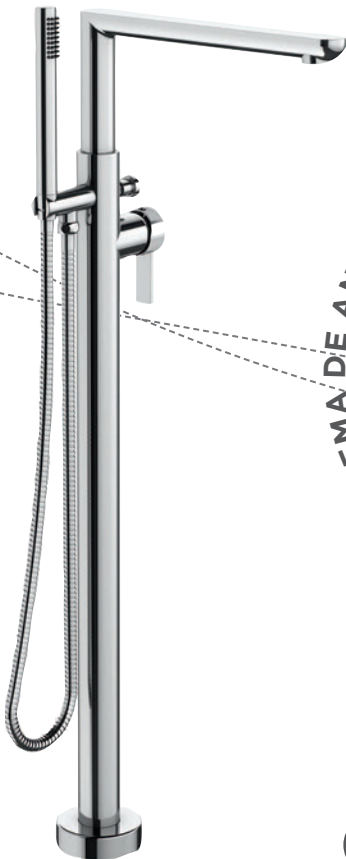

Monomando de pie para bañera Tau 2
Tau 2 Floor single lever mixer for bath
Ref.: 65119 29 45 66



NEW

Se crean 5 variantes de monomando para bañera exenta, y un juego de columnas equipables con la grifería a escoger. Todas las variantes poseen un sistema de regulación único, el cuál nos ayudará a instalarlo totalmente perpendicular y alineado perfectamente con la bañera.

5 variants of single-lever bath for exempt bathtub are created, and a set of columns that can be equipped with the taps to be selected. All the variants have a unique regulation system, which will help us to install it completely perpendicular and perfectly aligned with the bathtub.



Columna monomando extensible con kit
 Single lever extensible column with kit
 Ref.: CM65110 29

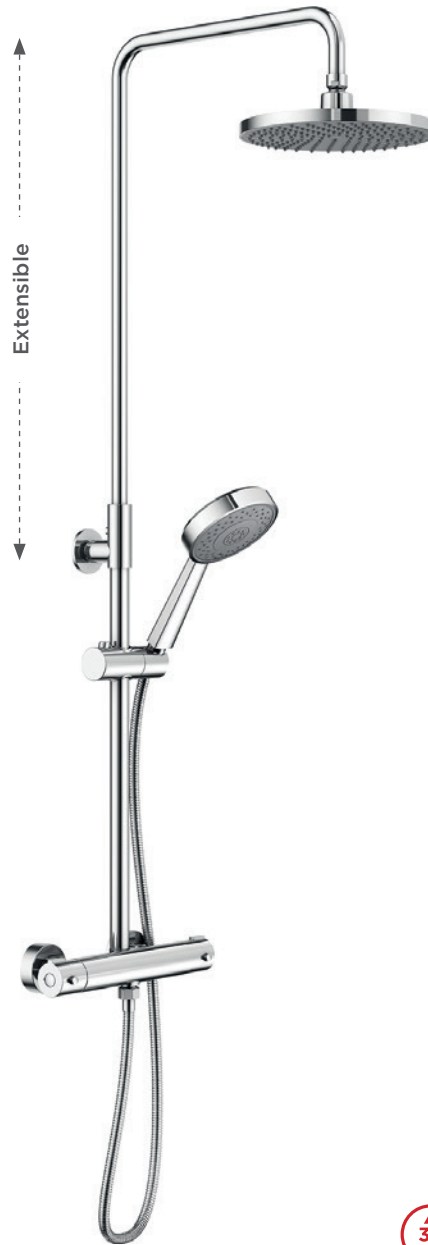

Columna termostática extensible con kit
 Thermostatic extensible column with kit
 Ref.: CT67110 18



Set columna con ducha, soporte y flexo
 Column set with shower, holder
 and flexible hose
 Ref.: 1745 45

Kenjo



Creada para sentir el placer del agua.

Diseño de gran belleza minimalista, con cuidadas formas rectas y una minuciosa atención a los detalles la convierten en una gama muy especial. Elegante y sobria, pero a la vez espectacular. La salida del agua es libre o tipo cascada que proporciona un chorro limpio y natural para disfrutar de momentos de intenso placer.

Acabado cromado. Cartucho 35.
Chromed finish. Cartridge 35.

Created to feel the pleasure of water.

A design with great minimalist beauty, careful straight lines, and a meticulous attention to detail make it a very special range. Elegant and simple, yet spectacular at the same time. The water outlet is free or waterfall-style and gives a clean and natural stream to enjoy the pleasures of water.





Ref.: 63137 26 45 66

Serie **Kenjo**

Kenjo



Monomando de lavabo
Single lever wash-basin mixer
Ref.: 63130 26 45 66



Monomando de lavabo medio alto
Medium height single lever wash-basin mixer
Ref.: 63134 26 45 66



Monomando de lavabo alto
High single lever wash-basin mixer
Ref.: 63136 26 45 66



Monomando de lavabo cascada
Waterfall single lever wash-basin mixer
Ref.: 63137 26 45 66



Monomando de lavabo cascada alto
High waterfall single lever wash-basin mixer
Ref.: 63138 26 45 66



Monomando de lavabo empotrado caño 16 cm
Built-in wash-basin mixer 16 cm spout
Ref.: 63131 26 45 66



Monomando de lavabo empotrado caño 22 cm
Built-in wash-basin mixer 22 cm spout
Ref.: 63132 26 45 66



Ref.: 63138 26 45 66

Kenjo



Monomando de bidé
Single lever bidet mixer
Ref.: 63140 26 45 66



Monomando de bidé con transmisión
Single lever bidet mixer with diverter
Ref.: 63142 26 45 66



Monomando de baño sin kit
Single lever bath mixer without kit
Ref.: 63100 26 45 67



Monomando de ducha sin kit
Single lever shower mixer without kit
Ref.: 63110 26 45 67



*** Kit de ducha recomendado:**
* Recommended shower kit:

Mango de ducha K3 jets
K3 jets handshower
Ref.: DXK3 45

Flexo H 1/2" - H 1/2" 1,70 m inoxidable
F 1/2" - F 1/2" Stainless steel flexible hose 1.70 m
Ref.: 100135 60 00

Soporte ducha Kenjo
Kenjo shower holder
Ref.: 100149 45



Consulte la ficha técnica de nuestros productos: Para encontrar toda la información técnica de cualquier producto, localice la referencia del artículo al final de este catálogo, o en nuestra web.

Consult data sheet of our products: Use the item reference to find all of the technical information on any of our products, at the end of this catalogue or our web.



Monomando de ducha empotrado

Built-in single lever shower mixer

Ref.: 63115 26 45 66



Monomando empotrado con inversor 2 vías

2 way Built-in single lever mixer with diverter

Ref.: 63116 26 45 66

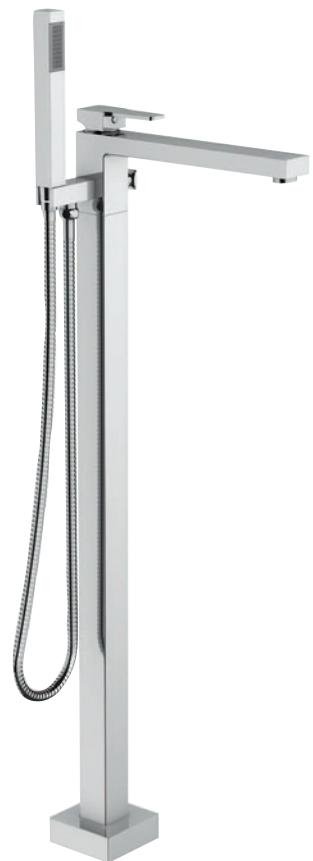

Monomando de pie para bañera Kenjo

Kenjo Floor single lever mixer for bath

Ref.: 63119 26 45 66

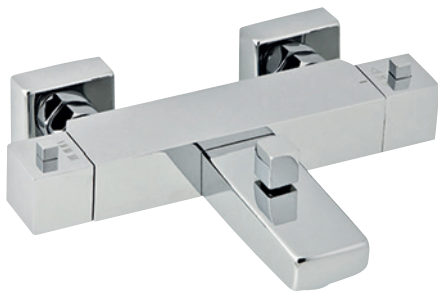

Termostática de baño sin kit

Thermostatic bath mixer without kit

Ref.: 67100 26 45 67

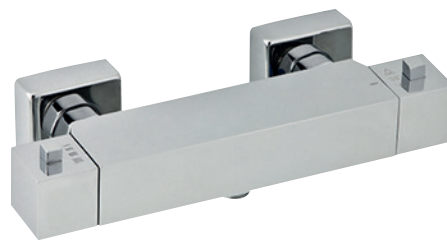

Termostática ducha sin kit

Thermostatic shower mixer without kit

Ref.: 67110 26 45 67



Ref.: 63119 26 45 66

Kenjo



Columna monomando extensible con kit
Single lever extensible column with kit
Ref.: CM63110 26



Columna termostática extensible con kit
Thermostatic extensible column with kit
Ref.: CT67110 26



Set columna con ducha, soporte y flexo
Extensible column set with shower, holder
and flexible hose
Ref.: 1746 45



Ref.: 60134 28 45 66



K8



La sencillez convertida en diseño..

A veces, lo más sencillo puede ser inolvidable. Como esta colección de formas discretas y sutiles, combinadas con delicadas líneas curvas y rectas que le confieren una personalidad única y la convierten en la elección ideal para el baño o la cocina.

Acabado cromado. Cartucho 40.
Chromed finish. Cartridge 40.

Simply design.

Sometimes the simplest things can be unforgettable. Like this collection of discreet, subtle forms, combined with delicate curved and straight lines which give it a unique personality and make it the ideal choice for the bathroom and the kitchen.

K8



Monomando de lavabo Plus
Medium height single lever wash-basin mixer
Ref.: 61130 28 45 66



Monomando de lavabo medio alto
Medium height single lever wash-basin mixer
Ref.: 60134 28 45 66



Monomando de lavabo alto
High single lever wash-basin mixer
Ref.: 60136 28 45 66



Monomando de lavabo
Single lever wash-basin mixer
Ref.: 60130 28 45 66



Monomando de lavabo centerset 4"
Single lever wash-basin mixer 4" centerset
Ref.: 60188 28 45 66



Monomando de bidé
Single lever bidet mixer
Ref.: 60140 28 45 66



Monomando de bidé con transmisión
Single lever bidet mixer with diverter
Ref.: 61142 28 45 66

La grifería GENE BRE está diseñada y fabricada según los estándares europeos de calidad, como la UNE-EN 19703 ofreciendo la funcionalidad, durabilidad y seguridad esperadas.

GENEBRE taps are designed and manufactured according to European quality standards, such as UNE-EN 19703, offering the expected functionality, durability and safety.

K8



Monomando de baño con kit
Single lever bath mixer with kit
Ref.: 60100 28 45 66



Monomando de ducha con kit
Single lever shower mixer with kit
Ref.: 60110 28 45 66



*** Kit incluido**
* Kit included

Mango de ducha E1 jet
E1 jet handshower
Ref.: 100175 45 00

Flexo H 1/2" - H 1/2" 1,70 m inoxidable
F 1/2" - F 1/2" Stainless steel flexible hose 1.70 m
Ref.: 100135 60 00

Soporte ducha
Shower holder
Ref.: 100152 45 00



Monomando de ducha empotrado
Built-in single lever shower mixer
Ref.: 61115 28 45 66



Monomando empotrado con inversor 2 vías
2 way Built-in single lever mixer with diverter
Ref.: 61116 28 45 66



Ref.: 60100 28 45 66



Ref.: 61130 22 45 66



Ge2



La grandeza de lo sencillo.

Sencillez y dinamismo, de formas naturales y enérgicas son los atributos que definen esta sugerente colección. Sus líneas curvas y, a la vez, inclinadas y ergonómicas, su resistencia y su gran fiabilidad le otorgan un aspecto inconfundible.

The greatness of the simple.

Simplicity and dynamism, with natural energetic forms, are the attributes that define this suggestive collection. Its curved and ergonomic lines, its resistance and great reliability give it a striking appearance.

Acabado cromado. Cartucho 40.
Chromed finish. Cartridge 40.

Ge2



Monomando de lavabo Plus
Single lever Plus wash-basin mixer
Ref.: 61130 22 45 66



Monomando de lavabo
Single lever wash-basin mixer
Ref.: 60130 22 45 66



Monomando de lavabo centerset 4"
Single lever wash-basin mixer 4" centerset
Ref.: 60188 22 45 66



Monomando de bidé
Single lever bidet mixer
Ref.: 60140 22 45 66



Monomando de bidé con transmisión
Single lever bidet mixer with diverter
Ref.: 61142 22 45 66



Monomando de baño con kit
Single lever bath mixer with kit
Ref.: 60100 22 45 66



Monomando de ducha con kit
Single lever shower mixer with kit
Ref.: 60110 22 45 66



*** Kit incluido**
* Kit included

Mango de ducha E1 jet
E1 jet handshower
Ref.: 100175 45 00

Flexo H 1/2" - H 1/2" 1,70 m inoxidable
F 1/2" - F 1/2" Stainless steel flexible hose 1.70 m
Ref.: 100135 60 00

Soporte ducha
Shower holder
Ref.: 100152 45 00



Monomando de ducha empotrado
Built-in single lever shower mixer
Ref.: 61115 22 45 66



Monomando empotrado con inversor 2 vías
2 way Built-in single lever mixer with diverter
Ref.: 61116 22 45 66

Ge2



Monomando empotrado con inversor 2 vías
2 way Built-in single lever mixer with diverter
Ref.: 61116 22 45 66

Rociador ducha con brazo
Wall shower arm and spray
Ref.: 1698 45 00

Caño mural baño fundido
Casted wall bath spout
Ref.: 1667 45

Monomando empotrado con inversor 2 vías
2 way Built-in single lever mixer with diverter
Ref.: 61116 22 45 66

Brazo pared redondo 35 cm
Round wall arm 35 cm
Ref.: B65113 18

Rociador redondo 22 cm
Round shower head Ø 22 cm
Ref.: R65112 18

Barra ducha redonda
Round shower bar
Ref.: 1638 45

Toma ducha mural redonda
Round wall connector
Ref.: 1680 04

Mango de ducha E2 jets
E2 jets handshower
Ref.: DXE2 45

Flexo H 1/2" - H 1/2" 1,70 m inoxidable
F 1/2" - F 1/2" Stainless steel flexible hose 1.70 m
Ref.: 100135 60 00

Grifo lavabo 1 agua cartucho 25
One-water wash-basin tap 25 cartridge
Ref.: 1002 04



Grifo lavabo mural 1 agua cartucho 25
One-water wall wash-basin tap 25 cartridge
Ref.: 1003 04



Grifo doble combinable 1/2"-3/4" y 1/2"
Double outlet tap 1/2"-3/4" and 1/2"
Ref.: 1023 04



**Grifo doble combinable a 1/2"- 3/4"
y Aireador**
Double outlet tap 1/2" - 3/4" and aerator
Ref.: 1024 04



Ge2



Grifo lavabo mural 1 agua cartucho 25
One-water wall wash-basin tap 25 cartridge
Ref.: 1006 04



Grifo lavabo 1 agua cartucho 25
One-water wash-basin tap 25 cartridge
Ref.: 1007 04



Grifo bide mural 1 agua
1 water wall bidet
Ref.: 60001 22 45 67



Flexo H 1/2" - H 1/2" 1,20 m inoxidable
F 1/2" - F 1/2" Stainless steel flexible hose 1.20 m
Ref.: 100141 45

Kit ducha sanitaria
Sanitary shower kit
Ref.: 100696 45

Consulte la ficha técnica de nuestros productos: Para encontrar toda la información técnica de cualquier producto, localice la referencia del artículo al final de este catálogo, o en nuestra web.

Consult data sheet of our products: Use the item reference to find all of the technical information on any of our products, at the end of this catalogue or our web.







Ref.: 68506 09 45 66

Serie **New Regent Classic**



New Regent Classic



Glamour vintage.

La serie New Regent Classic readapta el estilo más clásico, y a veces de elegancia barroca, a los baños y cocinas de hoy. Un excelente y refinado maridaje de calidad, glamour y estilo vintage que nos transporta a épocas lejanas. Disponibles en acabados cromo o bronce.

Vintage glamour.

The New Regent Classic series readapts a most classic style, almost baroque in elegance, to the bathrooms and kitchens of today. An excellent and refined blend of quality, glamour and vintage style that transports us to ancient times. Available in chrome and bronze finishes..

Montura 1/4 vuelta cierre cerámico.
Ceramic headwork quarter turn.

New Regent Classic



Monobloc de lavabo cromo
Chromed wash-basin mixer
Ref.: 68506 09 45 66



Monobloc de bidé cromo
Chromed bidet mixer
Ref.: 68516 09 45 66



Mezclador de baño cromo con kit *
Chromed bath mixer with kit *
Ref.: 68526 09 45 66



Mezclador de ducha cromo con kit *
Chromed shower mixer with kit *
Ref.: 68531 09 45 66



*** Kit incluido**
* Kit included

Mango de ducha New Regent cromo
New Regent chromed hand shower
Ref.: 100196 45 00

Flexo H 1/2" - H 1/2" 1,70 m inoxidable
F 1/2" - F 1/2" Stainless steel flexible hose 1.70 m
Ref.: 100135 60 00

Soporte ducha Clásico
Classic shower holder
Ref.: 1647 45



NEW

Pies para mezclador de bañera *
Floor support for bath mixer *
Ref.: 65120 45

*** Mezclador de baño no incluido**
* Bath mixer not included

Mezclador de baño cromo
Chromed bath mixer
Ref.: 68526 09 45 66



New Regent Classic



Monobloc de lavabo bronze
Bronze wash-basin mixer
Ref.: 68506 09 43 66



Monobloc bidet bronze
Bronze bidet mixer
Ref.: 68516 09 43 66



Mezclador de baño bronze con kit *
Bronze bath mixer with kit *
Ref.: 68526 09 43 66



Mezclador de ducha bronze con kit *
Bronze shower mixer with kit *
Ref.: 68531 09 43 66



*** Kit incluido**
* Kit included

Mango de ducha New Regent bronze
New Regent bronze hand shower
Ref.: 100196 43 00

Flexo H 1/2" - H 1/2" bronze 1,7 m
F 1/2" - F 1/2" bronze 1.7 m flexible hose
Ref.: 100135 43 00

Ref.: 1647 43



Llave de paso 1/2" Bronze
Bronze Stopcock 1/2"
Ref.: 68590 09 43 66



Brazo pared redondo 35cm Bronze
Bronze round wall arm 35cm
Ref.: B64113 43

Rociador redondo 20cm Bronze
Bronze round shower head 20cm
Ref.: R68113 43



Válvula universal click para bañera Bronze
Bronze Click pop-up waste for bath
Ref.: 100208 43



Válvula universal click Luxe con y sin rebosadero bronce
Bronze Luxe universal click pop-up waste with and without overflow
Ref.: 100211 43



Ref.: 68120 09 45 66

Serie **New Regent**



New Regent



Distinción y elegancia clásica.

De líneas curvas y volantes en cruz, esta colección está impregnada del estilo vintage del modelo New Regent Classic. Insinuando el pasado, sus líneas más sencillas y evocadoras la convierten en una bella selección de grifos que aportan un toque de romanticismo al ambiente.

Classic distinction and elegance.

With curved lines and cross handled wheels, this collection is permeated with full of vintage style from the New Regent Classic model. Insinuating the past, its simple and evocative lines makes it a beautiful selection of taps that add a touch of romanticism to the ambience.

Acabado cromado. Montura 1/4 vuelta cierre cerámico
Chromed finish. Ceramic headwork quarter turn

New Regent



Monobloc de lavabo
Wash-basin mixer
Ref.: 68505 09 45 66



Batería lavabo
Widespread wash-basin mixer
Ref.: 68510 09 45 66



Batería lavabo
Widespread wash-basin mixer
Ref.: 68120 09 45 66



Mezclador lavabo 4"
Wash-basin mixer 4"
Ref.: 68511 09 45 66



Grifo lavabo
Wash-basin tap
Ref.: 68500 09 45 66



Monobloc de bidé
Bidet mixer
Ref.: 68515 09 45 66



Grifo bidé
Bidet tap
Ref.: 68520 09 45 66



Batería de bidé con transmisión
Widespread bidet mixed with transmission
Ref.: 68142 09 45 66



Mezclador de baño con kit *
Bath mixer with kit *
Ref.: 68525 09 45 66



Mezclador de ducha con kit *
Shower mixer with kit *
Ref.: 68530 09 45 66



*** Kit incluido**
* Kit included

Mango de ducha E1 jet
E1 jet handshower
Ref.: 100175 45 00

Flexo H 1/2" - H 1/2" 1,70 m inoxidable
F 1/2" - F 1/2" Stainless steel flexible hose 1.70 m
Ref.: 100135 60 00

Soporte ducha
Shower holder
Ref.: 100152 45 00

New Regent



Grupo de lavabo empotrado
Built-in wash-basin mixer
Ref.: 68131 09 45 66



Grupo ducha empotrado 8"
Built-in 8" shower mixer
Ref.: 68535 09 45 66



Grupo baño empotrado 8" con inversor
Built-in 8" bath mixer with diverter
Ref.: 68527 09 45 66



Llave de paso 1/2"
Stopcock 1/2"
Ref.: 68590 09 45 66



Grifo de bidé con teleducha
Bidet tap with shower
Ref.: 68001 09 45 66

Ref.: 68131 09 45 66





Ref.: 68130 11 45 66

Gamma



Discreción intencionada.

Sencilla y discreta. Ideal para aquellos espacios que buscan funcionalidad. De estilo bimando y características clásicas, los grifos de esta serie ofrecen un excelente equilibrio entre su diseño sereno y la alta calidad.

Intentional discretion.

Simple and discreet. Ideal for those spaces seeking functionality. With dual handles and classic features, the taps in this series offer an excellent balance between their serene design and high quality.

Acabado cromado. Montura convencional.
Chromed finish. Conventional headwork.

Gamma



Monobloc de lavabo
Wash-basin mixer
Ref.: 68130 11 45 66



Batería de lavabo
Widespread wash-basin mixer
Ref.: 68120 11 45 66



Mezclador lavabo 4''
Wash-basin mixer 4''
Ref.: 68122 11 45 66



Grifo de lavabo
Wash-basin tap
Ref.: 68180 11 45 66

La grifería GENE BRE está diseñada y fabricada según los estándares europeos de calidad, como la UNE-EN 19703 ofreciendo la funcionalidad, durabilidad y seguridad esperadas.

GENEBRE taps are designed and manufactured according to European quality standards, such as UNE-EN 19703, offering the expected functionality, durability and safety.



Monobloc de bidé
Bidet mixer
Ref.: 68140 11 45 66



Grifo bidé
Bidet tap
Ref.: 68160 11 45 66



Batería de bidé con transmisión
Widespread bidet mixer with transmission
Ref.: 68142 11 45 66



Mezclador de baño con kit *
Bath mixer with kit *
Ref.: 68100 11 45 66



Mezclador de ducha con kit *
Shower mixer with kit *
Ref.: 68110 11 45 66



*** Kit incluido**
* Kit included

Mango de ducha E1 jet
E1 jet handshower
Ref.: 100175 45 00

Flexo H 1/2" - H 1/2" 1,70 m inoxidable
F 1/2" - F 1/2" Stainless steel flexible hose 1.70 m
Ref.: 100135 60 00

Soporte ducha
Shower holder
Ref.: 100152 45 00

Gamma



Grupo de lavabo empotrado

Built-in wash-basin

Ref.: 68131 11 45 66



Grupo ducha empotrado 8"

Built-in 8" shower mixer

Ref.: 68115 11 45 66



Grupo baño empotrado 8" con inversor

Built-in 8" bath mixer with diverter

Ref.: 68116 11 45 66



Llave de paso 1/2"

Stopcock 1/2"

Ref.: 68170 11 45 66



Grifo de bidé con teleducha

Bidet tap with shower

Ref.: 68001 11 45 66

Consulte la ficha técnica de nuestros productos: Para encontrar toda la información técnica de cualquier producto, localice la referencia del artículo al final de este catálogo, o en nuestra web.

Consult data sheet of our products: Use the item reference to find all of the technical information on any of our products, at the end of this catalogue or our web.







Ref.: 68125 12 45 66



Ixo



Infinitas posibilidades.

Fusión entre elegancia clásica y minimalismo. Los volantes del modelo Ixo de formas geométricas y muy estilizadas son ideales para conjuntar con las múltiples posibilidades de caños que ofrece la colección. Un diseño actual y hermoso que consigue un ambiente muy especial.

Infinite possibilities.

A fusion of classic elegance and minimalism. The handles of the Ixo model with geometric stylised forms are ideal to match with the multiple possibilities of spouts that the collection offers. A current, attractive design that achieves a very special ambience.

Acabado cromado. Montura 1/4 vuelta cierre cerámico
Chromed finish. Ceramic headwork quarter turn

Ixo



Batería de lavabo caño recto
Widespread wash-basin mixer
with straight pipe spout
Ref.: 68120 12 45 66



Batería de lavabo caño cisne
Widespread wash-basin mixer
with swan pipe spout
Ref.: 68124 12 45 66



Batería de lavabo caño inclinado
Widespread wash-basin mixer
with sloping pipe spout
Ref.: 68125 12 45 66



Grupo de lavabo empotrado caño 16 cm
Built-in wash-basin mixer
with 16 cm pipe spout
Ref.: 68131 12 45 66



Grupo de lavabo empotrado caño 22 cm
Built-in wash-basin mixer
with 22 cm pipe spout
Ref.: 68132 12 45 66



Las series Kalo, Kross e Ixo nacen de la combinación de diferentes componentes: cuerpos, caños y volantes.
 Busque la combinación que mejor se adapte a su baño. Puede pedirla utilizando la referencia del catálogo (conjunto) o bien por referencia de cada uno de los componentes (ver información técnica en la página 244).
 The series Kalo, Kross and Ixo are born from the combination of different components: bodies, pipes and handles.
 Look for the combination that best suits your bathroom. You can order it using the set reference or by components reference (see technical information on page 244).



Grupo ducha empotrado 8"
 Built-in 8" shower mixer
 Ref.: 68115 12 45 66



Grupo ducha empotrado 8" con inversor
 Built-in 8" shower mixer with diverter
 Ref.: 68116 12 45 66



Inversor cerámico 3 vías empotrado placa redonda
 Built-in 3 way ceramic diverter with round plate
 Ref.: 63114 30 45 66



Batería de baño con inversor
 Widespread bath mixer with diverter
 Ref.: 68113 12 45 66



Batería de bidé con transmisión
 Widespread bidet mixer with transmission
 Ref.: 68142 12 45 66



Llave de paso 1/2"
 Stopcock 1/2"
 Ref.: 68170 12 45 66



Ref.: 68124 08 45 66



Kross



En la variedad está el gusto.

Los volantes de la serie Kross están diseñados para ser los protagonistas de los baños más elegantes. Y la posibilidad de combinarse con diferentes tipos de caños le permite múltiples opciones para adaptarse a cada estilo de baño.

A taste for diversity.

The handle in the Kross series are designed to be the main focus of the most elegant bathrooms. They offer the possibility to combine with different types of spouts that allow for multiple options to adapt to each style of bathroom.

Acabado cromado. Montura 1/4 vuelta cierre cerámico
Chromed finish. Ceramic headwork quarter turn

Kross



Batería de lavabo caño recto
Widespread wash-basin mixer
with straight pipe spout
Ref.: 68120 08 45 66



Batería de lavabo caño cisne
Widespread wash-basin mixer
with swan pipe spout
Ref.: 68124 08 45 66



Batería de lavabo caño inclinado
Widespread wash-basin mixer
with sloping pipe spout
Ref.: 68125 08 45 66



Grupo de lavabo empotrado caño 16 cm
Built-in wash-basin mixer
with 16 cm pipe spout
Ref.: 68131 08 45 66



Grupo de lavabo empotrado caño 22 cm
Built-in wash-basin mixer
with 22cm pipe spout
Ref.: 68132 08 45 66

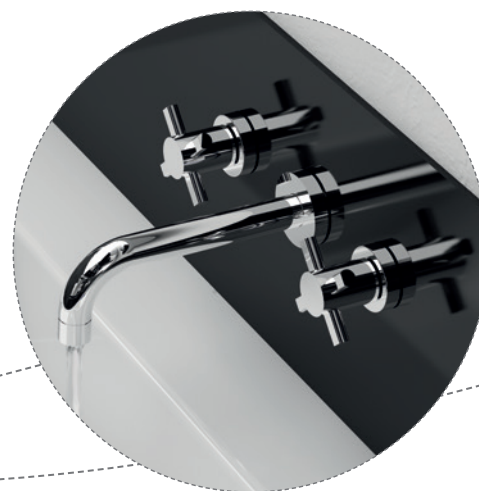

Las series Kalo, Kross e Ixo nacen de la combinación de diferentes componentes: cuerpos, caños y volantes.
 Busque la combinación que mejor se adapte a su baño. Puede pedirla utilizando la referencia del catálogo (conjunto) o bien por referencia de cada uno de los componentes (ver información técnica en la página 242).
 The series Kalo, Kross and Ixo are born from the combination of different components: bodies, pipes and handles.
 Look for the combination that best suits your bathroom. You can order it using the set reference or by components reference (see technical information on page 242).



Grupo ducha empotrado 8"
 Built-in 8" shower mixer
 Ref.: 68115 08 45 66



Grupo ducha empotrado 8" con inversor
 Built-in 8" bath mixer with diverter
 Ref.: 68116 08 45 66



Inversor cerámico 3 vías empotrado placa redonda
 Built-in 3 way ceramic diverter with round plate
 Ref.: 63114 30 45 66



Batería de baño con inversor
 Widespread bath mixer with diverter
 Ref.: 68113 08 45 66



Batería de bidé con transmisión
 Widespread bidet mixer with transmission
 Ref.: 68142 08 45 66



Llave de paso 1/2"
 Stopcock 1/2"
 Ref.: 68170 08 45 66

Kalo



Diseño modular para todos los estilos.

Genebre ha diseñado tres series de grifería bimanual que combinan de forma perfecta y armoniosa los diferentes caños y volantes: Kalo, Kross e Ixo. Una propuesta muy versátil de formas sencillas y elegantes que permite múltiples combinaciones, únicas y personales.

Modular design for all styles.

Genebre has designed three series of dual-handle taps that perfectly and harmoniously combine these different spouts and handles: Kalo, Kross and Ixo. A versatile design with simple elegant forms which allow for multiple, personal and unique combinations.

Acabado cromado. Montura 1/4 vuelta cierre cerámico.
Ceramic headwork quarter turn.

Serie **Kalo**





Ref.: 68120 07 45 66

Serie **Kalo**

Kalo



Batería de lavabo caño recto
Widespread wash-basin mixer
with straight pipe spout
Ref.: 68120 07 45 66



Batería de lavabo caño cisne
Widespread wash-basin mixer
with swan pipe spout
Ref.: 68124 07 45 66



Batería de lavabo caño inclinado
Widespread wash-basin mixer
with sloping pipe spout
Ref.: 68125 07 45 66



Grupo de lavabo empotrado caño 16 cm
Built-in wash-basin mixer
with 16 cm pipe spout
Ref.: 68131 07 45 66



Grupo de lavabo empotrado caño 22 cm
Built-in wash-basin
with 22 cm pipe spout
Ref.: 68132 07 45 66

Las series Kalo, Kross e Ixo nacen de la combinación de diferentes componentes: cuerpos, caños y volantes.
 Busque la combinación que mejor se adapte a su baño. Puede pedirla utilizando la referencia del catálogo (conjunto) o bien por referencia de cada uno de los componentes (ver información técnica en la página 241).
 The series Kalo, Kross and Ixo are born from the combination of different components: bodies, pipes and handles.
 Look for the combination that best suits your bathroom. You can order it using the set reference or by components reference (see technical information on page 241).

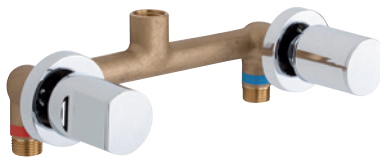

Grupo ducha empotrado 8"
 Built-in 8" shower mixer
 Ref.: 68115 07 45 66



Grupo baño empotrado 8" con inversor
 Built-in 8" bath mixer with diverter
 Ref.: 68116 07 45 66



Inversor cerámico 3 vías empotrado placa redonda
 Built-in 3 way ceramic diverter with round plate
 Ref.: 63114 30 45 66



Batería de baño con inversor
 Widespread bath mixer with diverter
 Ref.: 68113 07 45 66



Batería de bidé con transmisión
 Widespread bidet mixer with transmission
 Ref.: 68142 07 45 66



Llave de paso 1/2"
 Stopcock 1/2"
 Ref.: 68170 07 45 66

Style shower



Duchas con estilo.

Para que a la ducha no le falte de nada. Disponemos de una amplia gama de mangos de duchas, accesorios y complementos ideales para cada modelo. Una colección que convierte a cada pieza en una creación inteligente y totalmente flexible para un entorno de bienestar.

Showers with style.

For the shower that has everything. We have a wide range of jet handshowers, accessories and complements ideal for each model. A collection that turns each piece in to an intelligent creation, totally flexible for an environment of well being.





Style shower

Style shower



NEW

Inversor cerámico 3 vías empotrado con placa cuadrada
Built-in 3-way ceramic diverter with square plate
Ref.: 65114 30 45 66

Monomando de ducha empotrado
Built-in single lever shower mixer
Ref.: 65115 18 45 66

Rociador doble función cascada-lluvia
Shower head double function waterfall-rain
Ref.: 1643 45

Toma ducha mural redonda
Round wall connector
Ref.: 1680 04

Conjunto Tau, barra, flexo y ducha 5 jets
Tau set, bar, hose and 5 jets handshower
Ref.: 1748 45

Monomando empotrado con inversor cerámico 3 vías
Built-in single lever mixer with 3-way ceramic diverter
Ref.: 64118 32 45 66

Rociador doble función cascada-lluvia
Shower head double function waterfall-rain
Ref.: 1643 45

Soporte de ducha cilíndrico con toma 1/2"
Cylindrical shower holder with 1/2" connector
Ref.: 1634 04

Flexo extensible 1,70 - 2,25 m inoxidable doble grapaje
Extensible stainless steel flexible hose 1,70 to 2,25 m double lock
Ref.: 100137 60 00

Mango de ducha T3 jets
T3 jets handshower
Ref.: DXT3 45

Grupo ducha empotrado 8" con inversor
Built-in 8" shower mixer with diverter
Ref.: 68116 12 45 66

Inversor cerámico 3 vías empotrado placa redonda
Built-in 3 way ceramic diverter with round plate
Ref.: 63114 30 45 66

Rociador doble función cascada-lluvia
Shower head double function waterfall-rain
Ref.: 1643 45

Soporte de ducha orientable cilíndrico con toma 1/2"
Orientable cylindrical shower holder with 1/2" connector
Ref.: 1633 04

Flexo extensible H 1/2" - H 1/2" 1,70 - 2,25 m inoxidable
F 1/2" - F 1/2" Extensible stainless steel flexible hose 1.70 to 2.25 m
Ref.: 100137 60 00

Mango de ducha T3 jets
T3 jets handshower
Ref.: DXT3 45

Caño mural baño cilíndrico
Round wall bath spout
Ref.: 1668 45



**Ejemplos de combinaciones*
para todos los espacios y necesidades.**

**Examples of combinations* for all kind
of spaces and needs.**

* En cada combinación hay un conjunto de referencias que han de ser solicitadas para obtener su conjunto.

* In each combination there is a set of references that have to be requested to obtain their set.

Style shower



NEW

Monomando empotrado con inversor cerámico 2 vías
Built-in single lever mixer with 2-way ceramic diverter
Ref.: 64117 32 45 66

Brazo pared redondo 35 cm
Round wall arm 35 cm
Ref.: B65113 18

Rociador D22 ovalado
Oval D22 shower sprayer
Ref.: R63112 08

Soporte de ducha cilíndrico con toma 1/2"
Cylindrical shower holder with 1/2" connector
Ref.: 1634 04

Flexo extensible 1,70 - 2,25 m inoxidable doble grapaje
Extensible stainless steel flexible hose 1,70 to 2,25 m double lock
Ref.: 100137 60 00

Mango de ducha T3 jets
T3 jets handshower
Ref.: DXT3 45

Monomando empotrado con inversor cerámico 3 vías
Built-in single lever mixer with 3-way ceramic diverter
Ref.: 65118 18 45 66

Brazo pared redondo 35 cm
Round wall arm 35 cm
Ref.: B65113 18

Rociador redondo 22 cm
Round shower head Ø 22 cm
Ref.: R65112 18

Toma ducha mural redonda
Round wall connector
Ref.: 1680 04

Conjunto Tau, barra, flexo y ducha 5 jets
Tau set, bar, hose and 5 jets handshower
Ref.: 1748 45

Caño mural baño cilíndrico
Round wall bath spout
Ref.: 1668 45

Monomando empotrado con inversor 2 vías
2 way Built-in single lever mixer with diverter
Ref.: 64116 16 45 66

Brazo pared redondo 35 cm
Round wall arm 35 cm
Ref.: B65113 18

Rociador redondo 22 cm
Round shower head Ø 22 cm
Ref.: R65112 18

Caño mural baño cilíndrico
Round wall bath spout
Ref.: 1668 45



Monomando empotrado con inversor 2 vías
2 way Built-in single lever mixer with diverter
Ref.: 63116 26 45 66

Brazo pared cuadrado 35 cm
Square wall arm 35 cm
Ref.: B63113 26

Rociador cuadrado 22 cm
Square shower head 22 cm
Ref.: R63112 26

Caño mural baño cuadrado
Square wall bath spout
Ref.: 1674 45



Style shower



Monomando de baño sin kit
Single lever bath mixer without kit
Ref.: 63100 26 45 67

Set columna con ducha, soporte y flexo
Column set with shower, holder and flexible hose
Ref.: 1746 45



Termostática ducha sin kit
Thermostatic shower mixer without kit
Ref.: 67110 26 45 67

Set columna con ducha, soporte y flexo
Column set with shower, holder and flexible hose
Ref.: 1746 45

Consulte la ficha técnica de nuestros productos: Para encontrar toda la información técnica de cualquier producto, localice la referencia del artículo al final de este catálogo, o en nuestra web.

Consult data sheet of our products: Use the item reference to find all of the technical information on any of our products, at the end of this catalogue or our web.





Style shower

Style shower



Grupo ducha empotrado 8"

Built-in 8" shower mixer

Ref.: 68115 08 45 66

Toma ducha mural redonda

Round wall connector

Ref.: 1680 04

Set columna con ducha, soporte y flexo

Column set with shower, holder and flexible hose

Ref.: 1745 45



Monomando de ducha empotrado

Built-in single lever shower mixer

Ref.: 64115 16 45 66

Toma ducha mural redonda

Round wall connector

Ref.: 1680 04

Set columna con ducha, soporte y flexo

Column set with shower, holder and flexible hose

Ref.: 1745 45



Monomando empotrado con inversor cerámico 3 vías

Built-in single handle mixer with 3-way ceramic diverter

Ref.: 64118 04 45 66

Brazo a techo redondo 15 cm

Round roof arm 15 cm

Ref.: 1671 45

Rociador redondo 22 cm

Round shower head Ø 22 cm

Ref.: R65112 18

Toma ducha mural redonda

Round wall connector

Ref.: 1680 04

Barra ducha metálica

Metallic shower bar

Ref.: 1639 45

Flexo H 1/2" - H 1/2" 1,70 m. PVC antirrotura

F 1/2" - F 1/2" PVC flexible hose 1.70 m anti-breaking

Ref.: 100140 30

Mango de ducha T3 jets

T3 jets handshower

Ref.: DXT3 45

Caño mural baño cilíndrico

Round wall bath spout

Ref.: 1668 45



Monomando empotrado con inversor 2 vías

2 way Built-in single lever mixer with diverter

Ref.: 63116 26 45 66

Brazo a techo cuadrado 15 cm

Square roof arm 15 cm

Ref.: 1672 45

Rociador cuadrado 22 cm

Square shower head 22 cm

Ref.: R63112 26

Toma ducha mural cuadrada

Square wall connector

Ref.: 1679 04

Conjunto Kenjo, barra, flexo y ducha 3 jets

Kenjo set, bar, flexible hose and 3 jets handshower

Ref.: 1747 45

Monomando empotrado con inversor cerámico 2 vías

Built-in single lever mixer with 2 way ceramic diverter

Ref.: 62117 31 45 66

Brazo a techo redondo 15 cm

Round roof arm 15 cm

Ref.: 1671 45

Rociador ovalado 22 cm

Oval shower head 22 cm

Ref.: R65112 08

Soporte de ducha orientable cilíndrico con toma 1/2"

Orientable cylindrical shower holder with 1/2" connector

Ref.: 1633 04

Flexo extensible H 1/2" - H 1/2" 1,70 - 2,25 m inoxidable

F 1/2" - F 1/2" Extensible stainless steel flexible hose 1.70 to 2.25 m

Ref.: 100137 60 00

Mango de ducha O3 jets

O3 jets handshower

Ref.: DXO3 45

A modern kitchen scene featuring a dark wood countertop, a marble table, and a stool. The background is a light-colored wall with vertical lines. A single pendant light hangs from the ceiling. The text "Cocinas" is in large black font, and "Kitchen" is in a smaller teal font below it. Dotted lines are drawn across the middle of the image.

Cocinas

Kitchen



Cocinas para todos los gustos

Porque sabemos que en la cocina hay tantas maneras de preparar una misma receta como cocineros dispuestos a interpretarla, te presentamos nuestra amplia gama de fregaderas de cocina.

Tú eliges. Higiénicas. Cómodas. Móviles. Con muelle. Plegables. Osmóticas. Blancas. Negras. Cromadas. Inox...

Seguro que aquí encontrarás una fregadera dispuesta a adaptarse a tus necesidades.

Imagina la mejor versión de tu cocina, y hazla realidad con Genebre.

Kitchens for every taste

Because in the kitchen there are as many ways to prepare the same recipe as there are cooks willing to interpret it, we present our wide range of kitchen sinks.

You choose. Hygienic. Comfortable. Mobiles. With spring. Foldable. Osmotics. White. Black. Chrome. Inox ...

Surely here you will find a sink ready to adapt to your needs.

Imagine the best version of your kitchen, and make it a reality with Genebre.



Fregaderas para encimeras
Countertop sinks



Fregaderas para filtrado y osmosis
Sinks for filtration and osmosis



Fregaderas extraíbles
Removable sinks



Fregaderas con muelle
Sinks with spring



Fregaderas murales
Wall-mounted sinks



Fregaderas abatibles
Folding sinks



Fregaderas selección inox
Stainless steel selection sinks



Fregaderas Classic
Classic sinks



Fregaderas de 1 agua
One-water sinks

Cocinas / Kitchen

Fregaderas para encimeras Countertop sink mixers

Cartucho \varnothing 40 Cartridge



Monomando de fregadera Koral
Koral Single lever sink mixer
Ref.: 64201 32 45 66



Monomando de fregadera Klip
Klip Single lever sink mixer
Ref.: 64201 16 45 66



Monomando de fregadera apertura frío Kelogic
Kelogic Single lever sink mixer cold start
Ref.: 64201 04 45 66



Monomando de fregadera cartucho 40 Tau
Tau Single lever sink mixer 40 cartridge
Ref.: 65214 18 45 66



Monomando de fregadera cartucho 40 Tau
Tau Single lever sink mixer 40 cartridge
Ref.: 65204 18 45 66



Monomando de fregadera cartucho 40 Tau
Tau Single lever sink mixer 40 cartridge
Ref.: 65203 18 45 66

Fregaderas para encimeras Countertop sink mixers

Cartucho $\varnothing 40$ Cartridge



Monomando de fregadera caño fundido K8
K8 Single lever sink mixer casted spout
Ref.: 61201 28 45 66



Monomando de fregadera caño conformado K8
K8 Single-lever sink mixer tube spout
Ref.: 61203 28 45 66



Monomando de fregadera caño fundido K8
K8 Single lever sink mixer casted spout
Ref.: 61210 28 45 66



Monomando de fregadera caño conformado K8
K8 Single-lever sink mixer tube spout
Ref.: 61204 28 45 66



Monomando de fregadera K8
K8 Single lever sink mixer
Ref.: 61200 28 45 66

Cocinas / Kitchen

Fregaderas para encimeras Countertop sink mixers

Cartucho \varnothing 35 Cartridge



Monomando de fregadera Oslo
Oslo Single lever sink mixer
Ref.: 65200 19 45 66



Monomando de fregadera apertura en frío Oslo
Oslo Single lever sink mixer cold start
Ref.: 65203 19 45 66



Monomando de fregadera cartucho 35 apertura en frío Tau
Tau Single lever sink mixer 35 cartridge cold start
Ref.: FRT65402



Monomando de fregadera cartucho 35 apertura en frío Tau
Tau Single lever sink mixer 35 cartridge cold start
Ref.: 65404 18 45 66



Ref.: 65404 18 45 66

Fregaderas para encimeras Countertop sink mixers

Cartucho \varnothing 25 Cartridge



Monomando de fregadera cartucho 25 apertura en frío Tau Black

Tau Black Single lever sink mixer 25 cartridge cold start

Ref.: 65403 18 41 66



Monomando de fregadera cartucho 25 apertura en frío Tau Blanca

Tau White Single lever sink mixer 25 cartridge cold start

Ref.: 65403 18 40 66



Monomando de fregadera Tau acabado Acero Inoxidable cartucho 25 apertura en frío

Tau Stainless steel finish single lever sink mixer 25 cartridge cold start

Ref.: 65403 18 44 66



Ref.: 65403 18 41 66



Monomando de fregadera cartucho 25 apertura en frío Tau

Tau Single lever sink mixer 25 cartridge cold start

Ref.: 65403 18 45 66

Cocinas / Kitchen

Fregaderas para encimeras Countertop sink mixers

Cartucho $\varnothing 25$ Cartridge



Monomando de fregadera cartucho 25 apertura en frío Tau

Tau Single lever sink mixer 25 cartridge
cold start

Ref.: 65219 18 45 66

Monomando de fregadera cartucho 25 apertura en frío Tau

Tau Single lever sink mixer 25 cartridge
cold start

Ref.: 65215 18 45 66



Ref.: 65219 18 45 66

Fregaderas para encimeras Countertop sink mixers

Cartucho $\varnothing 25$ Cartridge



Monomando de fregadera cartucho 25 apertura en frío Tau

Tau Single lever sink mixer 25 cartridge cold start
Ref.: FRT65401



Monomando de fregadera cartucho 25 Kenjo

Kenjo Single lever sink mixer 25 cartridge
Ref.: FRK63400



Monomando de fregadera cartucho 25 Kenjo

Kenjo Single lever sink mixer 25 cartridge
Ref.: FRK63401



Monomando mesada 8" cartucho 35

8" widespread single lever sink mixer 35 cartridge
Ref.: 60198 05 45 66



Monomando mesada 16cm cartucho 35

16cm widespread single lever sink mixer 35 cartridge
Ref.: 60199 05 45 66

La grifería GENE BRE está diseñada y fabricada según los estándares europeos de calidad, como la UNE-EN 19703 ofreciendo la funcionalidad, durabilidad y seguridad esperadas.

GENEBRE taps are designed and manufactured according to European quality standards, such as UNE-EN 19703, offering the expected functionality, durability and safety.

Tu manantial de agua pura y sana

Your own source of pure and healthy water

El nuevo sistema de ultrafiltración GENE BRE purifica el agua conservando todos los minerales y propiedades beneficiosas para la salud.

The new GENE BRE ultrafiltration anti system purifies water conserving all the minerals and properties that are beneficial to your health.

En el proceso de ultrafiltración participan un primer cartucho compuesto de carbón activo de clorador, para el filtrado y retención de olores y sabores, cloro libre, compuestos orgánicos, trihalometanos y DQO. El cartucho verde es de ultra filtración anti bacteriológico con una efectividad superior al 99% la eliminación de E. Coli, bacterias coliformes y aerobios totales.

The ultrafiltration process involves a first cartridge composed of dechlorinating active carbon, to filter and retain odours and flavours, free chlorine, organic compounds, trihalomethanes and COD. The green cartridge offers anti-bacteriological ultrafiltration, which is more than 99% effective at eliminating E. coli, coliform and total aerobic bacteria.

Grifo elegante y funcional 3 vías
Elegant and functional 3-way tap

Salida de agua corriente
Running water outlet

Salida de agua filtrada
Filtered water outlet

Carbón activo de clorador
Dechlorinator activated carbon

El filtro azul elimina olores y malos sabores dejando el agua pura.

The blue filter eliminates odours and bad tastes leaving pure water.

Filtración anti bacteriológica
Anti-bacteriological filtration

El cartucho verde realiza una ultrafiltración anti bacteriológica con una efectividad superior al 99%, para un agua sana.

The green cartridge performs anti-bacteriological ultrafiltration, with more than 99% effectiveness, for healthy water.



Fregaderas para filtrado

Sink mixers for filtration

Cartucho **Ø35** Cartridge



Monomando de fregadera
Acero Inoxidable 3 vías
 Stainless steel single lever
 3-way sink mixer
 Ref.: 65703 18 60 66

Cartucho **Ø40** Cartridge



Monomando de fregadera 3 vías
apertura en frío
 Single lever 3-way sink mixer cold start
 Ref.: 65702 18 45 66

Montura cerámica Ceramic frame



Grifo de 1 vía
 One way tap
 Ref.: 65700 18 45 66

Accesorios Accessories



Kit de clorador
 Dechlorinator kit
 Ref.: FT00



Kit ultrafiltración
 Ultrafiltration kit
 Ref.: FT01



Cocinas / Kitchen

Fregaderas extraíbles Pull out sink mixers

Cartucho Ø25 Cartridge



Monomando de fregadera caño extraíble Tau Negra
Tau Black single-lever sink mixer with pull-out spout
Ref.: FRV61208 41



Monomando de fregadera caño extraíble acabado Acero Inoxidable Tau
Tau Stainless steel finish single-lever sink mixer with pull-out spout
Ref.: FRV61208 44



Monomando de fregadera caño extraíble Tau
Tau Single-lever sink mixer with pull-out spout
Ref.: FRV61208 45



Fregaderas extraíbles Pull out sink mixers

Cartucho $\varnothing 35$ Cartridge



Monomando de fregadera caño extraíble Tau
Tau Single-lever sink mixer with pull-out spout
Ref.: FRV61207 41



Monomando de fregadera caño extraíble Tau
Tau Single-lever sink mixer with pull-out spout
Ref.: FRV61207 40



Monomando de fregadera caño extraíble acabado Acero Inoxidable Tau
Tau Stainless steel finish single-lever sink mixer with pull-out spout
Ref.: FRV61207 44



Monomando de fregadera caño extraíble Tau
Tau Single-lever sink mixer with pull-out spout
Ref.: FRV61206



Cocinas / Kitchen

Fregaderas extraíbles Pull out sink mixers

Cartucho Ø40 Cartridge



Monomando de fregadera ducha extraíble Tau
Tau Single lever sink mixer with pull-out spray
Ref.: 65205 18 45 66



Monomando de fregadera caño extraíble Tau
Tau Single lever sink mixer with pull-out spout
Ref.: 65206 18 45 66



Monomando de fregadera ducha extraíble Tau
Tau Single lever sink mixer with pull-out spray
Ref.: FRV61205



Ref.: 64206 16 45 66

Fregaderas extraíbles Pull out sink mixers

Cartucho **Ø40** Cartridge



Monomando de fregadera ducha extraíble Koral
Koral Single lever sink mixer with pull-out spray
Ref.: 64206 32 45 66



Monomando de fregadera ducha extraíble Klip
Klip Single lever sink mixer with pull-out spray
Ref.: 64206 16 45 66



Monomando de fregadera ducha extraíble K8
K8 Single lever sink mixer with pull-out spray
Ref.: 61205 28 45 66



Monomando de fregadera ducha extraíble K8
K8 Single-lever sink mixer with pull-out spray
Ref.: 61206 28 45 66

Cocinas / Kitchen

Fregaderas con muelle Sink mixers with spring

Cartucho $\varnothing 35$ Cartridge



Monomando de fregadera Acero Inoxidable con muelle

Stainless steel single lever sink mixer with spring

Ref.: 65211 18 60 66



Monomando de fregadera Acero Inoxidable con muelle y ducha extraíble

Stainless steel single lever sink mixer with spring and pull-out sprayer

Ref.: 65207 18 60 66



Monomando de fregadera con muelle

Single lever sink mixer with spring

Ref.: 65211 18 45 66



Monomando de fregadera con muelle y caño

Single lever sink mixer with spring and spout

Ref.: 65212 18 45 66





Ref.: 65212 18 45 66

Cocinas / Kitchen

Fregaderas murales Wall-mounted sink mixers

Cartucho $\varnothing 40$ Cartridge



Monomando de fregadera mural Koral
Koral Wall single lever sink mixer
Ref.: 64192 32 45 66



Monomando de fregadera mural Klip
Klip Wall single lever sink mixer
Ref.: 64192 16 45 66



Monomando de fregadera mural 15 cm Tau
Tau Wall single lever sink mixer 15 cm
Ref.: 65192 18 45 66

Cartucho $\varnothing 35$ Cartridge



Monomando de fregadera mural 15 cm Oslo
Oslo Wall single lever sink mixer 15 cm
Ref.: 65192 19 45 66



Fregaderas murales Wall-mounted sink mixers

Cartucho $\varnothing 40$ Cartridge



Monomando de fregadera mural 15 cm caño corto K8

K8 Wall single lever sink mixer 15 cm
short spout

Ref.: 61190 28 45 66



Monomando de fregadera mural 15 cm K8

K8 Wall single-lever sink mixer 15 cm

Ref.: 61192 28 45 66

Cartucho $\varnothing 40$ Cartridge



Monomando de fregadera mural 11 cm K8

K8 Wall single lever sink mixer 11 cm

Ref.: 61195 28 45 66



Monomando de fregadera caño inferior elevado K8

Wall single lever sink mixer
low spout K8

Ref.: 61196 28 45 66

Cartucho $\varnothing 35$ Cartridge



Monomando de fregadera mural 8"

Wall single lever 8" sink mixer

Ref.: 60194 05 45 66

Cocinas / Kitchen

Fregaderas abatibles Folding sink mixers

Cartucho $\varnothing 35$ Cartridge



**Monomando de fregadera abatible
cartucho 35 apertura en frío Tau**
Tau Single lever folding sink mixer
35 cartridge cold start
Ref.: 65900 18 45 66

Cartucho $\varnothing 40$ Cartridge



Monomando de fregadera abatible K8
K8 Single lever folding sink mixer
Ref.: 61900 28 45 66



Fregaderas selección Inox Stainless steel selection sink mixers



Beneficios del acero inoxidable en la cocina:

La serie Inox está diseñada especialmente para el mundo de la cocina, su material es ideal para cubrir todas las garantías de higiene y sanitarias y resultan más inalterables al uso.

Benefits of stainless steel in the kitchen:

The Inox series is specially designed for the kitchen world, its material is ideal to cover all hygiene and sanitary guarantees and is more unalterable when used.

Cartucho **Ø35** Cartridge



Monomando de fregadera Acero Inoxidable caño cisne

Stainless steel single lever sink mixer with swan pipe
Ref.: 65203 18 60 66



Monomando de fregadera Acero Inoxidable con muelle

Stainless steel single lever sink mixer with spring
Ref.: 65211 18 60 66



Monomando de fregadera Acero Inoxidable con muelle y ducha extraíble

Stainless steel single lever sink mixer with spring and pull-out sprayer
Ref.: 65207 18 60 66

Cocinas / Kitchen

Fregaderas selección Inox Stainless steel selection sink mixers

Cartucho **Ø25** Cartridge



**Monomando de fregadera Acero Inoxidable
cartucho 25**

Stainless steel single lever sink mixer
25 cartridge

Ref.: 65215 40 60 66



**Monomando de fregadera Acero Inoxidable
cartucho 25**

Stainless steel single lever sink mixer
25 cartridge

Ref.: 65219 40 60 66





Ref.: 65125 40 60 66

Cocinas / Kitchen

Fregaderas Classic Classic sink mixers **Encimeras** Countertop

New Regent

Cartucho **Ø40** Cartridge



Monomando de fregadera bronce
Bronze sink mixer
Ref.: 68201 39 43 66



Monomando de fregadera cromo
Chromed sink mixer
Ref.: 68201 39 45 66

Montura cerámica Ceramic frame



Monobloc de fregadera bronce
Bronze sink mixer
Ref.: 68595 09 43 66



Monobloc de fregadera cromo
Chromed sink mixer
Ref.: 68595 09 45 66





Ref.: 68595 09 45 66

Cocinas / Kitchen

Fregaderas Classic Classic sink mixers

Encimeras Countertop

New Regent

Montura cerámica Ceramic frame



Monobloc fregadera caño tubo
Sink mixer, swan neck spout
Ref.: 68540 09 45 66



Grifo fregadera encimera caño tubo vertical
Deck sink tap with swan neck spout
Ref.: 68585 09 45 66



Mezclador mesada 8" caño tubo
8" deck mixer with swan neck spout
Ref.: 68545 09 45 66



Mezclador mesada 16 cm caño tubo
16 cm deck mixer with swan neck spout
Ref.: 68194 09 45 66



Fregaderas Classic Classic sink mixers

Encimeras Countertop

Gamma

Montura convencional Conventional frame



Monobloc de fregadera caño tubo
Sink mixer, swan neck spout
Ref.: 68200 11 45 66



Mezclador mesada 6" caño tubo
6" deck mixer with swan neck spout
Ref.: 68194 11 45 66



Mezclador mesada 8" caño tubo
8" deck mixer with swan neck spout
Ref.: 68199 11 45 66



Grifo fregadera encimera caño tubo vertical
Deck sink tap with swan neck spout
Ref.: 68003 11 45 66

La grifería GENE BRE está diseñada y fabricada según los estándares europeos de calidad, como la UNE-EN 19703 ofreciendo la funcionalidad, durabilidad y seguridad esperadas.

GENEBRE taps are designed and manufactured according to European quality standards, such as UNE-EN 19703, offering the expected functionality, durability and safety.

Cocinas / Kitchen

Fregaderas Classic Classic sink mixers

Mural Wall

New Regent

Montura cerámica Ceramic frame



**Grupo mural fregadera 15 cm
caño tubo alto 24 cm**

Wall sink mixer with 15 cm with high tube,
24 cm spout

Ref.: 68555 09 45 66

**Grupo mural fregadera 15 cm
caño tubo bajo 24 cm**

Wall sink mixer with 15cm low tube, +
24 cm spout

Ref.: 68560 09 45 66

**Grupo mural fregadera 11 cm
caño tubo alto 24 cm**

Wall sink mixer with 11cm high tube,
24 cm spout

Ref.: 68196 09 45 66



**Grupo mural fregadera 11 cm
caño tubo alto 18 cm**

Wall sink mixer with 11 cm high tube,
18 cm spout

Ref.: 68550 09 45 66

**Grupo mural fregadera 20 cm
caño tubo alto 24 cm**

20 cm wall sink mixer with high tube,
24 cm spout

Ref.: 68565 09 45 66

**Grupo mural fregadera 20 cm
caño tubo alto vertical**

20 cm wall sink mixer with swan neck spout

Ref.: 68570 09 45 66

Fregaderas Classic Classic sink mixers

Mural Wall

New Regent

Montura cerámica Ceramic frame

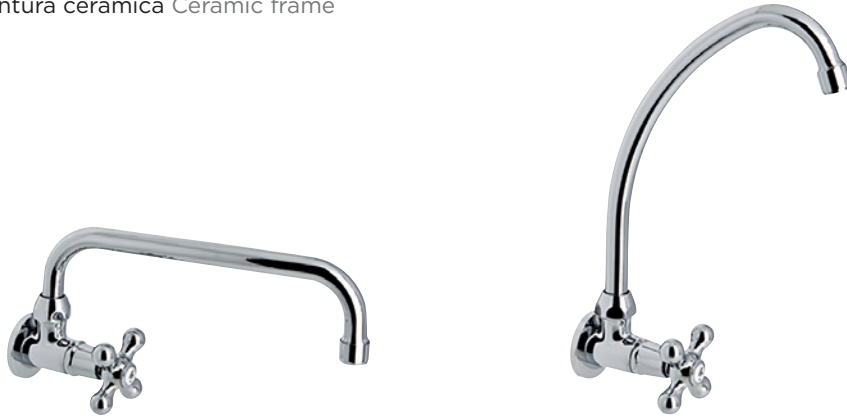

Grifo mural fregadera caño tubo alto 24 cm

Wall sink tap with tube spout 24 cm

Ref.: 68580 09 45 66

Grifo fregadera mural caño tubo vertical

Wall sink tap with swan neck spout

Ref.: 68575 09 45 66



Cocinas / Kitchen

Fregaderas Classic Classic sink mixers

Mural Wall

New Regent

Montura cerámica Ceramic frame



Cuerpo grupo mural 20 cm

Wall body mixer 20 cm

Ref.: 568565 45



Cuerpo grupo mural 15 cm

Wall body mixer 15 cm

Ref.: 568555 45



Cuerpo grupo mural 11 cm

Wall body mixer 11 cm

Ref.: 568550 45



Cuerpo grifo mural

Wall body tap

Ref.: 568575 45



Caño alto tubo 18 cm

High pipe spout 18 cm

Ref.: 68901 45

Caño alto tubo 24 cm

High pipe spout 24 cm

Ref.: 68902 45

Caño alto tubo 30 cm

High tube spout 30 cm

Ref.: 68908 45



Caño tubo vertical

Vertical pipe spout

Ref.: 68903 45



Caño bajo tubo 18 cm

Low tube spout 18 cm

Ref.: 68910 45

Caño bajo tubo 24 cm

Low tube spout 24 cm

Ref.: 68904 45

Caño bajo tubo 30 cm

Low tube spout 30 cm

Ref.: 68909 45



Cocinas / Kitchen

Fregaderas Classic Classic sink mixers

Mural Wall

Gamma

Montura convencional Conventional frame



**Grupo mural fregadera 15 cm
caño tubo alto 24 cm**
Wall sink mixer with 15 cm with high tube,
24 cm spout
Ref.: 68193 11 45 66



**Grupo mural fregadera 15 cm
caño tubo bajo 24 cm**
Wall sink mixer with 15cm low tube,
24 cm spout
Ref.: 68197 11 45 66



**Grupo mural fregadera 11 cm
caño tubo alto 24 cm**
Wall sink mixer with 11 cm,
high tube 24 cm spout
Ref.: 68196 11 45 66



**Grupo mural fregadera 11 cm
caño tubo alto 18 cm**
Wall sink mixer with 11cm high tube,
18 cm spout
Ref.: 68195 11 45 66



**Grupo mural fregadera 20 cm
caño tubo alto 24 cm**
20 cm wall sink mixer with high tube,
24 cm spout
Ref.: 68104 11 45 66



**Grupo mural fregadera 20 cm
caño tubo alto vertical**
20 cm wall sink mixer
with swan neck spout
Ref.: 68103 11 45 66

Fregaderas Classic Classic sink mixers

Mural Wall

Gamma

Montura convencional Conventional frame



Grupo mural fregadera 15 cm caño tubo alto 18 cm

Wall sink mixer with 15 cm, high tube,
18 cm spout

Ref.: 68190 11 45 66



Grifo mural fregadera caño tubo alto 24 cm

Wall sink tap with tube spout 24 cm

Ref.: 68093 11 45 66



Grifo fregadera mural caño tubo vertical

Wall sink tap with swan neck spout

Ref.: 68083 11 45 66



Cocinas / Kitchen

Fregaderas Classic Classic sink mixers

Mural Wall

Gamma

Montura convencional Conventional frame



Cuerpo grupo mural 20 cm
Wall body mixer 20 cm
Ref.: 568104 45



Cuerpo grupo mural 15 cm
Wall body mixer 15 cm
Ref.: 568193 45



Cuerpo grupo mural 11 cm
Wall body mixer 11 cm
Ref.: 568195 45



Cuerpo grifo mural
Wall body tap
Ref.: 568083 45



Caño alto tubo 18 cm
High pipe spout 18 cm
Ref.: 68901 45

Caño alto tubo 24 cm
High pipe spout 24 cm
Ref.: 68902 45

Caño alto tubo 30 cm
High tube spout 30 cm
Ref.: 68908 45



Caño tubo vertical
Vertical pipe spout
Ref.: 68903 45



Caño bajo tubo 18 cm
Low tube spout 18 cm
Ref.: 68910 45

Caño bajo tubo 24 cm
Low tube spout 24 cm
Ref.: 68904 45

Caño bajo tubo 30 cm
Low tube spout 30 cm
Ref.: 68909 45



Cocinas / Kitchen

Fregaderas de 1 agua One-water sink taps



**Grifo mural con tubo 24 cm
1 agua cartucho 25**
One-water wall sink tap spout 24 cm
25 cartridge
Ref.: 1008 04



Grifo fregadera 1 agua cartucho 25
One-water sink tap 25 cartridge
Ref.: 1009 04



**Grifo mural con tubo alto
1 agua cartucho 25**
One-water wall sink tap high spout
25 cartridge
Ref.: 1005 04





Grifo lavabo mural 1 agua cartucho 25
One-water wall wash-basin tap 25 cartridge
Ref.: 1003 04



**Grifo doble combinable a 1/2"- 3/4"
y Aireador**
Double outlet tap 1/2" - 3/4" and aerator
Ref.: 1024 04



Grifo doble combinable 1/2"-3/4" y 1/2"
Double outlet tap 1/2"-3/4" and 1/2"
Ref.: 1023 04



Grifo lavabo 1 agua cartucho 25
One-water wash-basin tap 25 cartridge
Ref.: 1002 04



Grifo lavabo 1 agua cartucho 25
One-water wash-basin tap 25 cartridge
Ref.: 1007 04



Grifo lavabo mural 1 agua cartucho 25
One-water wall wash-basin tap 25 cartridge
Ref.: 1006 04



Accesorios

Accessories

HASTA EL ÚLTIMO DETALLE

Genebre te ofrece una larga lista de accesorios y complementos funcionales y decorativos ideales para combinar con nuestros modelos de grifería y dar un toque personal a cada baño.

DOWN TO THE LAST DETAIL

Genebre offers a long list of accessories and functional and decorative complements, ideal to combine with our models of taps, and give a personal touch to each bathroom.

Mangos de ducha Handshowers

* Flexo no incluídos
* Hose not included



Mango de ducha K3 jets
K3 jets handshower
Ref.: DXK3 45



Mango de ducha K1 jets
K1 jet handshower
Ref.: DXK1 45



Mango de ducha O3 jets
O3 jets handshower
Ref.: DXO3 45



Mango de ducha 3 jets negro
Black 3 jets hand shower
Ref.: 9908 0284



Mango de ducha T3 jets
T3 jets handshower
Ref.: DXT3 45



Mango de ducha T5 jets
T5 jets handshower
Ref.: DXT5 45



Mango de ducha E1 jet
E1 jet handshower
Ref.: 100175 45 00



Mango de ducha E2 jets
E2 jets handshower
Ref.: DXE2 45



Mango de ducha E5 jets
E5 jets handshower
Ref.: DXE5 45



Mango de ducha C1 jet
C1 jet handshower
Ref.: 100197 45 00

Kits de ducha Shower kits

* Flexo incluido
* Hose included



Kit de ducha Kenjo, flexo, soporte y ducha 3 jets
Kenjo shower set, flexible hose, holder and 3 jets handshower
Ref.: 100698 45



NEW

Mango de ducha 3 jets negro
Black 3 jets hand shower
Ref.: 9908 0284

Flexo H 1/2" - H 1/2" 1,70 m inoxidable negro
F 1/2" - F 1/2" Black stainless steel flexible hose 1.70 m
Ref.: 9908 0287

Soporte ducha Negro
Black Shower holder
Ref.: 9908 0286



Kit de ducha Tau, flexo, soporte y ducha 5 jets
Tau shower set, flexible hose, holder and 5 jets handshower
Ref.: 100699 45



Kit de ducha GE2, flexo, soporte y ducha 1 jet
GE2 shower set, flexible hose, holder and 1 jet handshower
Ref.: 100697 45

Flexos Flexible hoses



Flexo H 1/2" - H 1/2" 1,20 m inoxidable
F 1/2" - F 1/2" Stainless steel flexible hose 1.20 m
Ref.: 100141 45



Flexo H 1/2" - H 1/2" 1,70 m inoxidable
F 1/2" - F 1/2" Stainless steel flexible hose 1.70 m
Ref.: 100135 60 00



Flexo extensible H 1/2" - H 1/2" 1,70 - 2,25 m inoxidable
F 1/2" - F 1/2" Extensible stainless steel flexible hose 1.70 to 2.25 m
Ref.: 100137 60 00



Flexo H 1/2" - H 1/2" 1,70 m. PVC antirrotura
F 1/2" - F 1/2" PVC flexible hose 1.70 m anti-breaking
Ref.: 100140 30



NEW

Flexo H 1/2" - H 1/2" 1,70 m inoxidable negro
F 1/2" - F 1/2" Black stainless steel flexible hose 1.70 m
Ref.: 9908 0287

Soportes de ducha Shower holders

* Toma de agua no incluida
* Wall connectors not included



Soporte ducha Kenjo
Kenjo shower holder
Ref.: 100149 45



Soporte ducha
Shower holder
Ref.: 100152 45 00



Soporte ducha cilíndrico
Cylindrical shower holder
Ref.: 100153 45



Soporte ducha ovalado
Oval shower holder
Ref.: 100068 45



Soporte de ducha orientable cuadrado con toma 1/2"
Orientable square shower holder with 1/2" connector
Ref.: 1649 04



NEW

Soporte de ducha cuadrado con toma 1/2"
Square shower holder with 1/2" connector
Ref.: 1635 04



NEW

Soporte de ducha cilíndrico con toma 1/2" Negro
Black Cylindrical shower holder with 1/2" connector
Ref.: 1946 41



NEW

Soporte de ducha cilíndrico con toma 1/2"
Cylindrical shower holder with 1/2" connector
Ref.: 1634 04



Soporte de ducha orientable cilíndrico con toma 1/2"
Orientable cylindrical shower holder with 1/2" connector
Ref.: 1633 04

Tomas de agua para ducha Wall connectors



Toma ducha mural cuadrada
Square wall connector
Ref.: 1679 04



Toma ducha mural redonda
Round wall connector
Ref.: 1680 04

Conjuntos barra Bar sets

* Mango y flexo incluidos
* Handshower and hose included



Conjunto Kenjo, barra, flexo y ducha 3 jets
Kenjo set, bar, flexible hose and 3 jets handshower
Ref.: 1747 45



Conjunto Tau, barra, flexo y ducha 5 jets
Tau set, bar, hose and 5 jets handshower
Ref.: 1748 45



Barra ducha Shower bars

* Mango y flexo no incluidos
* Handshower and hose not included



Barra ducha Kenjo
Kenjo shower bar
Ref.: 1637 45



Barra ducha redonda
Round shower bar
Ref.: 1638 45



Barra ducha metálica
Metallic shower bar
Ref.: 1639 45



Barra ducha TAU
TAU shower bar
Ref.: 1636 45

Rociadores y brazos

Shower heads and sprayer arms

Brazo a pared

Wall arm



Rociador doble función cascada-lluvia
Shower head double function waterfall-rain
Ref.: 1643 45



Brazo pared cuadrado 35 cm
Square wall arm 35 cm
Ref.: B63113 26



Rociador cuadrado 22 cm
Square shower head 22 cm
Ref.: R63112 26



Brazo pared redondo 35 cm
Round wall arm 35 cm
Ref.: B65113 18



Brazo pared redondo 35cm Bronce
Bronze round wall arm 35cm
Ref.: B64113 43



Brazo pared redondo 35 cm negro
Black round wall arm 35 cm
Ref.: B64113 41

Rociador redondo 22 cm
Round shower head Ø 22 cm
Ref.: R65112 18

Rociador redondo 20cm Bronce
Bronze round shower head 20cm
Ref.: R68113 43

Rociador D22 Oslo Black
Oslo Black D22 shower head
Ref.: R65112 41



Rociador ducha con brazo
Wall shower arm and spray
Ref.: 1698 45 00



Brazo pared redondo 24 cm
Round wall 24 cm
Ref.: B65114 18
Ref.: 1699 45 00

Rociador cilíndrico 10cm
Cylindrical shower head 10cm
Ref.: 1155 04

Rociadores y brazos Shower heads and sprayer arms

Brazo a techo
Roof arm



Brazo a techo cuadrado 15 cm

Square roof arm 15 cm

Ref.: 1672 45

Rociador cuadrado 22 cm

Square shower head 22 cm

Ref.: R63112 26



Brazo a techo redondo 15 cm

Round roof arm 15 cm

Ref.: 1671 45

Rociador D22 ovalado

Oval D22 shower sprayer

Ref.: R63112 08



NEW

Brazo a techo redondo 15 cm negro

Black round roof arm 15 cm

Ref.: 1671 41

Rociador D22 Oslo Black

Oslo Black D22 shower head

Ref.: R65112 41



Brazo a techo redondo 15 cm

Round roof arm 15 cm

Ref.: 1671 45

Rociador redondo 22 cm

Round shower head Ø 22 cm

Ref.: R65112 18

Válvulas de escuadra Angle valves

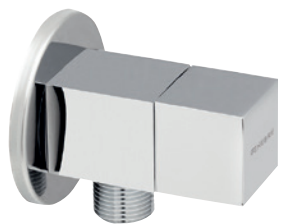

Válvula de escuadra cuadrada 3/8"
Square angle valve 3/8"
Ref.: 3106 04

Válvula de escuadra cuadrada 1/2"
Square angle valve 1/2"
Ref.: 3106 05



Válvula de escuadra redonda 3/8"
Round angle valve 3/8"
Ref.: 3104 04

Válvula de escuadra redonda 1/2"
Round angle valve 1/2"
Ref.: 3104 05



Válvula de escuadra redonda 3/8" Negro
Black Round angle valve 3/8"
Ref.: 3110 03 41

Válvula de escuadra redonda 1/2" Negro
Black Round angle valve 1/2"
Ref.: 3110 04 41



Válvula de escuadra doble 1/2" - 3/8"
Double angle valve 1/2" - 3/8"
Ref.: 3109 04

Válvula de escuadra doble 1/2" - 1/2"
Double angle valve 1/2" - 1/2"
Ref.: 3109 05

Kit ducha sanitaria Sanitary shower kit



Kit ducha sanitaria Negro
Black Sanitary shower kit
Ref.: 100694 41



Kit ducha sanitaria
Sanitary shower kit
Ref.: 100694 45



Kit ducha sanitaria inox
Stainless steel sanitary shower kit
Ref.: 100694 60



Kit ducha sanitaria
Sanitary shower kit
Ref.: 100696 45



Llave de paso 1/2"
1/2" Stopcock
Ref.: 60170 41 45 66



Llave de paso 3/4"
3/4" Stopcock
Ref.: 60171 41 45 66

Mezcladores sanitarios Sanitary shower mixers



NEW

Mezclador sanitario de ducha con soporte Negro
Black Sanitary shower mixer with support
Ref.: 65144 19 41 67



NEW

Mezclador sanitario de ducha con soporte
Sanitary shower mixer with support
Ref.: 65144 19 45 67



NEW

Set mezclador sanitario de ducha con soporte
Sanitary shower mixer set with support
Ref.: 65144 19 45 66

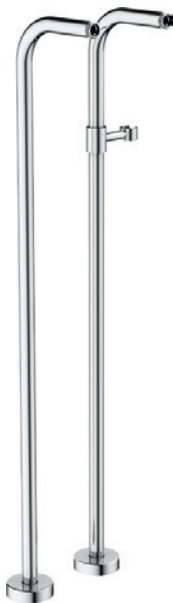

NEW

Pies para mezclador de bañera
Floor support for bath mixer
Ref.: 65120 45



Caños lavabo Wash basin spout

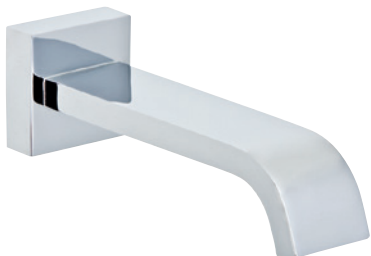

Caño mural baño cuadrado
Square wall bath spout
Ref.: 1674 45



Caño mural baño cilíndrico
Round wall bath spout
Ref.: 1668 45



Caño mural baño cilíndrico Negro
Black Round wall bath spout
Ref.: 1668 41



Caño mural baño fundido
Casted wall bath spout
Ref.: 1667 45



Caño mural tubo recto 16 cm
Wall-mounted pipe spout 16 cm
Ref.: 68911 45



Caño mural tubo recto 22 cm
Wall-mounted pipe spout 22 cm
Ref.: 68912 45



Caño mural tubo inclinado 20 cm
Wall-mounted sloping pipe spout 20 cm
Ref.: 68913 45



Caño mural tubo retro 20 cm
Wall-mounted retro pipe spout 20 cm
Ref.: 68914 45



Caño encimera recto tubo
Straight pipe spout
Ref.: 68915 45



Caño encimera cisne tubo
Swan neck pipe spout
Ref.: 68916 45



Caño encimera inclinado tubo
Sloping pipe spout
Ref.: 68917 45



Válvulas de desagüe Drain valves



Válvula universal click Luxe con y sin rebosadero
Luxe universal click pop-up waste with and without overflow
Ref.: 100211 45



NEW

Válvula universal click Luxe con y sin rebosadero Negro
Black luxe universal click pop-up waste with and without overflow
Ref.: 100211 41



Válvula universal click Luxe con y sin rebosadero bronce
Bonze Luxe universal click pop-up waste with and without overflow
Ref.: 100211 43



Tapa universal "Click remove"
"Click remove" universal cover
Ref.: 100202 45



NEW

Válvula universal click con y sin rebosadero
Universal click pop-up waste with and without overflow
Ref.: 100205 45



Válvula universal click Kenjo con y sin rebosadero
Kenjo universal click pop-up waste with and without overflow
Ref.: 100204 45



Válvula universal click lavabo y bidé click con rebosadero
Click pop-up waste for basin and bidet with overflow
Ref.: 100206 45



Válvula universal lavabo y bidé click
Click pop-up waste for basin and bidet
Ref.: 100207 45



Válvula universal click para bañera
Click pop-up waste for bath
Ref.: 100208 45



NEW

Válvula universal click para bañera Bronce
Bronze Click pop-up waste for bath
Ref.: 100208 43



NEW

Válvula universal click lavabo y bidé click doble función
double function click pop-up waste for basin and bidet
Ref.: 100209 45



NEW

Válvula universal click lavabo y bidé click doble función
Double function click pop-up waste for basin and bidet
Ref.: 100210 45



Válvula automática plástico 1 1/4"
1 1/4" plastic automatic valve
Ref.: 100200 45



Válvula automática metálica 1 1/4"
1 1/4" metallic automatic valve
Ref.: 100203 45

Sifones Siphons



Sifon botella cuadrado para lavabo y bidé 1 1/4"
Square 1 1/4" bidet and wash-basin siphon
Ref.: 1621 07

Opcional In option

Tubo alargado vertical sifón 1 1/4"
Vertical enlarge tube 1 1/4" siphon
Ref.: 1632 00

Tubo alargado horizontal sifón 1 1/4"
Horizontal enlarge tube 1 1/4" siphon
Ref.: 1640 07



Sifon botella redondo para lavabo y bidé 1 1/4"
Round 1 1/4" bidet and wash-basin siphon
Ref.: 1622 07

Opcional In option

Tubo alargado vertical sifón 1 1/4"
Vertical enlarge tube 1 1/4" siphon
Ref.: 1632 00

Tubo alargado horizontal sifón 1 1/4"
Horizontal enlarge tube 1 1/4" siphon
Ref.: 1640 07

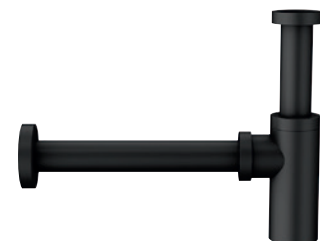

NEW

Sifón botella para lavabo y bidé 1 1/4" negro
Black 1 1/4" bidet and basin siphon
Ref.: 1626 41

Opcional In option

Tubo alargado vertical sifón 1 1/4" negro
Black vertical enlarge tube 1 1/4" siphon
Ref.: 1632 41

Tubo alargado horizontal sifón 1 1/4" Negro
Black horizontal enlarge tube 1 1/4" siphon
Ref.: 1640 41

Reguladores de caudal Flow regulator

Para duchas
For showers



Conector 1/2" con regulador caudal
1/2" Connector with flow regulator

Consumo litros x minuto
Consumption in litres x minute

Ref.: 9908 0300	3L
Ref.: 9908 0301	4L
Ref.: 9908 0302	5L
Ref.: 9908 0303	6L
Ref.: 9908 0304	8L
Ref.: 9908 0305	10L
Ref.: 9908 0306	12L
Ref.: 9908 0307	14L

Aireadores Aerators

Para grifos
For taps



Aireador M24x1 antical economizador
M24x1 Anti-lime economizer aerator

Consumo litros x minuto
Consumption in litres x minute

Ref.: 9908 0311	2L
Ref.: 9908 0312	4L
Ref.: 9908 0313	5L
Ref.: 9908 0314	6L
Ref.: 9908 0315	8L

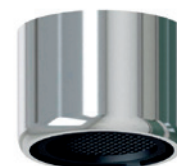

Aireador H22x1 antical economizador
F22x1 Anti-lime economizer aerator

Consumo litros x minuto
Consumption in litres x minute

Ref.: 9908 0317	2L
Ref.: 9908 0318	4L
Ref.: 9908 0319	5L
Ref.: 9908 0320	6L
Ref.: 9908 0321	8L

Ahorro de agua y energía Water and energy saving

Ahora GENE BRE presenta su amplia gama de economizadores, tanto para baño como cocina.

Nuestros conectores con regulador de caudal para ducha y aireadores antical economizadores ideales para grifos, harán que tus instalaciones sean más eficientes en el consumo de agua y energía.

Consumo más sostenible

Gracias al sistema de regulación dinámica, la reducción se produce sea cual sea la presión del agua.

En los aireadores, su mezclado de agua con aire ofrece una gran sensación de confort, a la vez que se reduce el consumo, haciéndolo más eficiente y sostenible. Además, al reducir su caudal, también se ahorra energía en la fase de calentamiento del agua.



Ahorro de agua, hasta 20 litros minuto.
Water saving, up to 20 litres minute

Now GENE BRE presents its wide range of economizers, for both bathroom and kitchen.

Our connectors with flow regulator for showers, and antical economizing aerators ideal for taps, will make your installations more efficient in terms of water and energy consumption.

More sustainable consumption

Thanks to the dynamic regulation system, the reduction occurs whatever the water pressure.

In aerators, mixing water with air offers a great feeling of comfort, while reducing consumption, making it more efficient and sustainable. In addition, by reducing the flow, you also save energy in the water heating phase.

Los economizadores GENE BRE ayudan a conseguir las certificaciones más exigentes.
The GENE BRE economizers help achieve the most demanding certifications.



Para instalaciones con baja presión, recomendamos los aireadores ref. **9908 0310** (M24X1) y **9908 0316** (H22X1), ofrecen alta sensación de confort con consumo de 5 litros a los 0,2 Bar.

For installations with very low pressure, we offer aerators ref. **9908 0310** (M24X1) and **9908 0316** (F22X1), that offer a great feeling of comfort with a consumption of 5 litres at 0.2 Bar.

Filtros Filters



Kit declorador
Dechlorinator kit
Ref.: FT00



NEW

Kit ultrafiltración
Ultrafiltration kit
Ref.: FT01

Accesorios Accessories



Conjunto florón y excéntricas gigantes
Giant scutcheon and eccentric set
Ref.: 100122 45



Placa adaptadora 4"
4" adaptor plate
Ref.: P130



Placa adaptadora 8"
8" adaptor plate
Ref.: P200





Recambios

Spare parts

La importancia de las piezas

Es importante disponer de las piezas de recambio para mantener el baño siempre en perfecto estado aunque pase el tiempo. Por eso, contamos con una gran colección de piezas exclusivas con la misma calidad de siempre.

The importance of the parts.

It is important to have the spare parts available to always keep the bathroom in a perfect state through the pass of time. Therefore, we have a large collection of exclusive pieces with the same quality as always.



Maneta
Handle

Ref.: Descripción | Description

100001 05 45	Maneta Sara Sara lever
100001 06 45	Maneta Sigma Sigma lever
100001 08 45	Maneta Kode Kode lever
100001 14 45	Maneta Klip 2 Klip 2 lever
100001 16 45	Maneta Klip Klip lever
100001 18 45	Maneta Tau Tau lever
100001 19 45	Maneta Oslo Oslo lever
100001 22 45	Maneta GE2 GE2 lever
100001 26 45	Maneta Kenjo Kenjo lever
100001 28 45	Maneta K8 K8 lever
100001 29 45	Maneta Tau 2 Tau 2 lever
100001 31 45	Maneta Kode corta Short Kode lever
100001 32 45	Maneta Koral Koral lever
100001 33 45	Maneta GE2 corta Short GE2 lever
100001F 16 45	Maneta Kelogic Kelogic lever
100001R 16 45	Maneta Kelogic marcado vertical Vertical marked Kelogic lever
100001R 19 45	Maneta Oslo marcado frio vertical Vertical marked cold Oslo lever
100001T 32 45	Maneta columna Koral Koral column lever
100001V 05 45	Maneta Sara marcado vertical Vertical marked Sara lever
100001V 06 45	Maneta Sigma marcado vertical Vertical marked Sigma lever
100001V 14 45	Maneta Klip 2 marcado vertical Vertical marked Klip2 lever
100001V 16 45	Maneta Klip marcado vertical Vertical marked Klip lever
100001V 18 45	Maneta Tau marcado vertical Vertical marked Tau lever
100001V 18 60	Maneta Tau Inox marcado vertical Vertical marked Tau Inox lever
100001V 19 45	Maneta Oslo marcado vertical Vertical marked Oslo lever
100001V 28 45	Maneta K8 marcado vertical Vertical marked K8 lever
100001V 32 45	Maneta Koral marcado vertical Vertical marked Koral lever
100001V 33 45	Maneta GE2 corta marcado vertical Vertical marked short GE2 lever
100001V 37 45	Maneta Tau 35 marcado vertical Vertical marked Tau 35 lever
100001V 39 43	Maneta New Regent marcado vertical bronce Vertical marked New Regent bronze lever
100001V 39 45	Maneta New Regent marcado vertical Vertical marked New Regent lever
100001V 40 60	Maneta Flat Flat handle
9908 0039	Maneta FRT65401 FRT65401 lever
9908 0040	Maneta FRT65402 FRT65402 lever
9908 0041	Maneta FRV61205 FRV61205 lever
9908 0045	Maneta FRK FRK lever
9908 0218	Maneta columna Tau D35 D 35 Tau column handle
9908 0219	Maneta columna Tau 2 D35 D35 Tau 2 column handle
9908 0222	Maneta para FRV61207 Blanca White Lever for FRV61207
9908 0225	Maneta para FRV61207 Negra Black Lever for FRV61207
9908 0392	Maneta para FRV61207 a. INOX F. SS Lever for FRV61207
9908 0235	Maneta inversor columna Oslo Oslo column diverter lever
9908 0370	Maneta inversor columna Oslo Negro Black Oslo column diverter lever
9908 0241	Maneta FRT65401 Blanca White FRT65401 lever
9908 0243	Maneta FRT65401 Negra Black FRT65401 lever
9908 0251	Maneta para 65212 18 45 66 Lever for 65212 18 45 66
9908 0278	Maneta Oslo Negra Black Oslo lever
9908 0352	Maneta para 65703 18 60 66 Lever for 65703 18 60 66
9908 0389	Maneta FRT65401 a. INOX F. SS FRT65401 lever
9908 0395	Maneta FRV61208 Lever for FRV61208



Maneta
Handle

Ref.: Descripción | Description

9908 0398	Maneta FRV61208 Negra Black Lever for FRV61208
9908 0438	Maneta FRV61208 a. INOX F. SS Lever for FRV61208
9908 0455	Maneta mezclador sanitario Lever sanitary mixer
9908 0459	Maneta mezclador sanitario Negra Black sanitary mixer lever

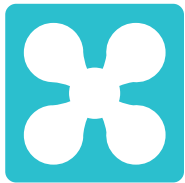

Volantes
Handles

Ref.: Descripción | Description

68988 18	Kit volantes columnas termostáticas Tau Tau thermostatic column handle set
68989 26	Kit volantes columnas termostáticas Kenjo Kenjo thermostatic column handle set
68991 14	Kit volantes termostática Tau Tau thermostatic mixer handle set
68992 26	Kit volantes termostáticas Kenjo Kenjo thermostatic mixer handle set
68994 14	Kit volantes termostática Thermostatic mixer handle set
68998 07 45	Volante Kalo Kalo handle
68998 08 45	Volante Kross Kross handle
68998 09 43	Volante Regent bronce Bronze Regent handle
68998 09 45	Volante Regent Regent handle
68998 11 45	Volante Gamma Gamma handle
68998 12 45	Volante Ixo Ixo handle
68998 28 45	Volante Office Office handle
68998 30 45	Volante Tau Tau handle
68998 31 45	Volante osmosis Osmosis handle
9908 0056	Kit volante termostatica empotrada 2 y 3 vías Built-in 2 and 3 ways thermostatic handle set
9908 0100	Cobertor cartucho termostático Thermostatic cartridge cover
9908 0101	Volante cartucho termostático Thermostatic cartridge handle
9908 0205	Volante inversor set redondo Round set diverter handle
9908 0215	Volante inversor set cuadrado Square set diverter handle
9908 0217	Volante inversor columna redonda Round column diverter handle
9908 0220	Kit volantes columnas monomando cuadradas Square single handle column handle set
9908 0234	Volante inversor set Oslo Oslo set diverter handle
9908 0376	Volante inversor set Oslo Negro Black Oslo set diverter handle
9908 0239	Volante montura columna Oslo Oslo column headwork handle
9908 0373	Volante inversor columna Oslo Negro Black Oslo column diverter handle
9908 0240	Volante cartucho columna Oslo Oslo column cartridge handle
9908 0375	Volante cartucho columna Oslo Negro Black Oslo column cartridge handle
9908 0272	Volante grifo de 1 vía Handle for one way tap
9908 0355	Volante Inox 3 vías SS 3 way handle
9908 0451	Volante llave de paso Stopcock handle



Florón
Scutcheon

Ref.: Descripción | Description

9908 0102	Florón para 568120 45 Scutcheon for 568120 45
9908 0103	Soporte florón para 568120 45 Scutcheon support for 568120 45
9908 0379	65200 19 45 66 Base Base to 65200 19 45 66
9908 0386	Florón deslizante Sliding cover



Duchas
Shower

Ref.: Descripción | Description

100131 60	Mango ducha inoxidable SS hand shower
100175 45 00	Mango de ducha E1 jet E1 jet handshower
100187 45	Mango ducha extraíble para 65206 Pull-out 65206 sink tap sprayer
100190 45	Mango ducha de fregadera extraíble Pull-out sink tap sprayer
100196 43 00	Mango de ducha New Regent bronce New Regent bronze hand shower
100196 45 00	Mango de ducha New Regent cromo New Regent chromed hand shower
100197 45 00	Mango de ducha C1 jet C1 jet handshower
100199 45	Mango ducha extraíble para FRV61205 Pull-out FRV61205 sink tap sprayer
100252 45	Mango extraíble fregadera Pull-out sink tap sprayer
100696 45	Kit ducha sanitaria Sanitary shower kit
9908 0214	Mango ducha extraíble E1 Blanco White Pull-out E1 sink tap sprayer
9908 0223	Mango ducha extraíble E1 Negro Black Pull-out E1 sink tap sprayer
9908 0390	Mango ducha extraíble E1 a. INOX F. SS Pull-out E1 sink tap sprayer
9908 0246	Mango de ducha Handshower
9908 0248	Mango de ducha Handshower
9908 0255	Mango Ducha para 65212 18 45 66 Hand shower for 65212 18 45 66
9908 0260	Mango ducha extraíble E1 Pull-out E1 sink tap sprayer
9908 0284	Mango de ducha 3 jets negro Black 3 jets hand shower
DXK3 45	Mango de ducha K3 jets K3 jets handshower
DXL3 45	Mango de ducha L3 jets L3 jets handshower
DXT5 45	Mango de ducha T5 jets T5 jets handshower
R63112 26	Rociador cuadrado 22 cm Square shower head 22 cm
R65112 18	Rociador redondo 22 cm Round shower head Ø 22 cm
R65112 19	Rociador D22 Oslo Oslo D22 shower head
9908 0381	Ducha bidet con transmisión Shower bidet mixer with diverter
9908 0396	Mango ducha extraíble para FRV61208 Pull-out FRV61208 sink tap sprayer
9908 0399	Mango ducha extraíble para FRV61208 Negra Black Pull-out FRV61208 sink tap sprayer
9908 0435	Mango ducha extraíble para FRV61208 Blanca White Pull-out FRV61208 sink tap sprayer
9908 0439	Mango ducha extraíble para FRV61208 a. INOX F. SS Pull-out FRV61208 sink tap sprayer

Ref.: Descripción | Description

100135 43 00	Flexo H 1/2" - H 1/2" bronce 1,7 m F 1/2" - F 1/2" bronze 1.7 m flexible hose
100135 60 00	Flexo H 1/2" - H 1/2" 1,70 m inoxidable F 1/2" - F 1/2" Stainless steel flexible hose 1.70 m
100140 30	Flexo H 1/2" - H 1/2" 1,70 m. PVC antirrotura F 1/2" - F 1/2" PVC flexible hose 1.70 m anti-breaking
100141 45	Flexo H 1/2" - H 1/2" 1,20 m inoxidable F 1/2" - F 1/2" Stainless steel flexible hose 1.20 m
100143 45	Flexo flegadera 15 x 1 - H 1/2" 1,15 m 15 x 1 - F 1/2" 1,15 m pull-out sink tap hose
100143 60	Flexo fregadera para 65211 18 60 66 Sink tap hose for 65211 18 60 66
9908 0080	Flexo para 65207 18 60 66 Flexible hose for 65207 18 60 66
9908 0203	Flexo H 1/2" - H 1/2" 0,6 m cromado F 1/2" - F 1/2" 0.6 m chromed flexible hose
9908 0206	Flexo H 1/2" - H 1/2" 1,5 m cromado F 1/2" - F 1/2" 1.5 m chromed flexible hose
9908 0213	Flexo para FRV61207 Flexible hose for FRV61207
9908 0393	Flexo para FRV61207 a. INOX F. SS Flexible hose for FRV61207
9908 0256	Flexo para 65212 18 45 66 Flexible hose for 65212 18 45 66
9908 0258	Flexo para 65219 18 45 66 Flexible hose for 65219 18 45 66
9908 0262	Flexo para FRV61206 Flexible hose for FRV61206
9908 0287	Flexo H 1/2" - H 1/2" 1,70 m inoxidable negro F 1/2" - F 1/2" Black stainless steel flexible hose 1.70 m
9908 0368	Flexo H 1/2" - H 1/2" 1,5 m Negro F 1/2" - F 1/2" 1.5 m Black flexible hose
9908 0377	Flexo H 1/2" - H 1/2" 0,6 m Negro F 1/2" - F 1/2" 0.6 m Black flexible hose



Flexo
Flexible hose

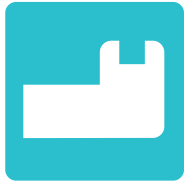

Soporte
Holder

Ref.:	Descripción Description
1000 67 45	Soporte ducha GE2 GE2 shower holder
100149 45	Soporte ducha Kenjo Kenjo shower holder
100152 45 00	Soporte ducha Shower holder
100153 45	Soporte ducha cilíndrico Cylindrical shower holder
1647 43	Soporte ducha Clásico bronce Classic bronze shower holder
1647 45	Soporte ducha Cásico Classic shower holder
9908 0172	Soporte superior set redondo Upper holder of round set
9908 0173	Soporte superior set cuadrado Upper holder of square set
9908 0226	Soporte columna redonda Round column holder
9908 0227	Soporte columna cuadrada Square column holder
9908 0232	Soporte columna Oslo Oslo column holder
9908 0245	Soporte deslizante columna Koral Koral column sliding shower holder
9908 0254	Soporte ducha para 65212 18 45 66 Shower holder for 65212 18 45 66
9908 0259	Soporte ducha para 65219 18 45 66 Shower holder for 65219 18 45 66
9908 0286	Soporte ducha Negro black Shower holder
9908 0457	Soporte mezclador sanitario Sanitary mixer shower holder
9908 0461	Soporte mezclador sanitario Negro Black sanitary mixer shower holder
1634 04	Soporte de ducha cilíndrico con toma 1/2" Cylindrical shower holder with 1/2" connector



Soportes ducha
deslizantes
Sliding shower
holders

Ref.:	Descripción Description
9908 0076	Soporte deslizante ducha para 1636 45 Sliding shower holder for 1636 45
9908 0077	Soporte deslizante ducha para 1637 45 Sliding shower holder for 1637 45
9908 0078	Soporte deslizante ducha para 1638 45 Sliding shower holder for 1638 45
9908 0079	Soporte deslizante ducha para 1639 45 Sliding shower holder for 1639 45
9908 0201	Soporte deslizante columna redonda Round column shower holder
9908 0211	Soporte deslizante columna cuadrada Square column shower holder
9908 0231	Soporte deslizante columna Oslo Oslo column sliding shower holder
9908 0367	Soporte deslizante columna Oslo Negro Black Oslo column sliding shower holder
9908 0366	Soporte columna Oslo Negro Black Oslo column holder



Caño
Spout

Ref.:	Descripción Description
68901 45	Caño alto tubo 18 cm High pipe spout 18 cm
68902 45	Caño alto tubo 24 cm High pipe spout 24 cm
68903 45	Caño tubo vertical Vertical pipe spout
68904 45	Caño bajo tubo 24 cm Low tube spout 24 cm
68911 45	Caño mural tubo recto 16 cm Wall-mounted pipe spout 16 cm
68912 45	Caño mural tubo recto 22 cm Wall-mounted pipe spout 22 cm
68913 45	Caño mural tubo inclinado 20 cm Wall-mounted sloping pipe spout 20 cm
68914 45	Caño mural tubo retro 20 cm Wall-mounted retro pipe spout 20 cm
68915 45	Caño encimera recto tubo Straight pipe spout
68916 45	Caño encimera cisne tubo Swan neck pipe spout
68917 45	Caño encimera inclinado tubo Sloping pipe spout
68922 45	Caño inferior elevado High lower spout
68924 45	Caño mural tubo recto 16 cm Wall mounted pipe spout 16 cm
68925 45	Caño mural tubo recto 22 cm Wall mounted pipe spout 22 cm
68926 45	Caño mural rectangular 16 cm Wall mounted rectangular pipe spout 16 cm
68927 45	Caño mural rectangular 22 cm Wall mounted rectangular pipe spout 22 cm
68928 45	Caño mural tubo recto 16 cm D20 D 20 Wall mounted pipe spout 16 cm
68929 45	Caño mural tubo recto 22 cm D20 D 20 Wall mounted pipe spout 22 cm
9908 0253	Caño para 65212 18 45 66 Spout for 65212 18 45 66
9908 0290	Caño mural tubo recto 16 cm D20 Negro Black D20 wall mounted pipe spout 16 cm
9908 0291	Caño mural tubo recto 22 cm D20 Negro Black D20 wall mounted pipe spout 22 cm
9908 0382	Caño conformado vertical Vertical tube spout
9908 0383	Caño conformado Tube spout
9908 0384	Caño conformado corto Short tube spout



Aireador
Aerator

Ref.:	Descripción Description
100066 45	Aireador M18 x 1 antical M18 x 1 anti-lime aerator
100072 45	Aireador M24 x 1 antical antivandálico M24 x 1 Antivandal anti-lime aerator
100073 43	Aireador H22x1 antical bronce retro F22x1 bronze anti-lime retro aerator
100073 45	Aireador H22x1 antical retro F22x1 anti-lime retro aerator
100074 45	Aireador M24x1 antical economizador 8,5 litros M24x1 Economizer anti-lime 8.5 liters aerator
100078 45	Aireador H22 x 1 antical economizador (blister 2 u.) F22 x 1 Economizer anti-lime aerator (blister 2 u.)
100080 45	Aireador para 65203 18 45 66 65203 18 45 66 aerator
100082 45	Aireador 2 salidas antical Double flow anti-lime aerator
100083 43	Aireador M28x1 antical bronce M28x1 anti-lime bronze aerator
100083 45	Aireador M28x1 antical M28x1 anti-lime aerator
100085 43	Aireador M24x1 antical bronce M24x1 anti-lime bronze aerator
100085 45	Aireador M24x1 antical M24x1 anti-lime aerator
100086 43	Aireador M24x1 antical con rótula bronce M24x1 bronze anti-lime aerator w/ kneecap
100086 45	Aireador M24 x 1 antical con rótula M24 x 1 anti-lime aerator w/ kneecap
100088 45	Aireador H22x1 antical F22x1 anti-lime aerator
100089 45	Aireador H18 x 1 antical F18 x 1 aerator anti-lime



Aireador
Aerator

Ref.:	Descripción Description
9908 0026	Aireador para caño rectangular Rectangular spout aerator
9908 0043	Aireador para 65203 18 60 66 65203 18 60 66 aerator
9908 0044	Aireador para 65208 18 60 66 65208 18 60 66 aerator
9908 0216	Aireador M24x1 antical Blanco White M24x1 anti-lime aerator
9908 0224	Aireador M24x1 antical Negro Black M24x1 anti-lime aerator
9908 0242	Aireador H18x1 antical Blanco White F18x1 anti-lime aerator
9908 0244	Aireador H18x1 antical Negro Black F18x1 anti-lime aerator
9908 0267	Aireador antivandálico orientable Antivandal orientable aerator
9908 0268	Aireador antivandálico Antivandal aerator
9908 0281	Aireador M24x1 antical con rótula Negro Black M24x1 anti-lime aerator w/kneecap
9908 0351	Aireador H18x1 antical INOX SS F18X1 anti-lime aerator
9908 0378	Aireador H28x1 antical Negro Black F28X1 anti-lime aerator
9908 0385	Aireador M24X1 antical INOX SS M24X1 anti-lime aerator
9908 0388	Aireador H18x1 antical a. INOX F. SS F18x1 anti-lime aerator
9908 0391	Aireador M24X1 antical a. INOX F. SS M24X1 anti-lime aerator
9908 0397	Aireador 2 salidas antivandálico Double flow antivandal aerator
9908 0433	Aireador H24x1 antical F24x1 anti-lime aerator



Cartucho
Cartridge

Ref.:	Descripción Description
100036	Cartucho cerámico D35 salida libre 2 posiciones 2 Positions free flow D35 ceramic cartridge
100037	Cartucho termostático Thermostatic mixer cartridge
100042	Cartucho cerámico D25 convencional 1 agua 1 water conventional D25 ceramic cartridge
100044	Cartucho cerámico D25 convencional Conventional D25 ceramic cartridge
100045	Cartucho cerámico D40 convencional 2 posiciones 2 positions conventional D40 ceramic cartridge
100046	Cartucho cerámico progresivo Progressive ceramic cartridge
100047	Cartucho termóstatico D24 D24 thermostatic cartridge
9908 0374	Cartucho termóstatico D24 Negro Black D24 thermostatic cartridge
100048	Cartucho cerámico D40 salida libre 2 posiciones 2 positions free flow D40 ceramic cartridge
100049	Cartucho cerámico D40 convencional Conventional D40 ceramic cartridge
100051	Cartucho cerámico D40 salida libre Free flow D40 ceramic cartridge
100053	Cartucho cerámico D35 convencional Conventional D35 ceramic cartridge
100054	Cartucho cerámico D35 salida libre Free flow D35 ceramic cartridge
100057	Cartucho cerámico D25 convencional Conventional D25 ceramic cartridge
100058	Cartucho cerámico 2 vías 2-way ceramic cartridge
100064	Cartucho cerámico D40 junta superior salida libre 2 posiciones 2 positions free flow D40 ceramic cartridge upper gasket
9908 0051	Cartucho termostático empotrada Built-in tap thermostatic mixer cartridge
9908 0356	Cartucho D25 2 vías 2-way D25 cartridge



Montura
Headwork

Ref.:	Descripción Description
67895 45	Montura cerámica larga Ceramic long headwork
67896 45	Montura convencional larga Conventional long headwork
67897 45	Montura cerámica apertura derecha Clockwise opening ceramic headwork
67898 45	Montura cerámica larga apertura derecha Clockwise opening long ceramic headwork
67995 14	Montura cerámica termostática Thermostatic ceramic headwork
67997 45	Montura cerámica agua filtrada apertura derecha Clockwise opening filtered water ceramic headwork
67998 45	Montura cerámica agua filtrada Ceramic headwork filtered water
68995 09	Montura cerámica Ceramic headwork
68995 11	Montura convencional Conventional headwork
9908 0238	Montura cerámica para termostática Oslo Oslo thermostatic ceramic headwork
9908 0450	Montura cerámica para llave de paso 1/2" 1/2" stopcock ceramic headwork
9908 0454	Montura cerámica para llave de paso 3/4" 3/4" stopcock ceramic headwork

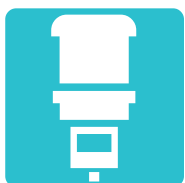

Inversor
Diverter

Ref.:	Descripción Description
100069	Inversor cerámico columna termostática Thermostatic column ceramic diverter
100117 45	Inversor compacto Oslo Oslo compact diverter
100157 45	Inversor Kelogic Kelogic diverter
100158 45	Inversor termostático Kenjo Kenjo thermostatic diverter
100159 45	Inversor cerámico termostática Thermostatic ceramic diverter
100160 45	Inversor ABS cromo ABS chromed diverter
100161 45	Inversor botón Button diverter
100162 45	Inversor largo baño empotrado Built-in large push-button diverter
100164 45	Inversor compacto Tau Tau compact diverter
100165 45	Inversor para termostático Klip Klip thermostatic diverter
100173 45	Inversor cerámico largo baño empotrado Built-in large push-button diverter
100174 45	Inversor convencional para batería bidet Bidet set conventional diverter
51745 45	Inversor columna redonda Round column diverter
51746 45	Inversor columna cuadrada Square column diverter
9908 0024	Inversor cerámico 2 vías 2 way ceramic diverter
9908 0025	Inversor cerámico 3 vías 3 way ceramic diverter
9908 0052	Inversor cerámico termostática 2 vías 2 way thermostatic tap ceramic diverter
9908 0054	Inversor cerámico termostática 3 vías 3 way thermostatic tap ceramic diverter
9908 0081	Inversor monomando bidé Single lever bidet diverter
9908 0204	Inversor set columna Column set diverter
9908 0221	Inversor columna monomando Single handle column diverter
9908 0233	Inversor cerámico columna Oslo Oslo column ceramic diverter
9908 0237	Inversor columna Oslo Oslo column diverter
9908 0247	Inversor para 62119 31 45 66 Diverter for 62119 31 45 66
9908 0249	Inversor para 63119 26 45 66 Diverter for 63119 26 45 66
9908 0252	Inversor para 65212 18 45 66 Diverter for 65212 18 45 66
9908 0288	Inversor compacto Oslo Negro Black Oslo compact diverter
9908 0343	Inversor largo baño empotrado Negro Black Built-in large push-button diverter
9908 0369	Inversor columna Oslo Negro Black Oslo column diverter
9908 0372	Inversor cerámico Ceramic diverter



Conexión flexible
Connection set

Ref.: Descripción | Description

100100	Juego de conexiones 10 x 1 - H 3/8" a 55 cm 10 x 1 - F 3/8" 55 cm connection set
100101	Conexión PEX 10x1 - H 3/8" a 15 cm 10x1 - F 3/8" 15 cm PEX connection
100103	Juego de conexiones 10x1 x H 3/8" a 35 cm 10x1 - F 3/8" 35 cm connection set
100104	Conexión PVC 10x1 - H 3/8" a 60 cm 10x1 - F 3/8" 60 cm PVC connection
100105	Juego de conexiones 10x1 - H 3/8" a 40 cm 10x1 - F 3/8" 40 cm connection set
100111	Juego de conexiones 10x1 - H 1/2" a 40 cm 10x1 - F 1/2" 40 cm connection set
100012	Conexión DN6 10x1 - 15x1 a 15 cm 10x1 - 15x1 15 cm DN6 connection
100113	Juego de conexiones DN6 10x1 - H 3/8" a 35 cm 10x1 - F 3/8" 35 cm DN6 connection set
100118	Juego de conexiones 10x1 - 15x1 a 15 cm 10x1 - 15x1 15 cm connection set
100129	Juego de conexiones 10x1 - H 3/8" a 60 cm 10x1 - F 3/8" 60 cm connection set
100136	Juego de conexiones 10x1 - H 3/8" a 45 cm 10x1 - F 3/8" 45 cm connection set
9908 0270	Conector 3/8" tubo 1/4" Fitting 3/8" pipe 1/4"
9908 0353	Juego de conexiones DN6 10x1 - H 3/8" a 60 cm 10x1 - F 3/8" 60 cm DN6 connection set
9908 0358	Conexión DN6 PEX 10x1 - H 3/8" a 80 cm 10x1 - F 3/8" 80 cm PEX DN6 connection

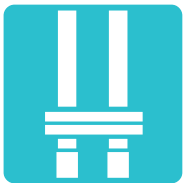

Conjunto sujeción
Fixation set

Ref.: Descripción | Description

100090	Conjunto sujeción Fixation set
100091	Conjunto sujeción 2 tornillos 2 screws fixation set
100092	Conjunto sujeción Klip Klip Fixation set
100095	Conjunto sujeción Kenjo Kenjo fixation set
100097	Conjunto sujeción fregadera extraíble Pull-out sink tap fixation set
100098	Conjunto sujeción 1/2" 1/2" Fixation set
9908 0042	Conjunto sujeción M32 M32 fixation set
9908 0047	Conjunto sujeción lavabo Oslo Oslo basin fixation set
9908 0048	Conjunto sujeción lavabo medio alto Oslo Oslo medium high basin fixation set
9908 0049	Conjunto sujeción lavabo alto Oslo Oslo high basin fixation set
9908 0050	Conjunto sujeción bidé Oslo Oslo bidet fixation set
9908 0064	Conjunto Sujeción Fixation set
9908 0264	Conjunto sujeción 61200 61200 fixation set
9908 0265	Conjunto sujeción 120 M8 120 M8 fixation set
9908 0266	Conjunto sujeción FRK FRK fixation set
9908 0271	Conjunto Sujeción para 65700 18 45 66 Fixation set for 65700 18 45 66
9908 0354	Conjunto Sujeción Inoxidable SS Fixation set
9908 0453	Conjunto sujeción llave de paso Stopcock fixation set

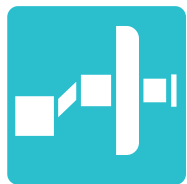

Conjunto excéntrica
Eccentric set

Ref.:	Descripción Description
100114 45	Conjunto florón y excéntricas oval Oval scutcheon and eccentric set
100125 43	Conjunto florón y excéntricas bronce Bronze scutcheon and eccentric set
100125 45	Conjunto florón y excéntricas Scutcheon and eccentric set
100126 45	Conjunto florón y excéntricas redondo D60 Round D60 scutcheon and eccentric set
100127 45	Conjunto florón y excéntricas redondo D65 Round D65 scutcheon and eccentric set
100128 45	Conjunto florón y excéntricas cuadrado Square scutcheon and eccentric set
9908 0289	Conjunto florón y excéntricas redondo D60 Negro Black Round D60 scutcheon and eccentric set
9908 0387	Cobertor fijo Fix cover



Cuerpo
Body

Ref.:	Descripción Description
51744 45	Cuerpo inversor set Oslo Oslo set diverter body
51744 41	Cuerpo inversor set Oslo Negro Black Oslo set diverter body
568113 45	Batería de baño con inversor Widespread bath mixer with diverter
568115 45	Grupo ducha empotrado 8" Built-in 8" shower mixer
568116 45	Grupo baño empotrado 8" con inversor Built-in 8" bath mixer with diverter
568120 45	Batería de lavabo Widespread wash-basin mixer
568131 45	Grupo de lavabo empotrado Built-in wash-basin mixer
568142 45	Batería de bidé con transmisión Widespread bidet mixer with transmission
568170 45	Llave de paso 1/2" Stopcock 1/2"
9908 0170	Inversor set redondo con base Round set diverter with base
5CM63110 45	Cuerpo monomando columna cuadrada Square single handle column body
5CM64111 45	Cuerpo monomando columna Koral Koral column single handle body
5CM65110 45	Cuerpo monomando columna redonda Round column single handle body
5CM65111 45	Cuerpo monomando columna Oslo Oslo column single lever mixer body
5CM65111 41	Cuerpo monomando columna Oslo Oslo column single lever mixer body
5CT63110 45	Cuerpo termostático columna Kenjo Kenjo column thermostatic mixer body
5CT65110 45	Cuerpo termostático columna Tau Tau column thermostatic mixer body
5CT65111 45	Cuerpo termostático columna Oslo Oslo column thermostatic mixer body
5CT67111 41	Cuerpo termostático columna Oslo Oslo column thermostatic mixer body
9908 0345	Racord para CT67110 26 CT67110 26 column conector
9908 0202	Racord columna Kenjo Kenjo column conector
65116 19 45 66	Monomando empotrado con inversor 2 vías 2 way Built-in single lever mixer with diverter



Placa
Tap plate

Ref.:	Descripción Description
9908 0053	Placa termostática empotrada 3 vías Built-in 2 way thermostatic mixer plate
9908 0055	Placa termostática empotrada 2 vías Built-in 3 way thermostatic mixer plate
9908 0228	Placa lavabo ovalada D35 Negra Black D35 oval basin mixer plate
9908 0341	Placa ducha empotrada Negra Black Built-in shower mixer plate
9908 0342	Placa baño/ducha empotrado Negra Black Built-in bath/shower mixer plate
PC114	Placa inversor cerámico Built-in ceramic diverter plate
PC115	Placa ducha empotrada Built-in shower mixer plate
PC116	Placa baño/ducha empotrado Built-in bath/shower mixer plate
PC117	Placa empotrada 2 vías Built-in 2 way plate
PC118	Placa empotrada 3 vías Built-in 3 way plate
PC131	Placa lavabo empotrado Built-in basin mixer plate
PK115	Placa ducha empotrada Built-in shower mixer plate
PK116	Placa baño/ducha empotrado Built-in bath/shower mixer plate
PK131	Placa lavabo caño cuadrado Square spout basin plate
PL115	Placa ducha empotrada Built-in shower mixer plate
PL116	Placa baño/ducha empotrado Built-in bath/shower mixer plate
PL131	Placa lavabo ovalada D35 D35 oval basin mixer plate
PO113	Placa inversor ovalada Diverter oval plate
PO115	Placa ovalada ducha empotrada Built-in shower mixer plate
PO117	Placa ovalada empotrada 2 vías Built-in 2 way oval plate
PO118	Placa ovalada empotrada 3 vías Built-in 3 way oval plate
PO131	Placa lavabo ovalada Oval basin plate
PR113	Placa inversor redonda Diverter round plate
PS115	Placa ducha empotrada Built-in shower mixer plate
PS116	Placa baño/ducha empotrado Built-in bath/shower mixer plate
PT113	Placa inversor cuadrada Diverter square plate
PT115	Placa ducha empotrada Built-in shower tap plate
PT116	Placa baño/ducha empotrado Built-in bath/shower mixer plate
PT117	Placa rectangular empotrada 2 vías Built-in 2 way rectangular plate
PT118	Placa rectangular inversor empotrada 3 vías Built-in 3 way rectangular plate
PT131	Placa lavabo rectangular Rectangular basin mixer plate
9908 0452	Placa llave de paso Stopcock plate
9908 0456	Placa mezclador sanitario Sanitary mixer plate
9908 0460	Placa mezclador sanitario Negro Black sanitary mixer plate



Set juntas
Gasket sets

Ref.: Descripción | Description

100019	Set de juntas inversor monomando bidé Gasket set single lever bidet diverter
9908 0063	Set juntas montura convencional Join set conventional headwork
9908 0074	Set de juntas para 61900 28 45 66 Gasket set for 61900 28 45 66
9908 0075	Set de juntas para 65900 18 45 66 Gasket set for 65900 18 45 66
9908 0152	Set de juntas serie A A series gasket set
9908 0153	Set de juntas serie B B series gasket set
9908 0154	Set de juntas serie C C series gasket set
9908 0200	Set juntas columna redonda Round column gasket set
9908 0209	Set de juntas Gasket set
9908 0210	Set juntas columna cuadrada Square column gasket set
9908 0030	Set juntas columna redonda Round column gasket set
9908 0257	Set de juntas para 65212 18 45 66 Gasket set for 65212 18 45 66
9908 0261	Set de juntas para 65219 18 45 66 Gasket set for 65219 18 45 66
9908 0263	Set de juntas para 65700 18 45 66 Gasket set for 65700 18 45 66
9908 0269	Set de juntas para 65215 40 60 66 Gasket set for 65215 40 60 66
J15	Set de juntas inversor monomando bidé Single lever bidet mixer diverter gasket set
J16	Set de juntas R16 R16 gasket set
J17	Set de juntas columna extensible Extensible column gasket set
J18	Set de juntas para 65203 18 60 66 Gasket set for 65203 18 60 66
J19	Set de juntas para 65208 18 60 66 Gasket set for 65208 18 60 66
J20	Set de juntas para 65211 18 60 66 Gasket set for 65211 18 60 67
J61	Set de juntas 61200 61200 gasket set
J65	Set de juntas R21 R21 gasket set
J67	Set de juntas 65702 18 45 66 65702 18 45 66 gasket set
9908 0350	Junta tapón V-click V-click cap gasket
J68	Set de juntas caño tubo Pipe spout gasket set
9901 0171	Set eje pedal 1342 1342 pedal axis set
9908 0371	Set de juntas para 65200 19 45 66 Gasket set for 65200 19 45 66
9908 0357	Set de juntas para 65703 18 60 66 Gasket set for 65703 18 60 66
9908 0394	Set de juntas para FRV61208 Gasket set for FRV61208

Ref.: Descripción | Description

9908 0155	Muelle click L25 L25 click spring
9908 0156	Muelle click L35 L35 click spring
9908 0157	Muelle click L38 L38 click spring



Muelles
Springs



Set retenciones
Check valve sets

Ref.:	Descripción Description
9908 0011	Retenciones termostáticas murales Wall thermostatic mixer check valve
9908 0012	Retenciones termostáticas empotradas Built-in tap thermostatic mixer check valve
9908 0236	Set de retenciones para termostáticas Oslo Oslo thermostatic mixer check valve set



Tapones
Caps

Ref.:	Descripción Description
9908 0162	Tapón V-Click "Luxe" Cap V-Click "Luxe"
9908 0163	Tapon V-Click Luxe Bronce Cap V-Click Luxe Bronze
9908 0164	Tapón V-Click Kenjo Kenjo V-click cap
9908 0165	Tapón V-click 1 1/4" 1 1/4" V-click cap
9908 0166	Tapón V-click 1 1/2" 1 1/2" V-click cap
9908 0347	Tapón V-click 1 1/2" Bronce Bronze 1 1/2" Cap V-click
9908 0348	Tapon V-Click "Luxe Negro" Cap V-Click "Luxe Black"
9908 0167	Tapón V-click 1 1/4" 1 1/4" V-click cap
9908 0168	Tapón V-click 1 1/4" 1 1/4" V-click cap

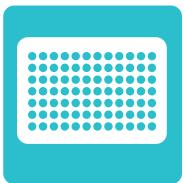

Filtros
Filter

Ref.:	Descripción Description
FT91	Filtro ultrafiltración Ultrafiltration filter
FT92	Filtro de clorador Dechlorinator filter

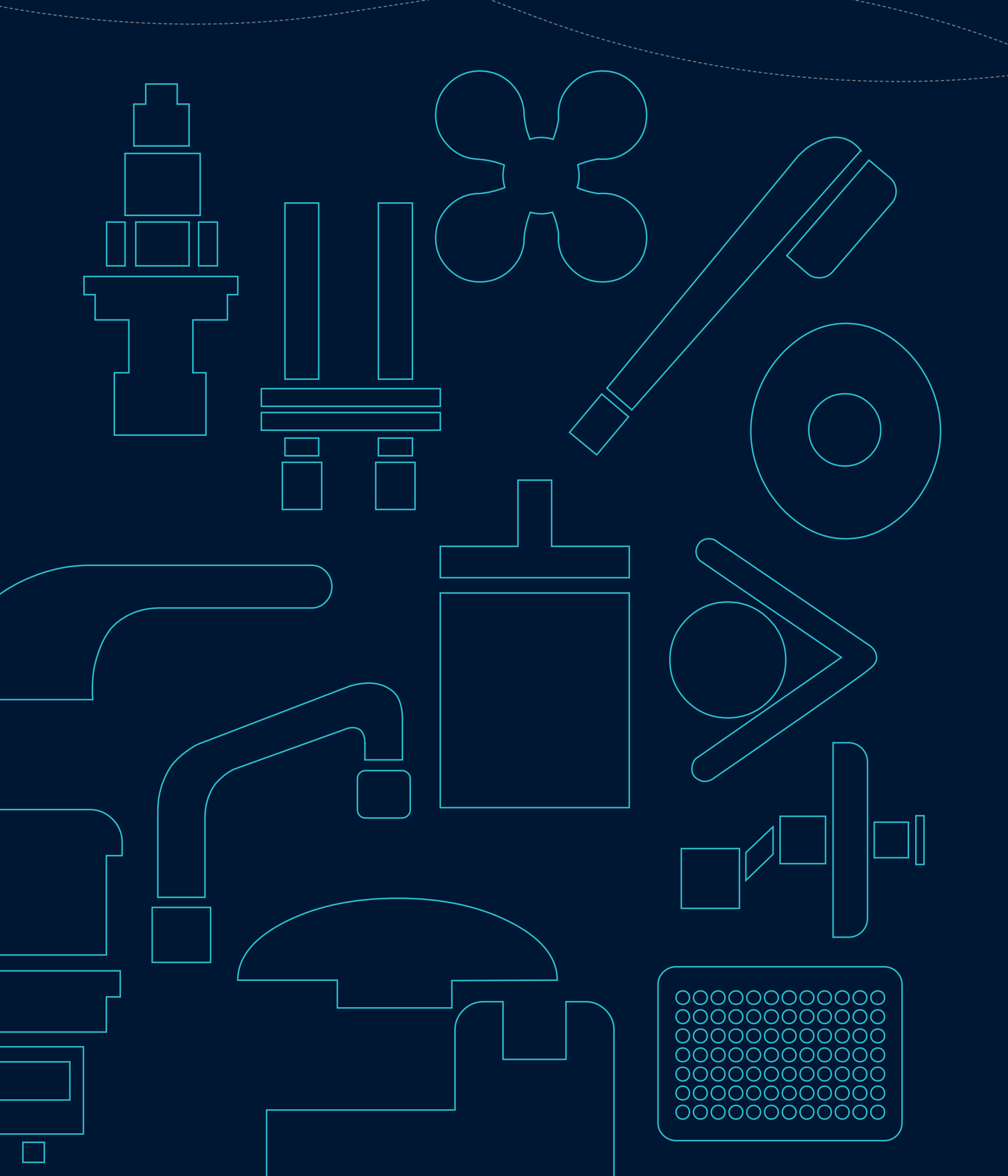

Información técnica

Technical Information

Consulta la ficha técnica de nuestros productos

Busque la referencia del artículo y encontrará toda la información técnica necesaria referente al producto.

Consult data sheet of our product

Locate the reference article and find all the technical information regarding the product.

Símbolos | Symbols



Maneta
Handle



Volantes
Handles



Florón
Scutcheon



Duchas
Shower



Flexo
Flexible hose



Soporte ducha fijos
Fixed shower holders



Soportes ducha
deslizantes
Sliding shower
holders



Soporte
Holder



Caño
Spout



Aireador
Aerator



Cartucho
Cartridge



Montura
Headwork



Inversor
Diverter



Conexión flexible
Connection set



Conjunto sujección
Fixation set



Conjunto excéntrica
Eccentric set



Cuerpo
Body



Placa
Tap plate



Set juntas
Gasket sets



Muelles
Springs



Set retenciones
Check valve sets



Tapones
Caps

Baño Bathroom

serie Koral | Acabado cromado | Chromed finish

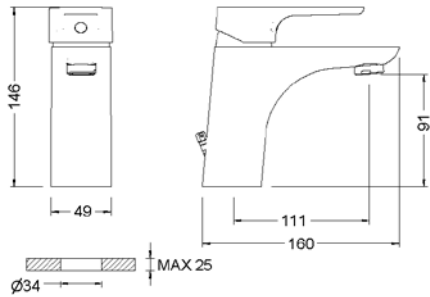

Ref.: 64130 32 45 66
Monomando de lavabo
 Single lever wash-basin mixer
Box: 1 | Carton: 20 | Pallet: 360

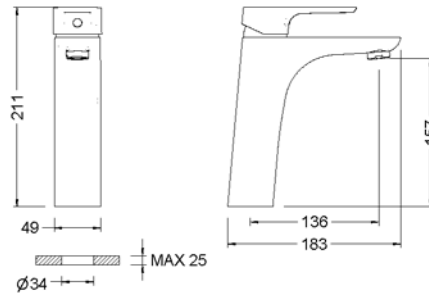

Ref.: 64134 32 45 66
Monomando de lavabo medio alto
 Medium height single lever wash-basin mixer
Box: 1 | Carton: 10 | Pallet: 180

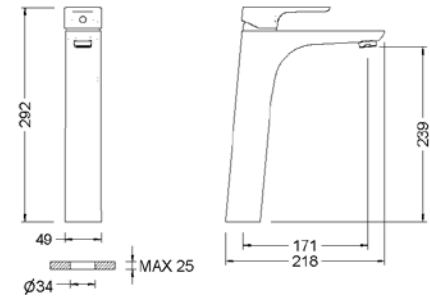

Ref.: 64136 32 45 66
Monomando de lavabo alto
 High single lever wash-basin mixer
Box: 1 | Carton: 6 | Pallet: 108

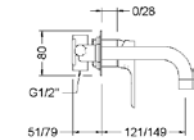

Ref.: 64131 32 45 66
Monomando de lavabo empotrado caño 16 cm
 Built-in wash-basin mixer 16 cm spout
Box: 1 | Carton: 6 | Pallet: 144

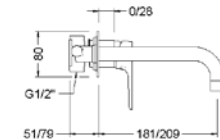

Ref.: 64132 32 45 66
Monomando de lavabo empotrado caño 22 cm
 Built-in wash-basin mixer 22 cm spout
Box: 1 | Carton: 6 | Pallet: 144

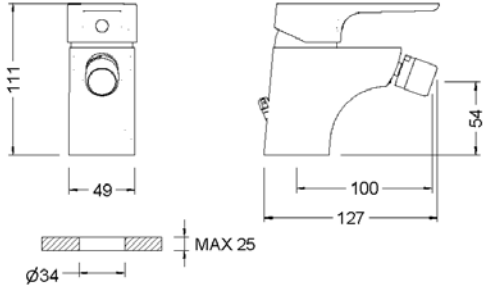

Ref.: 64140 32 45 66
Monomando de bidé
 Single lever bidet mixer
Box: 1 | Carton: 8 | Pallet: 480

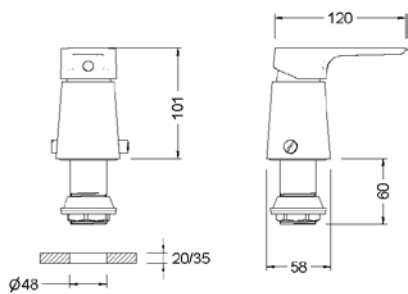

Ref.: 64142 32 45 66
Monomando de bidé con transmisión
 Single lever bidet mixer with diverter
Box: 1 | Carton: 12 | Pallet: 288

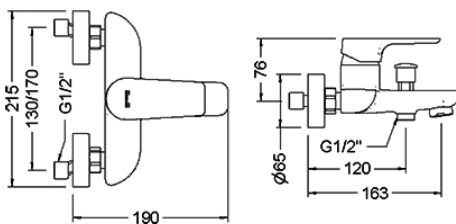

Ref.: 64100 32 45 66
Monomando de baño con kit
 Single lever bath mixer with kit
Box: 1 | Carton: 8 | Pallet: 96

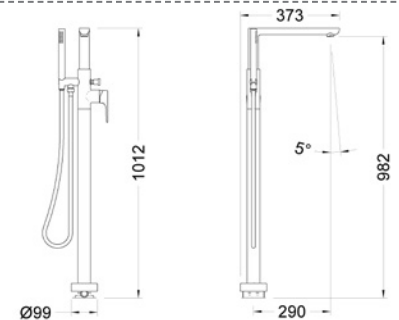
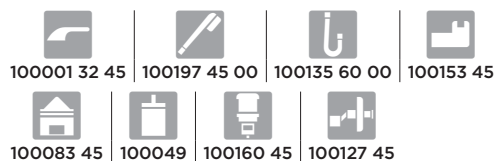

Ref.: 64119 32 45 66
Monomando de pie para bañera
 Floor single lever mixer for bath



serie Koral | Acabado cromado | Chromed finish.

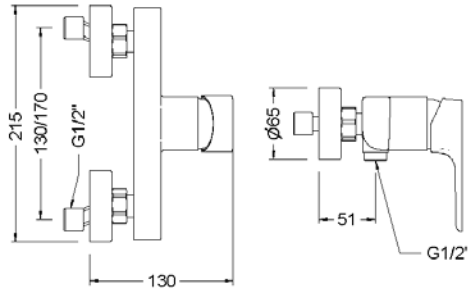

Ref.: 64110 32 45 66
Monomando de ducha con kit
 Single lever shower mixer with kit

Box: 1 | Carton: 8 | Pallet: 96

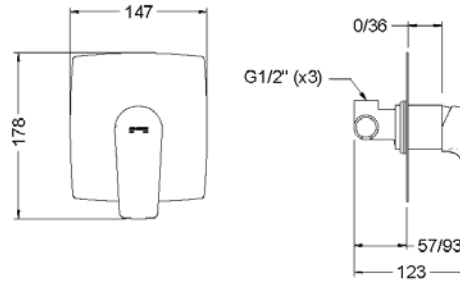
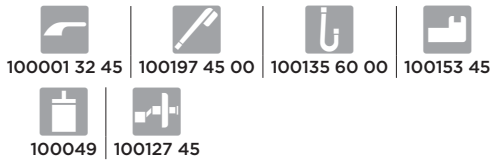

Ref.: 64115 32 45 66
Monomando de ducha empotrado
 Built-in single lever shower mixer

Box: 1 | Carton: 12 | Pallet: 216

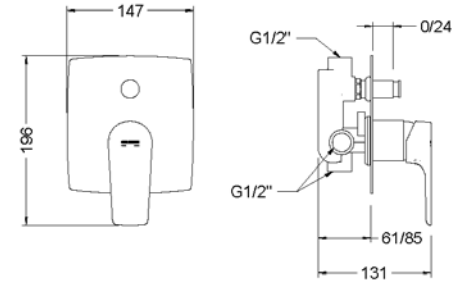

Ref.: 64116 32 45 66
Monomando empotrado con inversor 2 vías
 2 way Built-in single lever mixer with diverter

Box: 1 | Carton: 12 | Pallet: 216

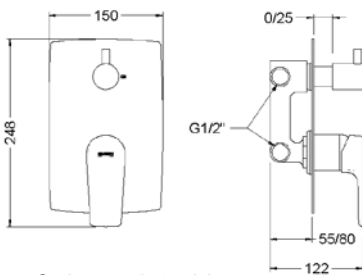

Ref.: 64117 32 45 66
Monomando empotrado con inversor cerámico 2 vías
 Built-in single lever mixer with 2-way ceramic diverter

Box: 1 | Carton: 6 | Pallet: 108

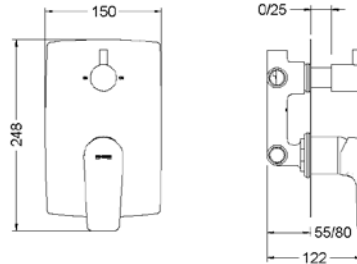
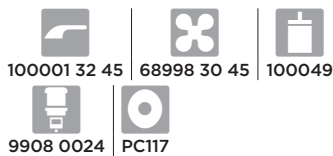

Ref.: 64118 32 45 66
Monomando empotrado con inversor cerámico 3 vías
 Built-in single lever mixer with 3-way ceramic diverter

Box: 1 | Carton: 6 | Pallet: 108

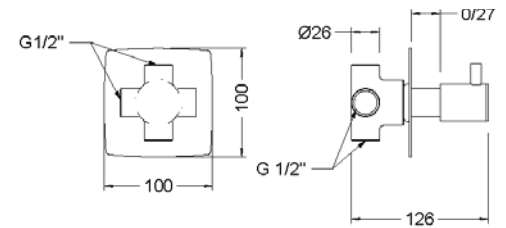
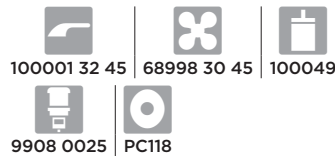

Ref.: 64114 30 45 66
Inversor cerámico 3 vías empotrado
 Built-in 3-way ceramic diverter

Box: 1 | Carton: 8 | Pallet: 288



serie Kode | Acabado cromado | Chromed finish

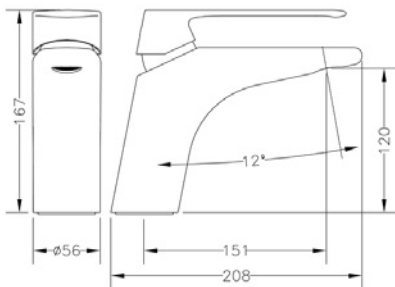

Ref.: 62130 08 45 66
Monomando de lavabo
 Single lever wash-basin mixer

Box: 1 | Carton: 8 | Pallet: 192

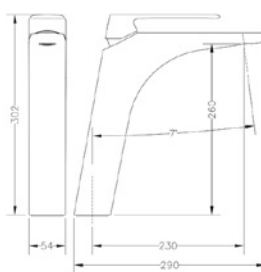
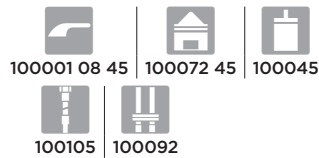

Ref.: 62136 08 45 66
Monomando de lavabo alto
 High single lever wash-basin mixer

Box: 1 | Carton: 4 | Pallet: 96

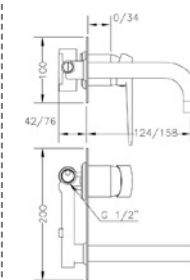
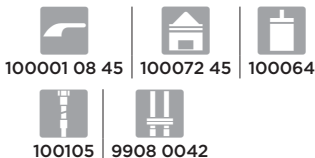

Ref.: 62131 31 45 66
Monomando de lavabo empotrado caño 16 cm
 Built-in wash-basin mixer 16 cm spout

Box: 1 | Carton: 6 | Pallet: 144



serie Kode | Acabado cromado | Chromed finish

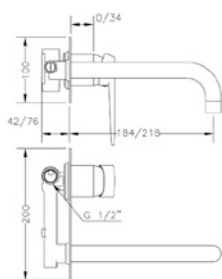

Ref.: 62132 31 45 66
Monomando de lavabo empotrado caño 22 cm
 Built-in wash-basin mixer 22 cm spout

Box: 1 | Carton: 6 | Pallet: 144

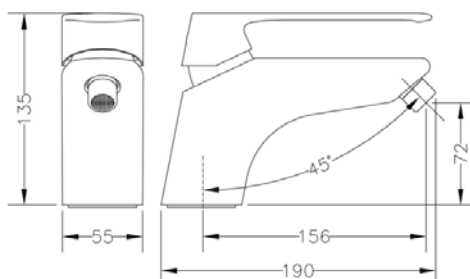

Ref.: 62140 08 45 66
Monomando de bidé
 Single lever bidet mixer

Box: 1 | Carton: 8 | Pallet: 192

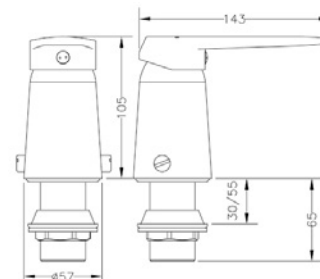

Ref.: 62142 31 45 66
Monomando de bidé con transmisión
 Single lever bidet mixer with diverter

Box: 1 | Carton: 12 | Pallet: 216

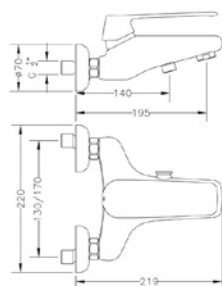

Ref.: 62100 08 45 67
Monomando de baño sin kit
 Single lever bath mixer without kit

Box: 1 | Carton: 6 | Pallet: 144

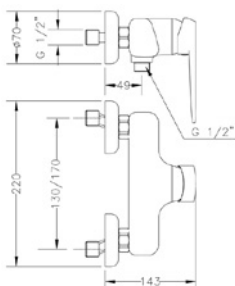
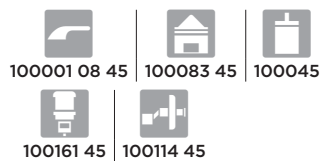

Ref.: 62110 31 45 67
Monomando de ducha sin kit
 Single lever shower mixer without kit

Box: 1 | Carton: 6 | Pallet: 144

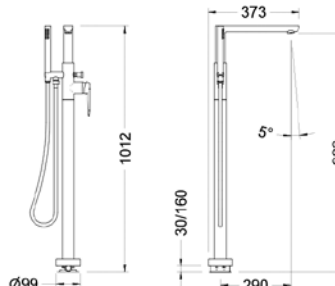

Ref.: 62119 31 45 66
Monomando de pie para bañera Kode
 Kode Floor single lever mixer for bath

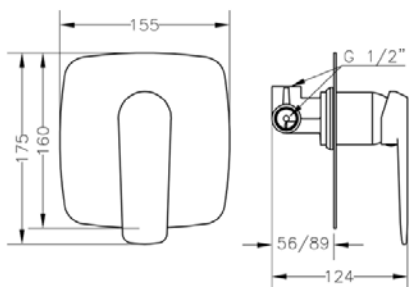
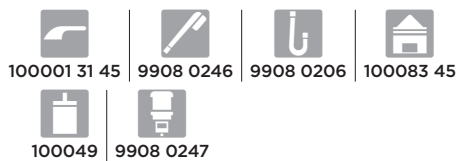

Ref.: 62115 31 45 66
Monomando de ducha empotrado
 Built-in single lever shower mixer

Box: 1 | Carton: 8 | Pallet: 192

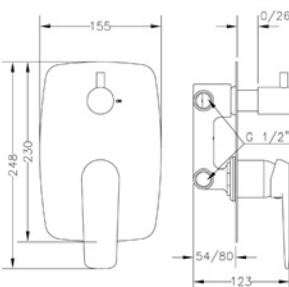

Ref.: 62117 31 45 66
Monomando empotrado con inversor cerámico 2 vías
 Built-in single lever mixer with 2 way ceramic diverter

Box: 1 | Carton: 6 | Pallet: 108

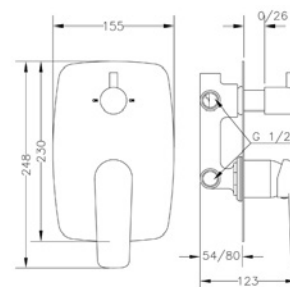
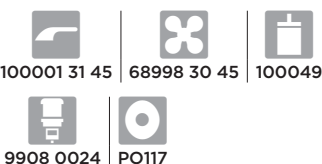

Ref.: 62118 31 45 66
Monomando empotrado con inversor cerámico 3 vías
 Built-in single lever mixer with 3 way ceramic diverter

Box: 1 | Carton: 6 | Pallet: 108



serie Kode | Acabado cromado | Chromed finish

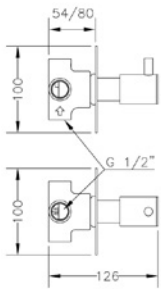

Ref.: 62114 30 45 66
Inversor cerámico 3 vías empotrado con placa ovalada
 Built-in 3 way ceramic diverter with oval plate

Box: 1 | Carton: 8 | Pallet: 384



serie Oslo | Acabado cromado | Chromed finish

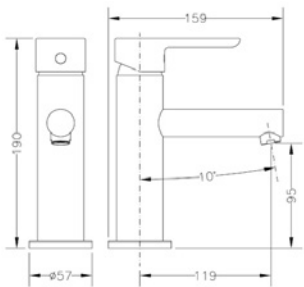

Ref.: 65130 19 45 66
Monomando de lavabo
 Single lever wash-basin mixer

Box: 1 | Carton: 12 | Pallet: 192

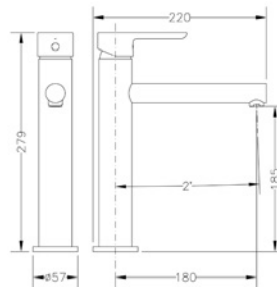

Ref.: 65134 19 45 66
Monomando de lavabo medio alto
 Medium height single lever wash-basin mixer

Box: 1 | Carton: 10 | Pallet: 80

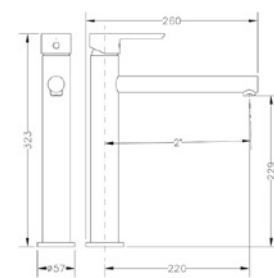

Ref.: 65136 19 45 66
Monomando de lavabo alto
 High single lever wash-basin mixer

Box: 1 | Carton: 10 | Pallet: 80

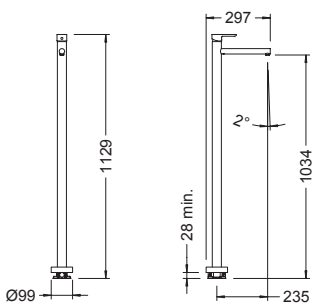

Ref.: 65139 19 45 66
Monomando de pie para lavabo
 Single-lever basin foot

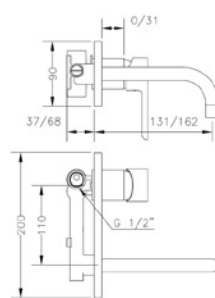

Ref.: 65131 19 45 66
Monomando de lavabo empotrado caño 16 cm
 Built-in wash-basin mixer 16 cm spout

Box: 1 | Carton: 6 | Pallet: 144

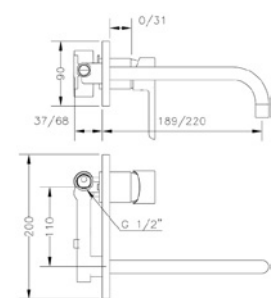

Ref.: 65132 19 45 66
Monomando de lavabo empotrado caño 22 cm
 Built-in wash-basin mixer 22 cm spout

Box: 1 | Carton: 6 | Pallet: 144



serie Oslo | Acabado cromado | Chromed finish

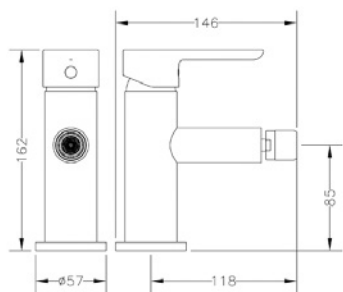

Ref.: 65140 19 45 66
Monomando de bidé
 Single lever bidet mixer

Box: 1 | Carton: 12 | Pallet: 192

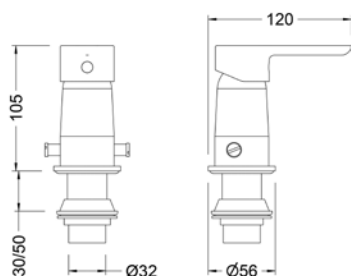

Ref.: 65142 19 45 66
Monomando de bidé con transmisión
 Single lever bidet mixer with diverter

Box: 1 | Carton: 12 | Pallet: 288

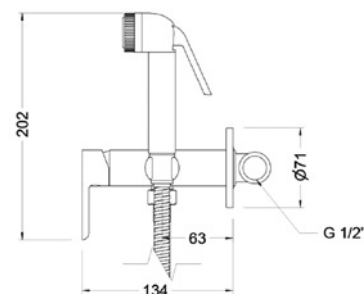

Ref.: 65144 19 45 66
Set mezclador sanitario de ducha con soporte
 Sanitary shower mixer set with support

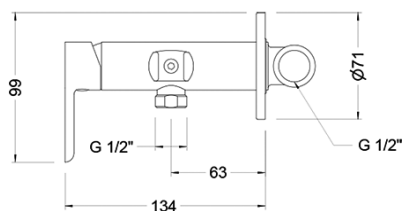

Ref.: 65144 19 45 67
Mezclador sanitario de ducha con soporte
 Sanitary shower mixer with support

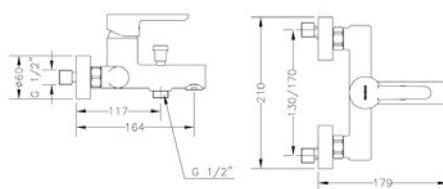

Ref.: 65100 19 45 66
Monomando de baño con kit
 Single lever bath mixer with kit

Box: 1 | Carton: 8 | Pallet: 96

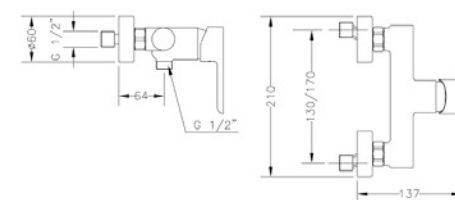

Ref.: 65110 19 45 66
Monomando de ducha con kit
 Single lever shower mixer with kit

Box: 1 | Carton: 8 | Pallet: 96

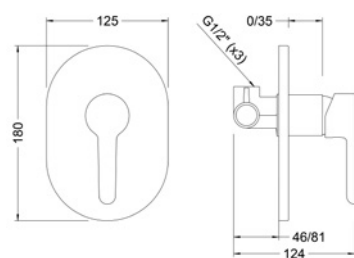
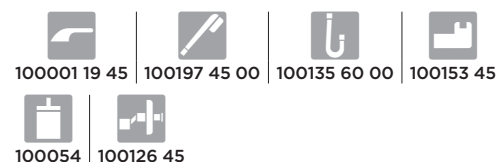

Ref.: 65115 19 45 66
Monomando de ducha empotrado
 Built-in single lever shower mixer

Box: 1 | Carton: 12 | Pallet: 324

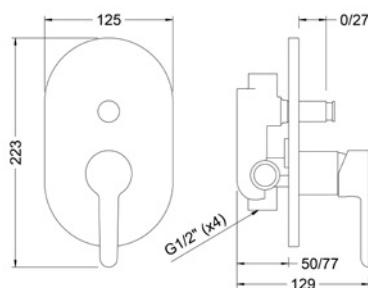

Ref.: 65116 19 45 66
Monomando empotrado con inversor 2 vías
 2 way Built-in single lever mixer with diverter

Box: 1 | Carton: 12 | Pallet: 324

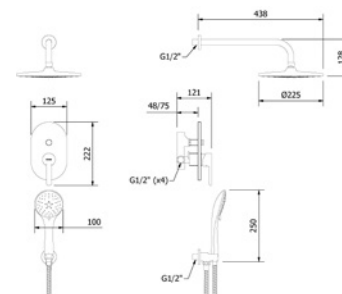

Ref.: ST116 19
Kit de ducha empotrado Oslo
 Oslo Built-in shower kit

Box: 1 | Carton: 2 | Pallet: 54



serie Oslo Black | Black Oslo

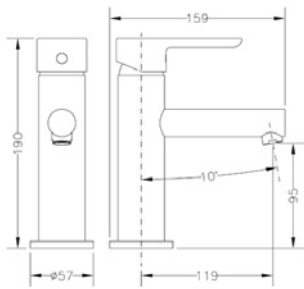

Ref.: 65130 19 41 66
Monomando de lavabo
 Single lever wash-basin mixer

Box: 1 | Carton: 12 | Pallet: 192

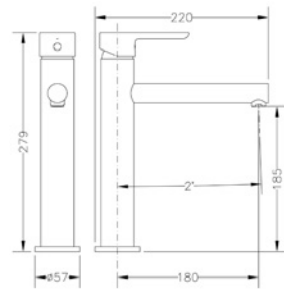

Ref.: 65134 19 41 66
Monomando de lavabo medio alto
 Medium height single lever wash-basin mixer

Box: 1 | Carton: 10 | Pallet: 80

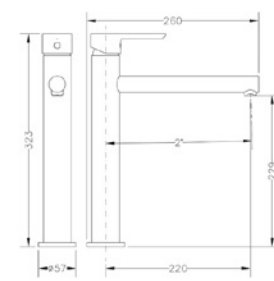

Ref.: 65136 19 45 66
Monomando de lavabo alto
 High single lever wash-basin mixer

Box: 1 | Carton: 10 | Pallet: 80

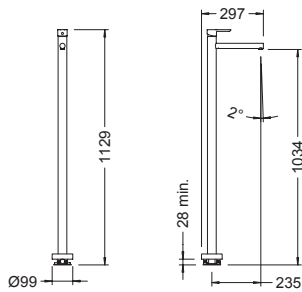

Ref.: 65139 19 41 66
Monomando de pie para lavabo negro
 Black single-lever basin foot

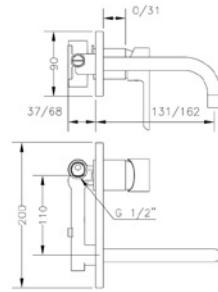

Ref.: 65131 19 41 66
Monomando de lavabo empotrado caño 16cm
 Built-in wash-basin mixer 16 cm spout

Box: 1 | Carton: 6 | Pallet: 144

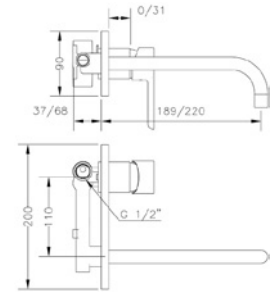

Ref.: 65132 19 41 66
Monomando de lavabo empotrado caño 22cm
 Built-in wash-basin mixer 22 cm spout

Box: 1 | Carton: 6 | Pallet: 144

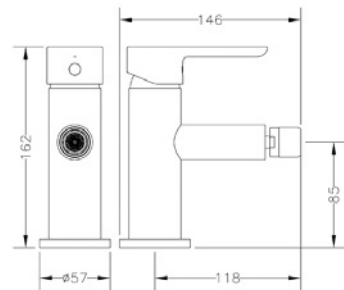
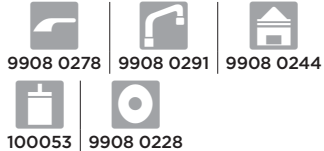

Ref.: 65140 19 41 66
Monomando de bidé
 Single lever bidet mixer

Box: 1 | Carton: 12 | Pallet: 192

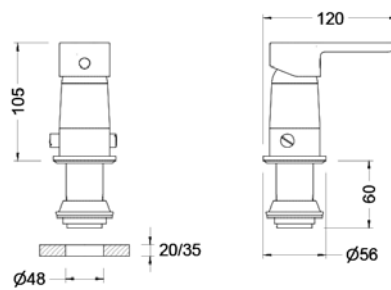

Ref.: 65142 19 41 66
Monomando de bidé con transmisión
 Single lever bidet mixer with diverter

Box: 1 | Carton: 12 | Pallet: 288

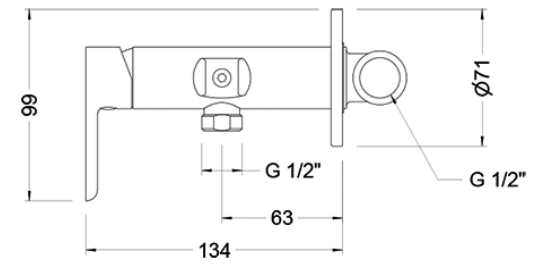

Ref.: 65144 19 41 67
Mezclador sanitario de ducha con soporte Negro
 Black Sanitary shower mixer with support



serie Oslo Black | Black Oslo

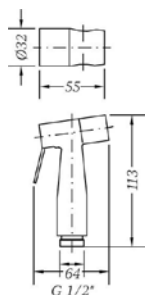

Ref.: 100694 41
Kit ducha sanitaria Negro
 Black Sanitary shower kit

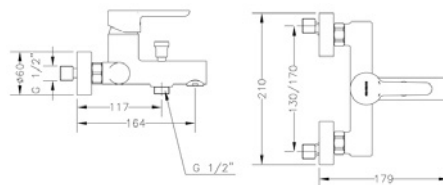

Ref.: 65100 19 41 66
Monomando de baño con kit
 Single lever bath mixer with kit

Box: 1 | Carton: 8 | Pallet: 96

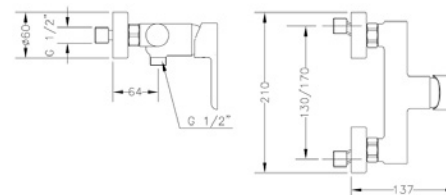

Ref.: 65110 19 41 66
Monomando de ducha con kit
 Single lever shower mixer with kit

Box: 1 | Carton: 8 | Pallet: 96

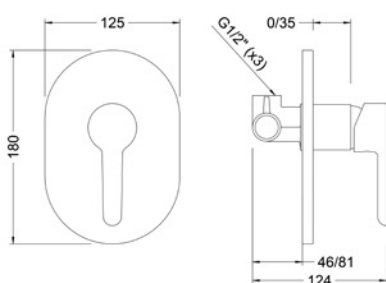

Ref.: 65115 19 41 66
Monomando empotrado con inversor 2 vías
 2 way Built-in single lever mixer with diverter

Box: 1 | Carton: 12 | Pallet: 324

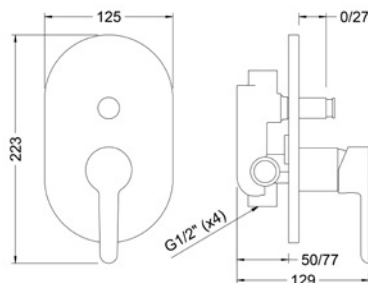

Ref.: 65116 19 41 66
Monomando de baño empotrado con inversor
 Built-in single lever bath mixer with diverter

Box: 1 | Carton: 12 | Pallet: 216



serie Klip | Acabado cromado | Chromed finish

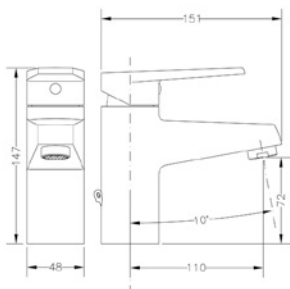

Ref.: 64130 16 45 66
Monomando de lavabo
 Single lever wash-basin mixer

Box: 1 | Carton: 20 | Pallet: 360

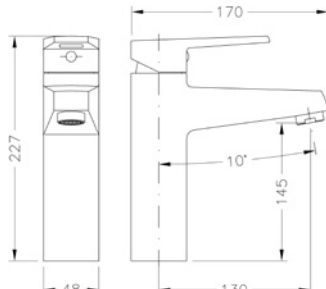

Ref.: 64134 16 45 66
Monomando de lavabo medio alto
 Medium height single lever wash-basin mixer

Box: 1 | Carton: 10 | Pallet: 180

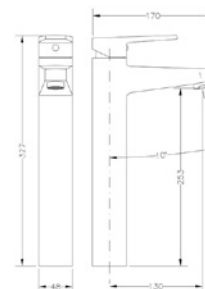

Ref.: 64136 16 45 66
Monomando de lavabo alto
 High single lever wash-basin mixer

Box: 1 | Carton: 6 | Pallet: 108



serie Klip | Acabado cromado | Chromed finish

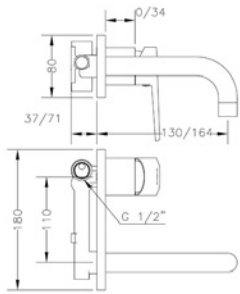

Ref.: 64131 16 45 66
Monomando de lavabo empotrado caño 16 cm
 Built-in wash-basin mixer 16 cm spout

Box: 1 | Carton: 6 | Pallet: 144

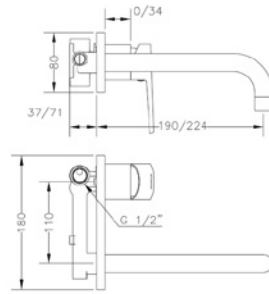

Ref.: 64132 16 45 66
Monomando de lavabo empotrado caño 22 cm
 Built-in wash-basin mixer 22 cm spout

Box: 1 | Carton: 6 | Pallet: 144

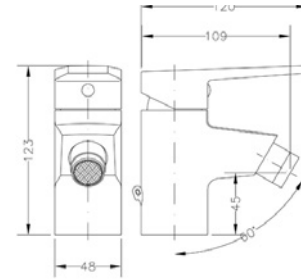

Ref.: 64140 16 45 66
Monomando de bidé
 Single lever bidet mixer

Box: 1 | Carton: 8 | Pallet: 480

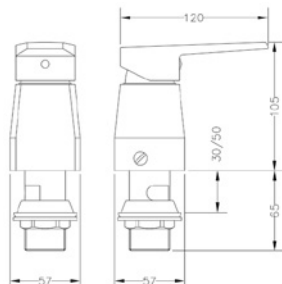

Ref.: 64142 16 45 66
Monomando de bidé con transmisión
 Single lever bidet mixer with diverter

Box: 1 | Carton: 12 | Pallet: 216

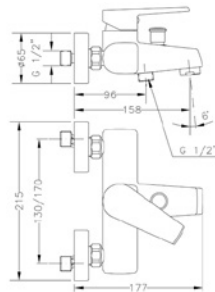

Ref.: 64100 16 45 66
Monomando de baño con kit
 Single lever bath mixer with kit

Box: 1 | Carton: 8 | Pallet: 96

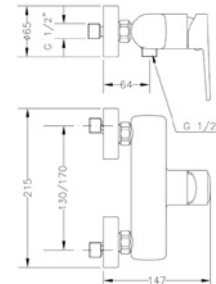
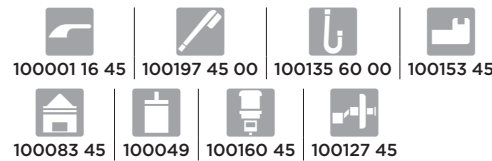

Ref.: 64110 16 45 66
Monomando de ducha con kit
 Single lever shower mixer with kit

Box: 1 | Carton: 8 | Pallet: 96

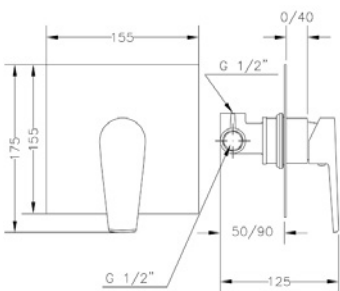
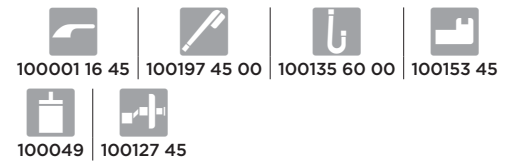

Ref.: 64115 16 45 66
Monomando de ducha empotrado
 Built-in single lever shower mixer

Box: 1 | Carton: 12 | Pallet: 216

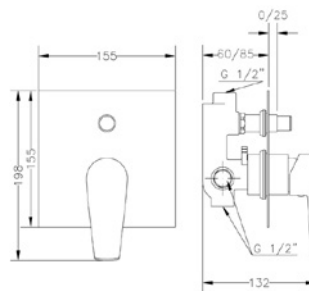

Ref.: 64116 16 45 66
Monomando empotrado con inversor 2 vías
 2 way Built-in single lever mixer with diverter

Box: 1 | Carton: 12 | Pallet: 216

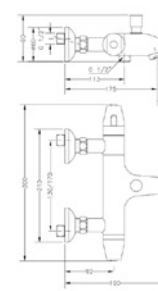

Ref.: 67103 14 45 67
Termostática baño
 Thermostatic bath mixer

Box: 1 | Carton: 6 | Pallet: 108

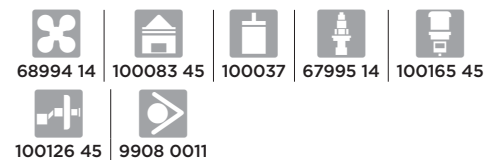

serie Klip | Acabado cromado | Chromed finish

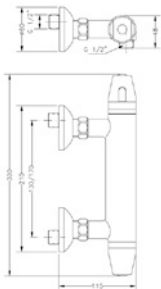

Ref.: 67104 14 45 67
Termostática ducha
 Thermostatic shower mixer

Box: 1 | Carton: 12 | Pallet: 288



serie Kelogic | Acabado cromado | Chromed finish

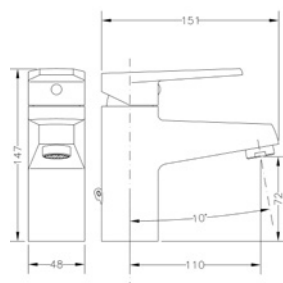

Ref.: 64130 04 45 66
Monomando de lavabo apertura en frío
 Single lever wash-basin mixer cold start

Box: 1 | Carton: 20 | Pallet: 360

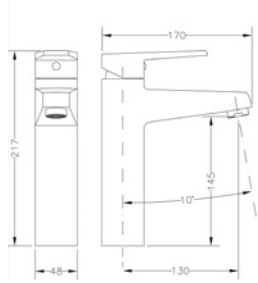

Ref.: 64134 04 45 66
Monomando lavabo medio alto apertura en frío
 Medium height single lever wash-basin mixer cold start

Box: 1 | Carton: 10 | Pallet: 180

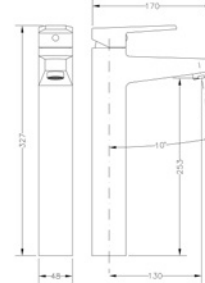

Ref.: 64136 04 45 66
Monomando lavabo alto apertura en frío
 High single lever wash-basin mixer cold start

Box: 1 | Carton: 6 | Pallet: 108

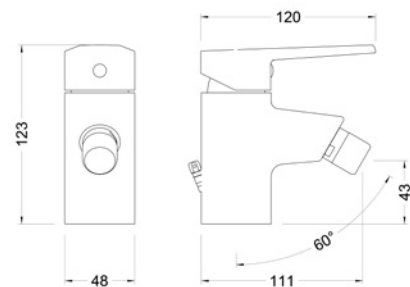

Ref.: 64140 04 45 66
Monomando bidé apertura en frío
 Single lever bidet mixer cold start

Box: 1 | Carton: 8 | Pallet: 480

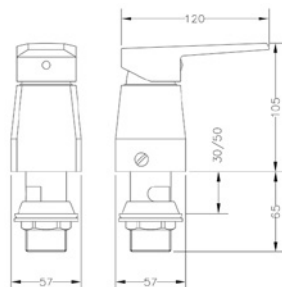

Ref.: 64142 16 45 66
Monomando de bidé con transmisión
 Single lever bidet mixer with diverter

Box: 1 | Carton: 12 | Pallet: 216

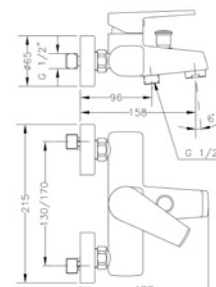

Ref.: 64100 04 45 66
Monomando de baño con kit
 Single lever bath mixer with kit

Box: 1 | Carton: 8 | Pallet: 128



serie Kelogic | Acabado cromado | Chromed finish

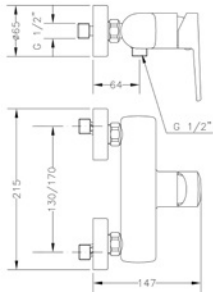

Ref.: 64110 04 45 66
Monomando de ducha con kit
 Single lever shower mixer with kit

Box: 1 | Carton: 8 | Pallet: 96

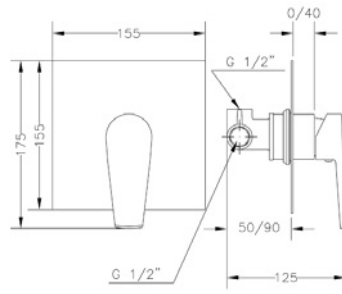
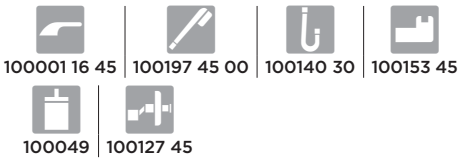

Ref.: 64115 16 45 66
Monomando de ducha empotrado
 Built-in single lever shower mixer

Box: 1 | Carton: 12 | Pallet: 216

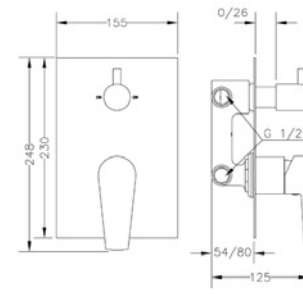

Ref.: 64117 04 45 66
Monomando empotrado con inversor cerámico 2 vías
 Built-in single lever mixer with 2-way ceramic diverter

Box: 1 | Carton: 6 | Pallet: 108

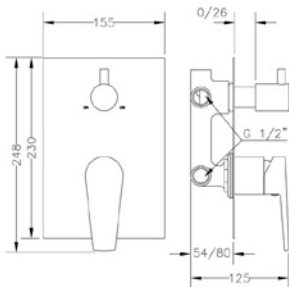

Ref.: 64118 04 45 66
Monomando empotrado con inversor cerámico 3 vías
 Built-in single handle mixer with 3-way ceramic diverter

Box: 1 | Carton: 6 | Pallet: 108

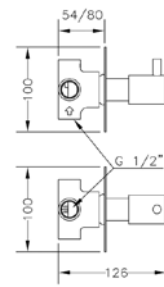

Ref.: 65114 30 45 66
Inversor cerámico 3 vías empotrado con placa cuadrada
 Built-in 3-way ceramic diverter with square plate

Box: 1 | Carton: 8 | Pallet: 288



serie Tau | Acabado cromado. Cartucho 40 | Chromed finish. Cartridge 40

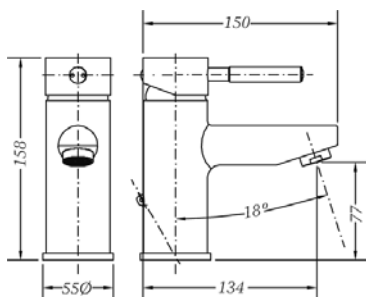

Ref.: 65135 18 45 66
Monomando de lavabo
 Single lever wash-basin tap

Box: 1 | Carton: 12 | Pallet: 216

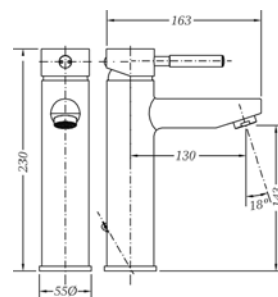

Ref.: 65134 18 45 66
Monomando de lavabo medio alto
 Medium height single lever wash-basin mixer

Box: 1 | Carton: 10 | Pallet: 180

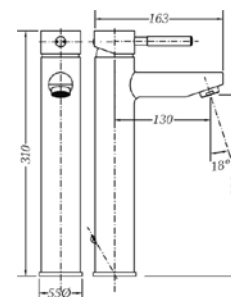

Ref.: 65136 18 45 66
Monomando de lavabo alto
 High single lever wash-basin mixer

Box: 1 | Carton: 6 | Pallet: 108



serie Tau | Acabado cromado | Chromed finish

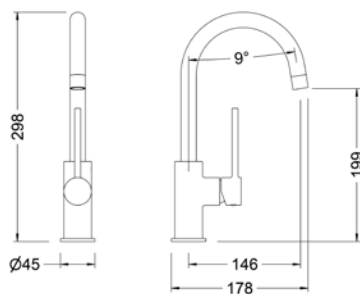

Ref.: 65138 18 45 66
Monomando de lavabo apertura en frío
 Single lever wash-basin tap cold start

Box: 1 | Carton: 10 | Pallet: 180

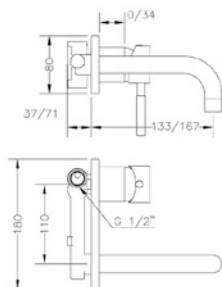
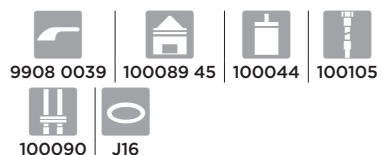

Ref.: 65131 18 45 66
Monomando de lavabo empotrado caño 16 cm
 Built-in wash-basin mixer 16 cm spout

Box: 1 | Carton: 6 | Pallet: 108

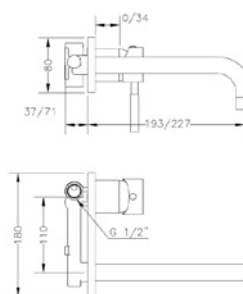

Ref.: 65132 18 45 66
Monomando de lavabo empotrado caño 22 cm
 Built-in wash-basin mixer 22 cm spout

Box: 1 | Carton: 6 | Pallet: 144

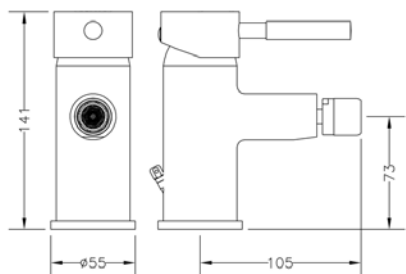

Ref.: 65145 18 45 66
Monomando de bidé
 Single lever bidet mixer

Box: 1 | Carton: 8 | Pallet: 384

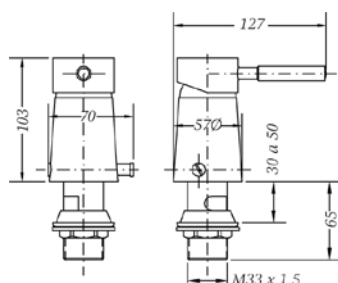

Ref.: 65142 18 45 66
Monomando de bidé con transmisión
 Single lever bidet mixer with diverter

Box: 1 | Carton: 12 | Pallet: 288

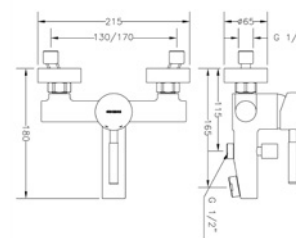

Ref.: 65100 18 45 66
Monomando de baño con kit
 Single lever bath mixer with kit

Box: 1 | Carton: 6 | Pallet: 108

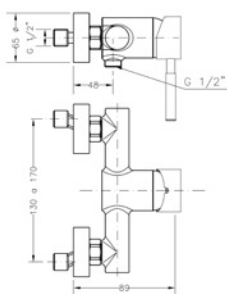

Ref.: 65110 18 45 66
Monomando de ducha con kit
 Single lever shower mixer with kit

Box: 1 | Carton: 6 | Pallet: 108

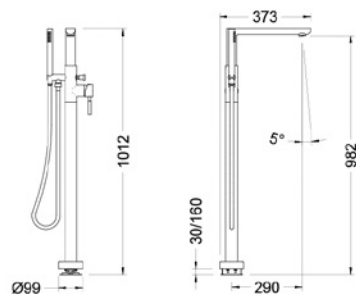

Ref.: 65119 18 45 66
Monomando de pie para bañera Tau
 Tau Floor single lever mixer for bath

Box: 1 | Carton: 2 | Pallet: 12

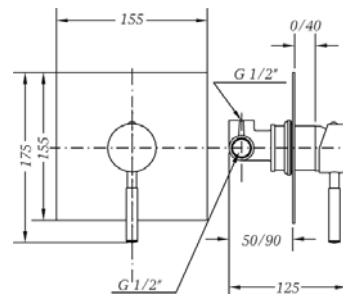

Ref.: 65115 18 45 66
Monomando de ducha empotrado
 Built-in single lever shower mixer

Box: 1 | Carton: 12 | Pallet: 216



serie Tau | Acabado cromado | Chromed finish

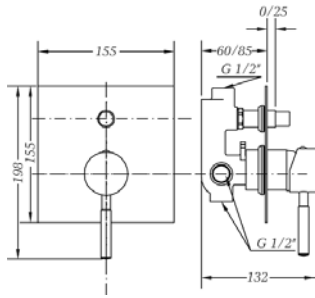

Ref.: 65116 18 45 66
Monomando empotrado con inversor 2 vías
 2 way Built-in single lever mixer with diverter
Box: 1 | Carton: 12 | Pallet: 216



100001 18 45 | 100049 | 100162 45 | PT116

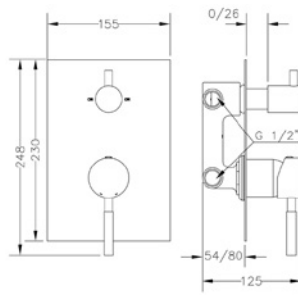

Ref.: 65117 18 45 66
Monomando empotrado con inversor cerámico 2 vías
 Built-in single lever mixer with 2-way ceramic diverter
Box: 1 | Carton: 6 | Pallet: 108



100001 18 45 | 68998 30 45 | 100049 | 9908 0024 | PT117

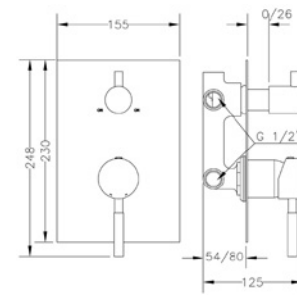

Ref.: 65118 18 45 66
Monomando empotrado con inversor cerámico 3 vías
 Built-in single lever mixer with 3-way ceramic diverter
Box: 1 | Carton: 6 | Pallet: 108



100001 18 45 | 68998 30 45 | 100049 | 9908 0025 | PT118

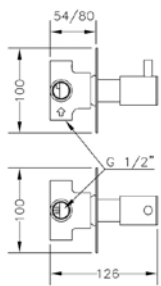

Ref.: 65114 30 45 66
Inversor cerámico 3 vías empotrado con placa cuadrada
 Built-in 3-way ceramic diverter with square plate

Box: 1 | Carton: 8 | Pallet: 288



68998 30 45 | 9908 0025 | PT113

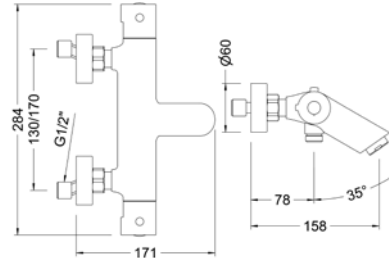

Ref.: 67102 14 45 67
Termostática baño
 Thermostatic bath mixer

Box: 1 | Carton: 6 | Pallet: 144



68991 14 | 100083 45 | 100037 | 100069 | 100126 45



9908 0011

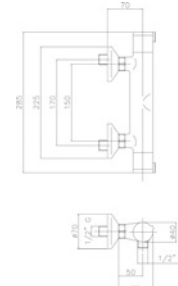

Ref.: 67112 14 45 67
Termostática ducha
 Thermostatic shower mixer

Box: 1 | Carton: 12 | Pallet: 288



68991 14 | 100037 | 67995 14 | 100126 45 | 9908 0011

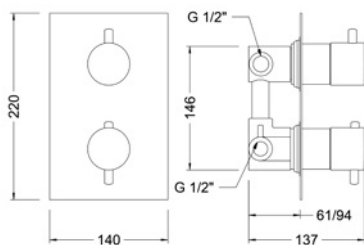

Ref.: 64114 14 45 67
Termostática empotrada 2 vías
 Built-in 2-way thermostatic mixer

Box: 1 | Carton: 4 | Pallet: 72

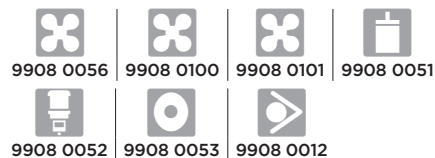

9908 0056 | 9908 0100 | 9908 0101 | 9908 0051
 9908 0052 | 9908 0053 | 9908 0012

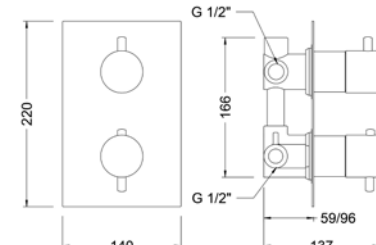

Ref.: 64111 14 45 67
Termostática empotrada 3 vías
 Built-in 3-way thermostatic

Box: 1 | Carton: 4 | Pallet: 72

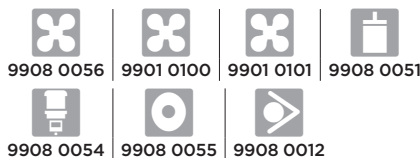

9908 0056 | 9901 0100 | 9901 0101 | 9908 0051
 9908 0054 | 9908 0055 | 9908 0012

serie Tau 2 | Acabado cromado | Chromed finish

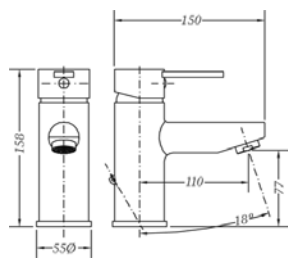

Ref.: 65135 29 45 66
Monomando de lavabo
 Single lever wash-basin mixer

Box: 1 | Carton: 12 | Pallet: 216

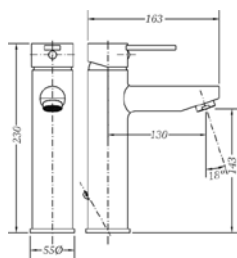

Ref.: 65134 29 45 66
Monomando de lavabo medio alto
 Medium height single lever wash-basin mixer

Box: 1 | Carton: 10 | Pallet: 180

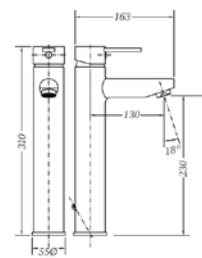

Ref.: 65136 29 45 66
Monomando de lavabo alto
 High single lever wash-basin mixer

Box: 1 | Carton: 6 | Pallet: 108

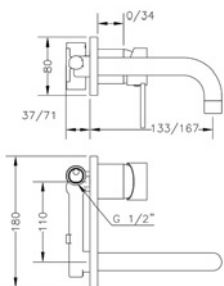

Ref.: 65131 29 45 66
Monomando de lavabo empotrado caño 16 cm
 Built-in wash-basin mixer 16 cm spout

Box: 1 | Carton: 6 | Pallet: 144

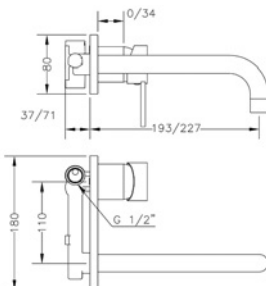

Ref.: 65132 29 45 66
Monomando de lavabo empotrado caño 22 cm
 Built-in wash-basin mixer 22 cm spout

Box: 1 | Carton: 6 | Pallet: 144

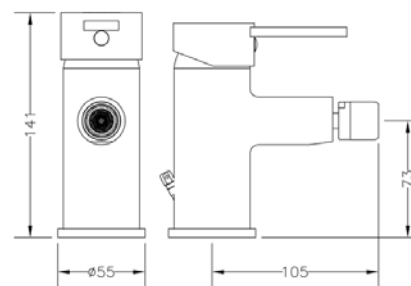

Ref.: 65145 29 45 66
Monomando de bidé
 Single lever bidet mixer

Box: 1 | Carton: 8 | Pallet: 384

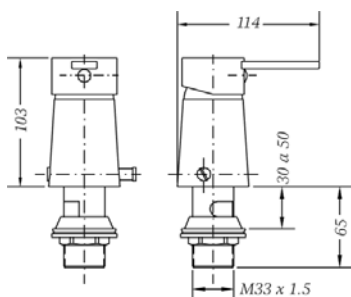

Ref.: 65142 29 45 66
Monomando de bidé con transmisión
 Single lever bidet mixer with diverter

Box: 1 | Carton: 12 | Pallet: 288

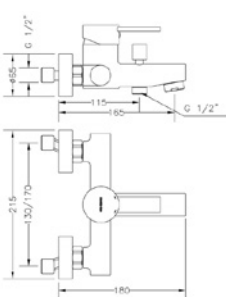

Ref.: 65100 29 45 66
Monomando de baño con kit
 Single lever bath mixer with kit

Box: 1 | Carton: 6 | Pallet: 108

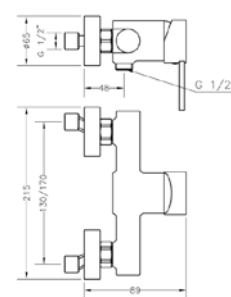
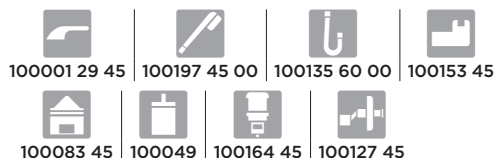

Ref.: 65110 29 45 66
Monomando de ducha con kit
 Single lever shower mixer with kit

Box: 1 | Carton: 6 | Pallet: 108

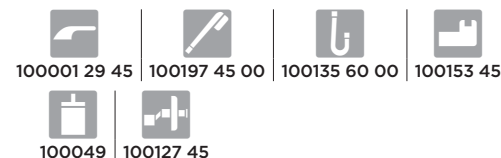

serie Tau 2 | Acabado cromado | Chromed finish

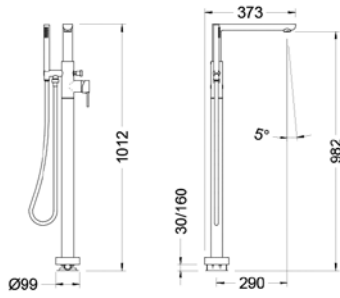

Ref.: 65119 29 45 66
Monomando de pie para bañera Tau 2
 Tau 2 Floor single lever mixer for bath

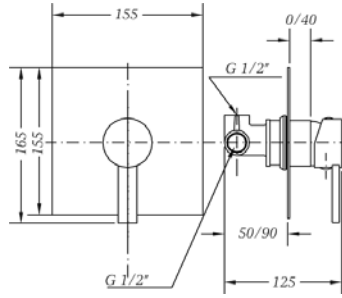

Ref.: 65115 29 45 66
Monomando de ducha empotrado
 Built-in single lever shower mixer

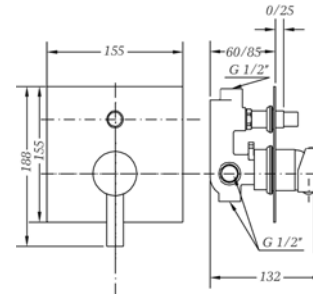
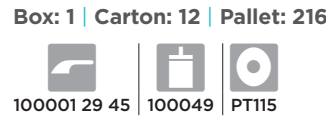

Ref.: 65116 29 45 66
Monomando empotrado con inversor 2 vías
 2 way Built-in single lever mixer with diverter



serie Kenjo | Acabado cromado | Chromed finish

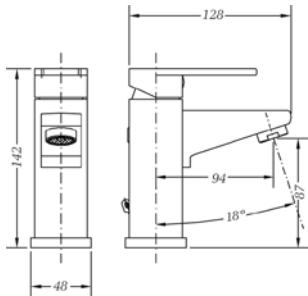

Ref.: 63130 26 45 66
Monomando de lavabo
 Single lever wash-basin mixer
Box: 1 | Carton: 20 | Pallet: 360

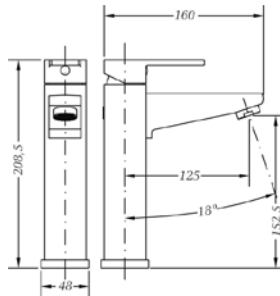

Ref.: 63134 26 45 66
Monomando de lavabo medio alto
 Medium height single lever wash-basin mixer

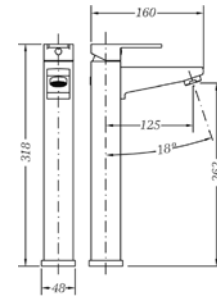
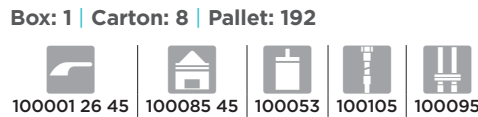

Ref.: 63136 26 45 66
Monomando de lavabo alto
 High single lever wash-basin mixer

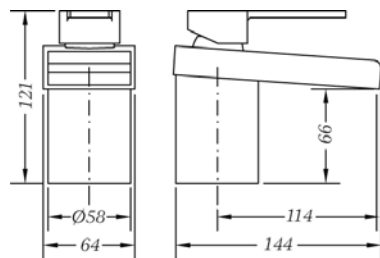
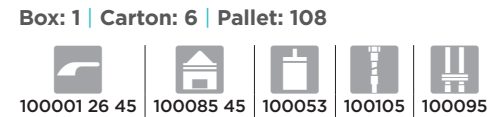

Ref.: 63137 26 45 66
Monomando de lavabo cascada
 Waterfall single lever wash-basin mixer

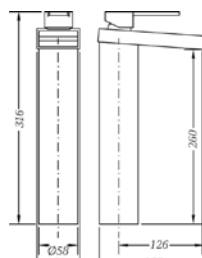
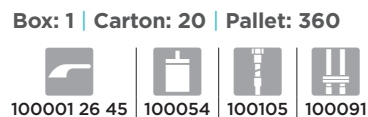

Ref.: 63138 26 45 66
Monomando de lavabo cascada alto
 High waterfall single lever wash-basin mixer

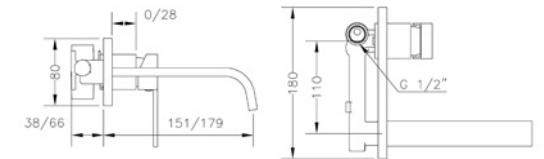
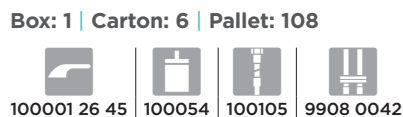

Ref.: 63131 26 45 66
Monomando de lavabo empotrado caño 16 cm
 Built-in wash-basin mixer 16 cm spout

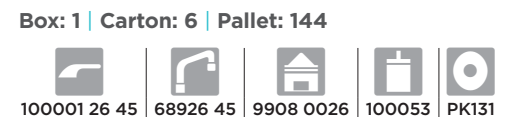

serie Kenjo | Acabado cromado | Chromed finish

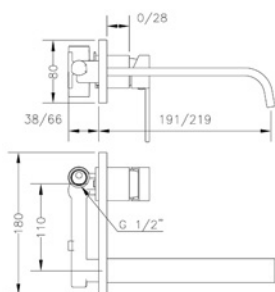

Ref.: 63132 26 45 66
Monomando de lavabo empotrado caño 22 cm
 Built-in wash-basin mixer 22 cm spout

Box: 1 | Carton: 6 | Pallet: 144

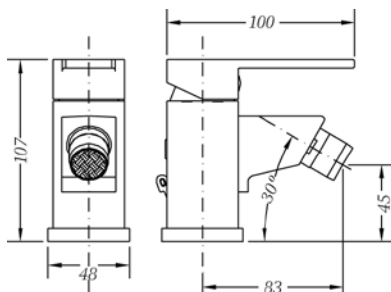

Ref.: 63140 26 45 66
Monomando de bidé
 Single lever bidet mixer

Box: 1 | Carton: 8 | Pallet: 384

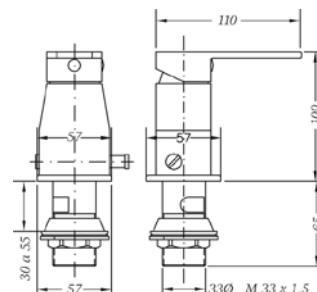

Ref.: 63142 26 45 66
Monomando de bidé con transmisión
 Single lever bidet mixer with diverter

Box: 1 | Carton: 12 | Pallet: 216

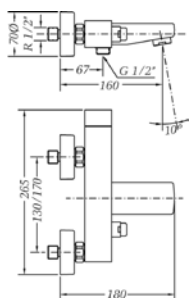

Ref.: 63100 26 45 67
Monomando de baño sin kit
 Single lever bath mixer without kit

Box: 1 | Carton: 6 | Pallet: 162

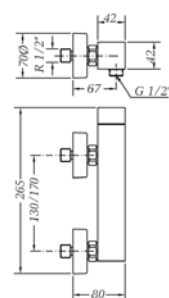

Ref.: 63110 26 45 67
Monomando de ducha sin kit
 Single lever shower mixer without kit

Box: 1 | Carton: 10 | Pallet: 180

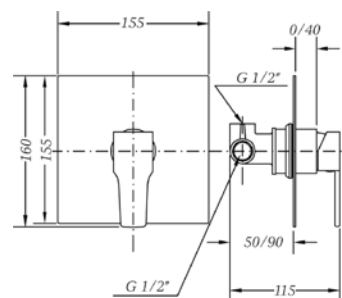

Ref.: 63115 26 45 66
Monomando de ducha empotrado
 Built-in single lever shower mixer

Box: 1 | Carton: 12 | Pallet: 216

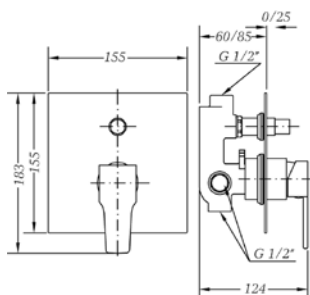

Ref.: 63116 26 45 66
Monomando empotrado con inversor 2 vías
 2 way Built-in single lever mixer with diverter

Box: 1 | Carton: 12 | Pallet: 216

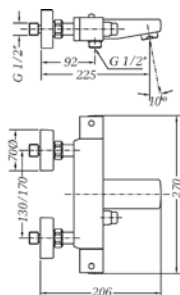

Ref.: 67100 26 45 67
Termostática de baño sin kit
 Thermostatic bath mixer without kit

Box: 1 | Carton: 6 | Pallet: 288

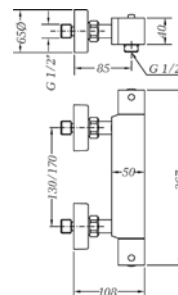
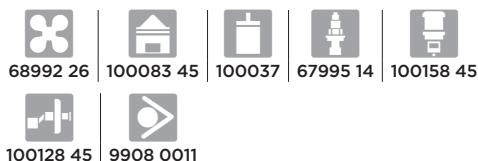

Ref.: 67110 26 45 67
Termostática ducha sin kit
 Thermostatic shower mixer without kit

Box: 1 | Carton: 9 | Pallet: 216



serie Kenjo | Acabado cromado | Chromed finish

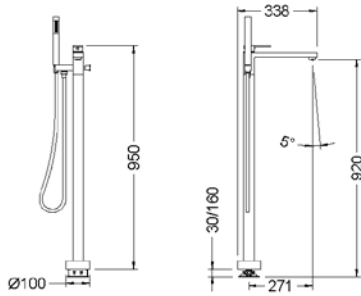

Ref.: 63119 26 45 66
Monomando de pie para bañera Kenjo
 Kenjo Floor single lever mixer for bath

Box: 1 | Carton: 2 | Pallet: 12



serie K8 | Acabado cromado | Chromed finish

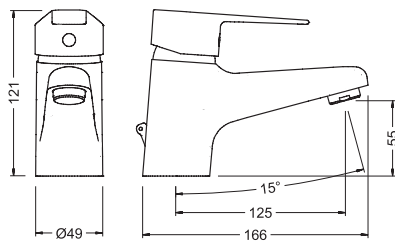

Ref.: 61130 28 45 66
Monomando de lavabo Plus
 Medium height single lever wash-basin mixer

Box: 1 | Carton: 8 | Pallet: 320

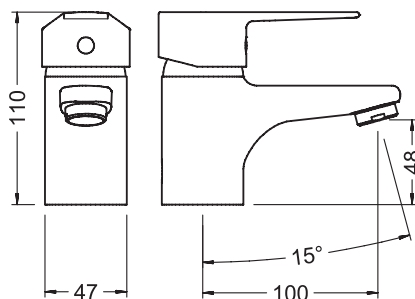

Ref.: 60130 28 45 66
Monomando de lavabo
 Single lever wash-basin mixer

Box: 1 | Carton: 20 | Pallet: 540

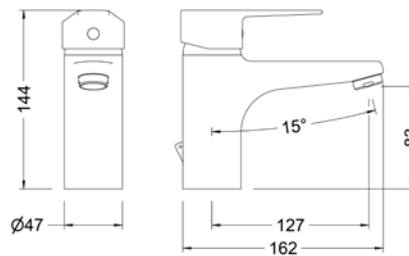

Ref.: 60134 28 45 66
Monomando de lavabo medio alto
 Medium height single lever wash-basin mixer

Box: 1 | Carton: 8 | Pallet: 240

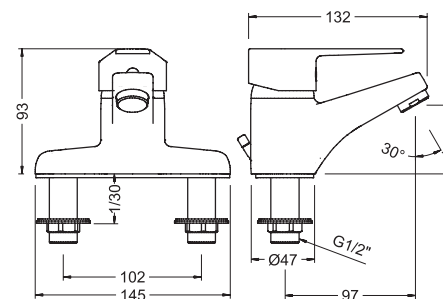

Ref.: 60188 28 45 66
Monomando de lavabo centerset 4"
 Single lever wash-basin mixer 4" centerset

Box: 1 | Carton: 12 | Pallet: 216

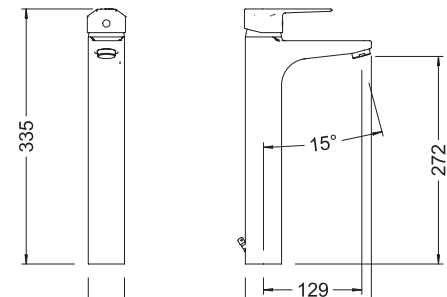

Ref.: 60136 28 45 66
Monomando de lavabo alto
 High single lever wash-basin mixer

Box: 1 | Carton: 10 | Pallet: 120

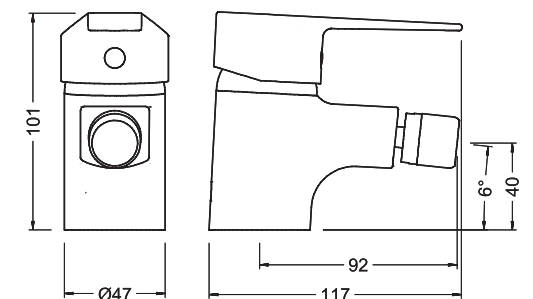

Ref.: 60140 28 45 66
Monomando de bidé
 Single lever bidet mixer

Box: 1 | Carton: 8 | Pallet: 480



serie K8 | Acabado cromado | Chromed finish

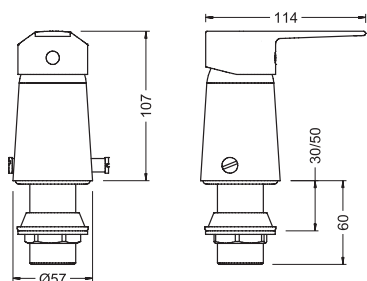

Ref.: 61142 28 45 66
Monomando de bidé con transmisión
 Single lever bidet mixer with diverter

Box: 1 | Carton: 12 | Pallet: 216

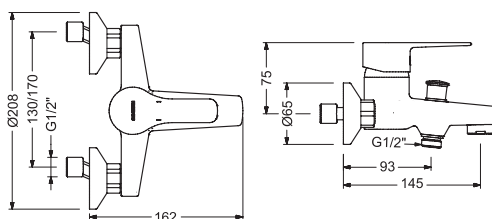

Ref.: 60100 28 45 66
Monomando de baño con kit
 Single lever bath mixer with kit

Box: 1 | Carton: 8 | Pallet: 128

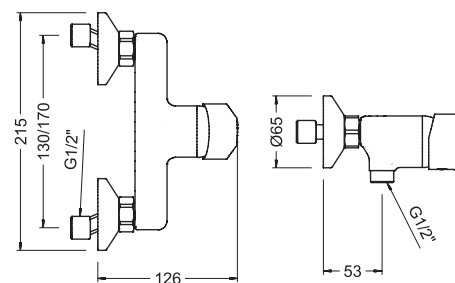

Ref.: 60110 28 45 66
Monomando de ducha con kit
 Single lever shower mixer with kit

Box: 1 | Carton: 8 | Pallet: 160

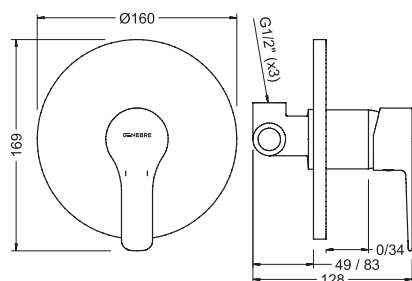
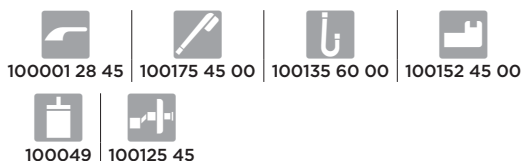

Ref.: 61115 28 45 66
Monomando de ducha empotrado
 Built-in single lever shower mixer

Box: 1 | Carton: 12 | Pallet: 216

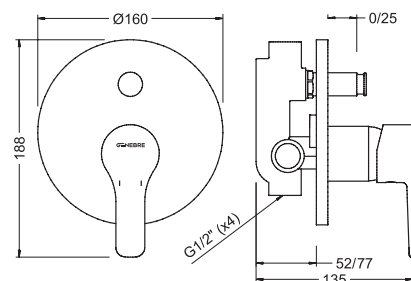

Ref.: 61116 28 45 66
Monomando empotrado con inversor 2 vías
 2 way Built-in single lever mixer with diverter

Box: 1 | Carton: 12 | Pallet: 216



serie Ge2 | Acabado cromado. | Chromed finish

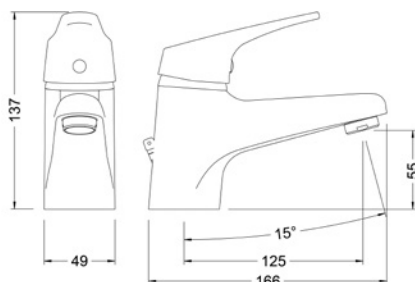

Ref.: 61130 22 45 66
Monomando de lavabo Plus
 Single lever Plus wash-basin mixer

Box: 1 | Carton: 20 | Pallet: 360

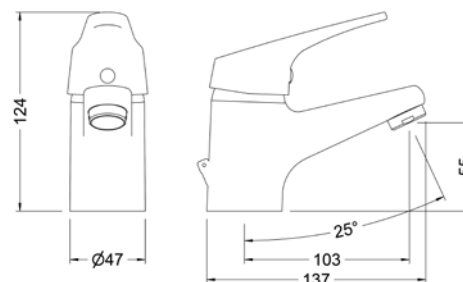

Ref.: 60130 22 45 66
Monomando de lavabo
 Single lever wash-basin mixer

Box: 1 | Carton: 20 | Pallet: 540

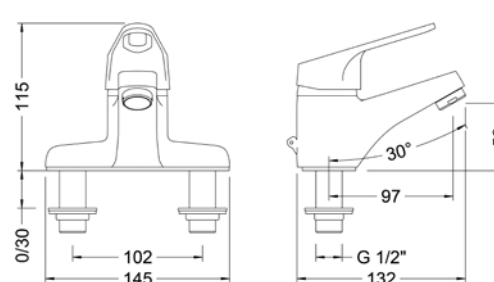

Ref.: 60188 22 45 66
Monomando de lavabo centerset 4"
 Single lever wash-basin mixer 4" centerset

Box: 1 | Carton: 12 | Pallet: 216



serie Ge2 | Acabado cromado | Chromed finish

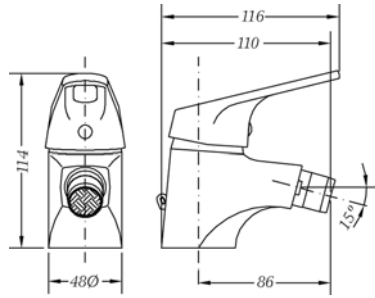

Ref.: 60140 22 45 66
Monomando de bidé
 Single lever bidet mixer
Box: 1 | Carton: 8 | Pallet: 480



100001 22 45 | 100086 45 | 100049 | 100103 | 100092

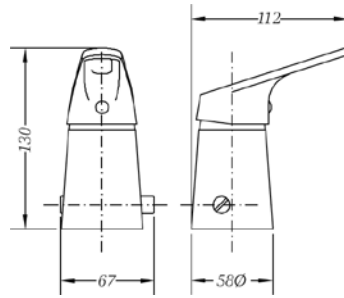

Ref.: 61142 22 45 66
Monomando de bidé con transmisión
 Single lever bidet mixer with diverter
Box: 1 | Carton: 12 | Pallet: 216



100001 22 45 | 9908 0381 | 100051
 100104 | 100111 | J15

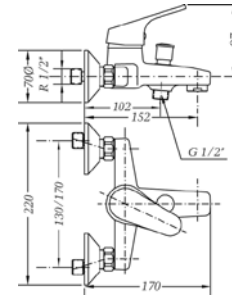

Ref.: 60100 22 45 66
Monomando de baño con kit
 Single lever bath mixer with kit
Box: 1 | Carton: 8 | Pallet: 128

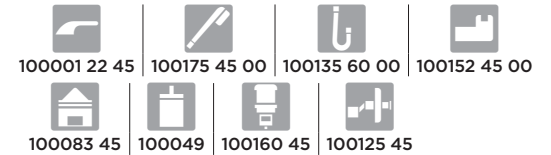

100001 22 45 | 100175 45 00 | 100135 60 00 | 100152 45 00
 100083 45 | 100049 | 100160 45 | 100125 45

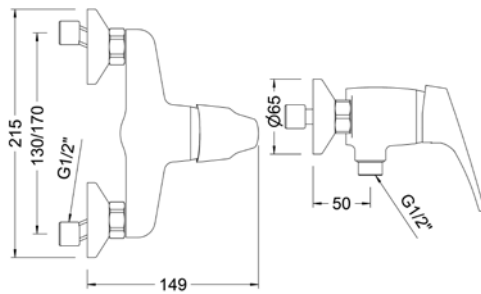

Ref.: 60110 22 45 66
Monomando de ducha con kit
 Single lever shower mixer with kit
Box: 1 | Carton: 8 | Pallet: 160

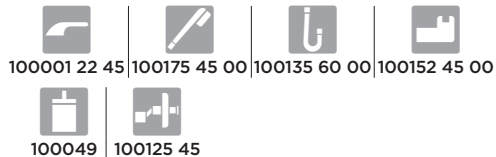

100001 22 45 | 100175 45 00 | 100135 60 00 | 100152 45 00
 100049 | 100125 45

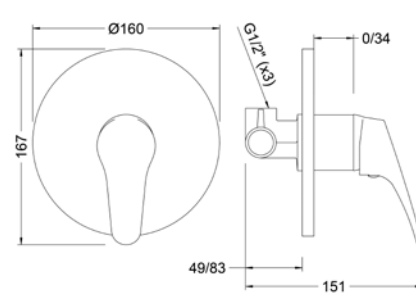

Ref.: 61115 22 45 66
Monomando de ducha empotrado
 Built-in single lever shower mixer
Box: 1 | Carton: 12 | Pallet: 216



100001 22 45 | 100049 | PS115

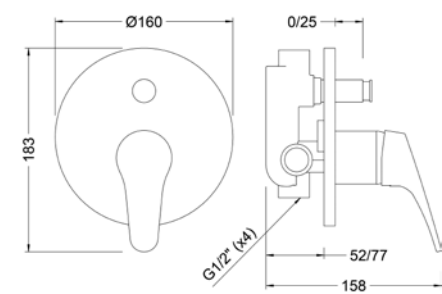

Ref.: 61116 22 45 66
Monomando empotrado con inversor 2 vías
 2 way Built-in single lever mixer with diverter
Box: 1 | Carton: 12 | Pallet: 216



100001 22 45 | 100049 | 100162 45 | PS116

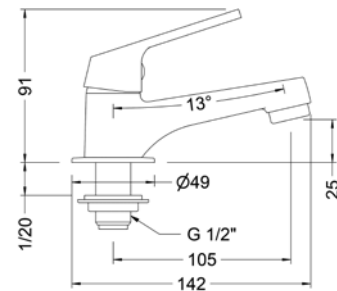

Ref.: 1002 04
Grifo lavabo 1 agua cartucho 25
 One-water wash-basin tap 25 cartridge

Box: 1 | Carton: 54 | Pallet: 972



100001 33 45 | 100085 45 | 100042 | 100098

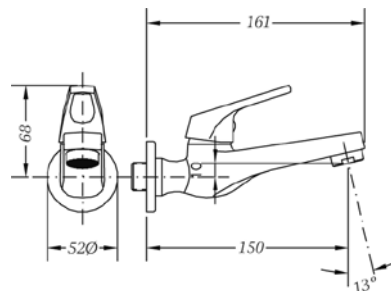

Ref.: 1003 04
Grifo lavabo mural 1 agua cartucho 25
 One-water wall wash-basin tap 25 cartridge

Box: 1 | Carton: 48 | Pallet: 864



100001 33 45 | 100085 45 | 100042

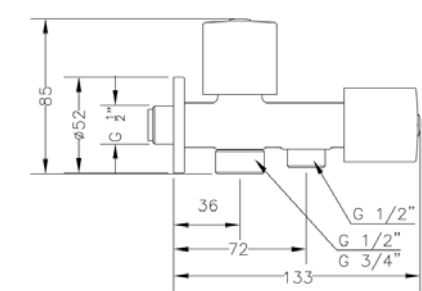

Ref.: 1023 04
Grifo doble combinable 1/2"-3/4" y 1/2"
 Double outlet tap 1/2"-3/4" and 1/2"

Box: 1 | Carton: 48 | Pallet: 864



68998 28 45 | 68995 09

serie Ge2 | Acabado cromado | Chromed finish

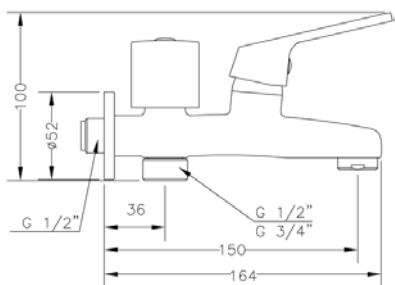

Ref.: 1024 04
Grifo doble combinable a 1/2"- 3/4" y Aireador
 Double outlet tap 1/2" - 3/4" and aerator

Box: 1 | Carton: 48 | Pallet: 864

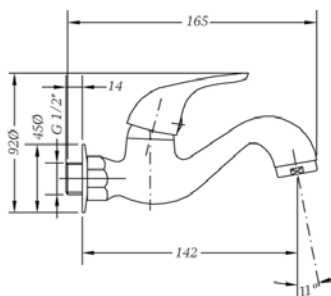

Ref.: 1006 04
Grifo lavabo mural 1 agua cartucho 25
 One-water wall wash-basin tap 25 cartridge

Box: 1 | Carton: 36 | Pallet: 864

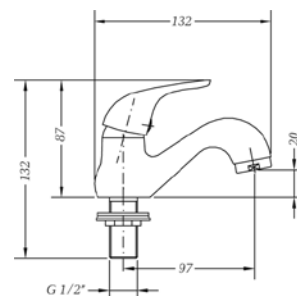

Ref.: 1007 04
Grifo lavabo 1 agua cartucho 25
 One-water wash-basin tap 25 cartridge

Box: 1 | Carton: 32 | Pallet: 768

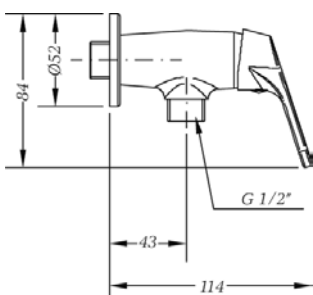

Ref.: 60001 22 45 67
Grifo bide mural 1 agua
 1 water wall bidet

Box: 1 | Carton: 54 | Pallet: 972



serie New Regent Classic | Montura 1/4 vuelta cierre cerámico | Ceramic headwork quarter turn

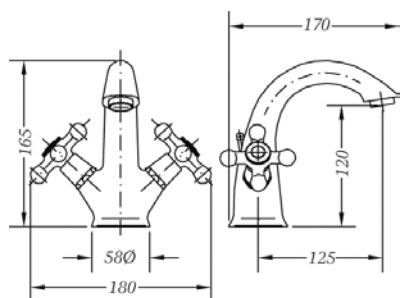

Ref.: 68506 09 45 66
Monobloc de lavabo cromo
 Chromed wash-basin mixer

Box: 1 | Carton: 8 | Pallet: 144

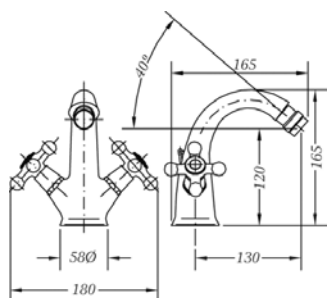

Ref.: 68516 09 45 66
Monobloc de bidé cromo
 Chromed bidet mixer

Box: 1 | Carton: 8 | Pallet: 144

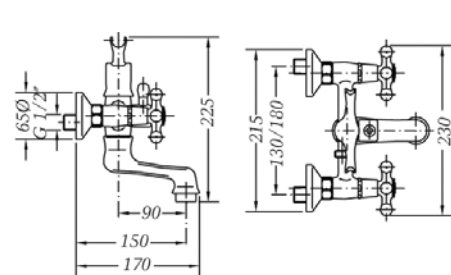

Ref.: 68526 09 45 66
Mezclador de baño cromo con kit
 Chromed bath mixer with kit

Box: 1 | Carton: 4 | Pallet: 72

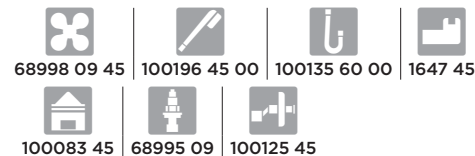

serie New Regent Classic | Montura 1/4 vuelta cierre cerámico | Ceramic headwork quarter turn

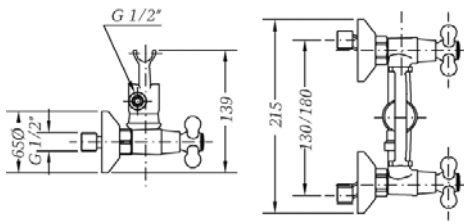

Ref.: 68531 09 45 66
Mezclador de ducha cromo con kit
 Chromed shower mixer with kit

Box: 1 | Carton: 8 | Pallet: 96

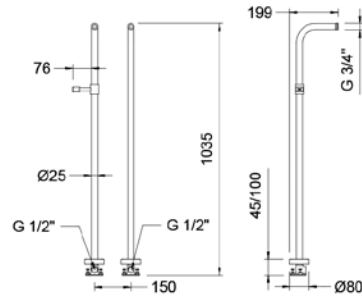

Ref.: 65120 45
Pies para mezclador de bañera
 Floor support for bath mixer

Box: 1 | Carton: 2

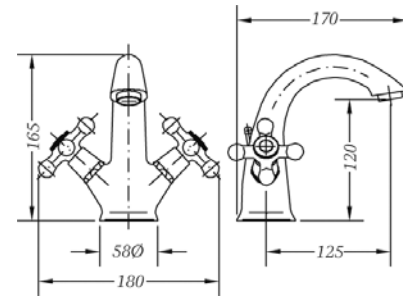

Ref.: 68506 09 43 66
Monobloc de lavabo bronce
 Bronze wash-basin mixer

Box: 1 | Carton: 8 | Pallet: 144

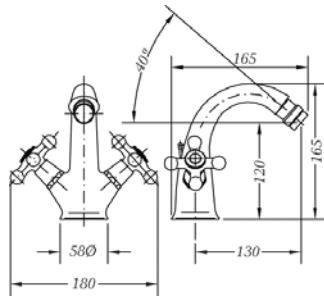

Ref.: 68516 09 43 66
Monobloc bidet bronce
 Bronze bidet mixer

Box: 1 | Carton: 8 | Pallet: 144

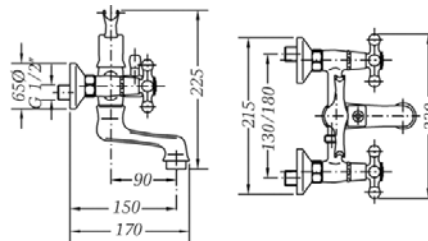

Ref.: 68526 09 43 66
Mezclador de baño bronce con kit
 Bronze bath mixer with kit

Box: 1 | Carton: 4 | Pallet: 72

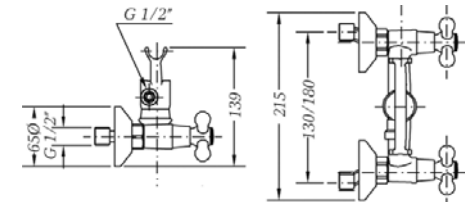
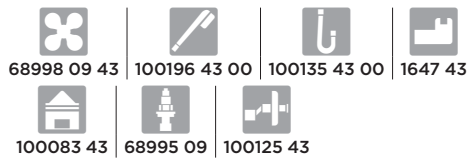

Ref.: 68531 09 43 66
Mezclador de ducha bronce con kit
 Bronze shower mixer with kit

Box: 1 | Carton: 8 | Pallet: 96

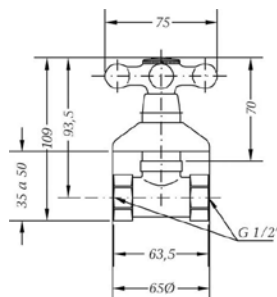

Ref.: 68590 09 43 66
Llave de paso 1/2" Bronce
 Bronze Stopcock 1/2"



serie New Regent | Acabado cromado. Montura 1/4 vuelta cierre cerámico | Chromed finish. Ceramic headwork quarter turn

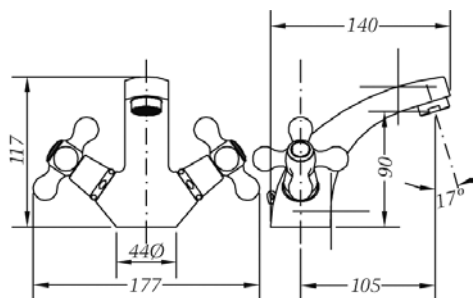

Ref.: 68505 09 45 66
Monobloc de lavabo
 Wash-basin mixer

Box: 1 | Carton: 12 | Pallet: 216

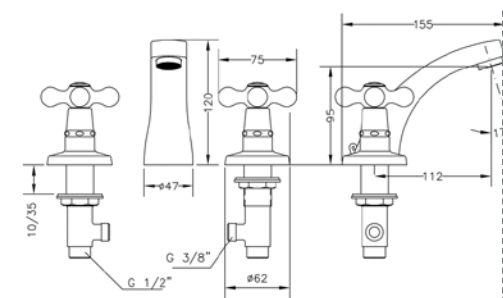

Ref.: 68510 09 45 66
Batería lavabo
 Widespread wash-basin mixer

Box: 1 | Carton: 10 | Pallet: 240

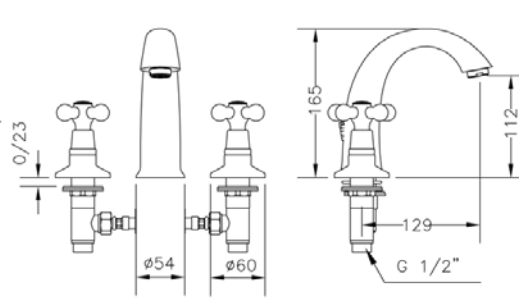

Ref.: 68120 09 45 66
Batería lavabo
 Widespread wash-basin mixer

Box: 1 | Carton: 6 | Pallet: 240

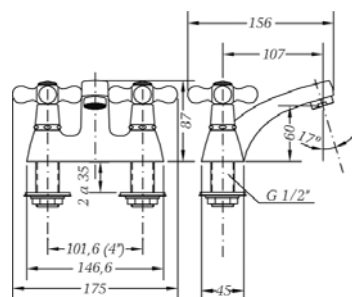

Ref.: 68511 09 45 66
Mezclador lavabo 4"
 Wash-basin mixer 4"

Box: 1 | Carton: 12 | Pallet: 216

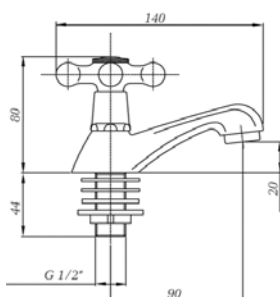

Ref.: 68500 09 45 66
Grifo lavabo
 Wash-basin tap

Box: 1 | Carton: 24 | Pallet: 240

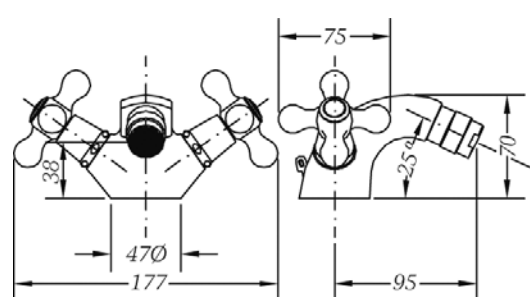

Ref.: 68515 09 45 66
Monobloc de bidé
 Bidet mixer

Box: 1 | Carton: 12 | Pallet: 216

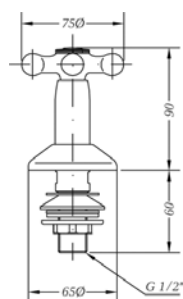

Ref.: 68520 09 45 66
Grifo bidé
 Bidet tap

Box: 1 | Carton: 24 | Pallet: 576

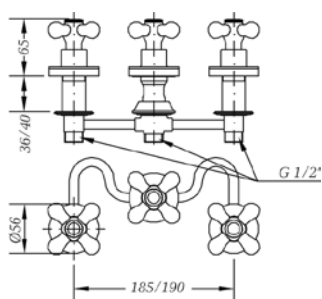

Ref.: 68142 09 45 66
Batería de bidé con transmisión
 Widespread bidet mixed with transmission

Box: 1 | Carton: 10 | Pallet: 240

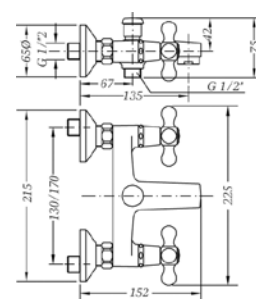

Ref.: 68525 09 45 66
Mezclador de baño con kit
 Bath mixer with kit

Box: 1 | Carton: 12 | Pallet: 216

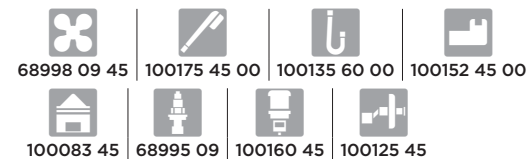

serie New Regent | Acabado cromado. Montura 1/4 vuelta cierre cerámico | Chromed finish. Ceramic headwork quarter turn

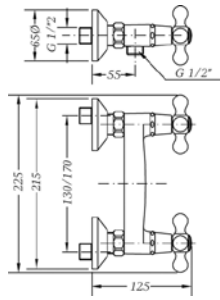

Ref.: 68530 09 45 66
Mezclador de ducha con kit
 Shower mixer with kit

Box: 1 | Carton: 12 | Pallet: 216

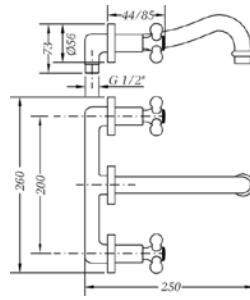
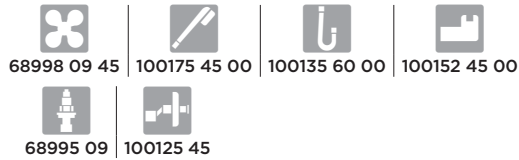

Ref.: 68131 09 45 66
Grupo de lavabo empotrado
 Built-in wash-basin mixer

Box: 1 | Carton: 10 | Pallet: 240

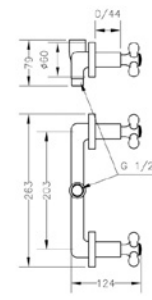

Ref.: 68535 09 45 66
Grupo ducha empotrado 8"
 Built-in 8" shower mixer

Box: 1 | Carton: 10 | Pallet: 240

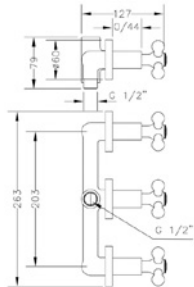

Ref.: 68527 09 45 66
Grupo baño empotrado 8" con inversor
 Built-in 8" bath mixer with diverter

Box: 1 | Carton: 10 | Pallet: 240

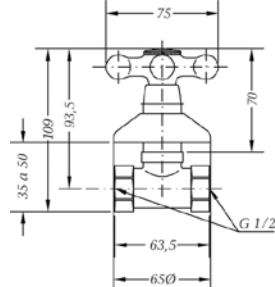

Ref.: 68590 09 45 66
Llave de paso 1/2"
 Stopcock 1/2"

Box: 1 | Carton: 24 | Pallet: 576

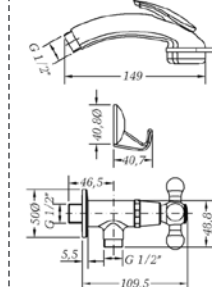

Ref.: 68001 09 45 66
Grifo de bidé con teleducha
 Bidet tap with shower

Box: 1 | Carton: 20 | Pallet: 360



serie Gamma | Acabado cromado. Montura convencional | Chromed finish. Conventional headwork

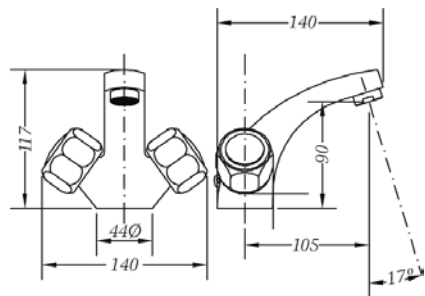

Ref.: 68130 11 45 66
Monobloc de lavabo
 Wash-basin mixer

Box: 1 | Carton: 12 | Pallet: 216

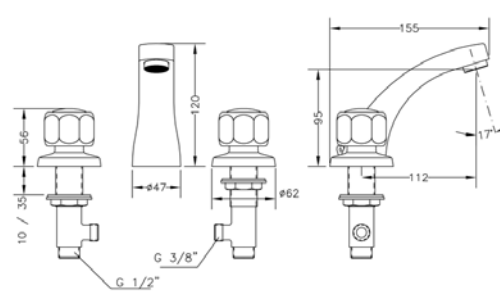
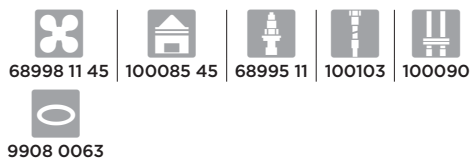

Ref.: 68120 11 45 66
Batería de lavabo
 Widespread wash-basin mixer

Box: 1 | Carton: 10 | Pallet: 240

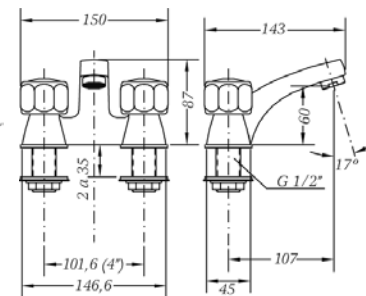

Ref.: 68122 11 45 66
Mezclador lavabo 4"
 Wash-basin mixer 4"

Box: 1 | Carton: 12 | Pallet: 216



serie Gamma | Acabado cromado. Montura convencional | Chromed finish. Conventional headwork

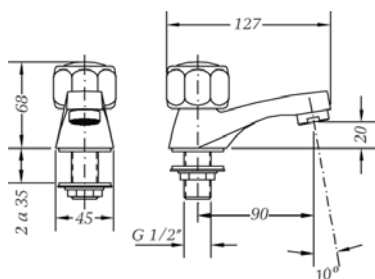

Ref.: 68180 11 45 66

Grifo de lavabo
Wash-basin tap

Box: 1 | Carton: 24 | Pallet: 576



68998 11 45 | 100085 45 | 68995 11 | 100098 | 9908 0063

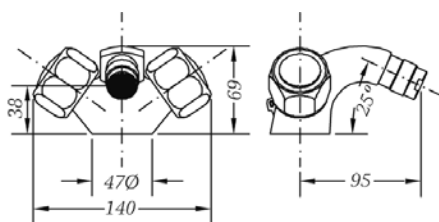

Ref.: 68140 11 45 66

Monobloc de bidé
Bidet mixer

Box: 1 | Carton: 12 | Pallet: 216



68998 11 45 | 100086 45 | 68995 11 | 100103 | 100090



9908 0063

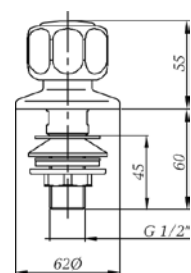

Ref.: 68160 11 45 66

Grifo bidé
Bidet tap

Box: 1 | Carton: 24 | Pallet: 576



68998 11 45 | 68995 11 | 9908 0063

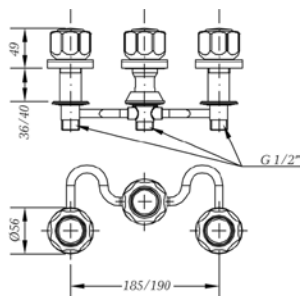

Ref.: 68142 11 45 66

Batería de bidé con transmisión
Widespread bidet mixer with transmission

Box: 1 | Carton: 10 | Pallet: 240



68998 11 45 | 9908 0381 | 68995 11 | 100174 45



9908 0063

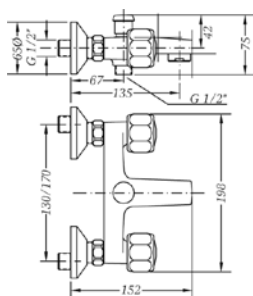

Ref.: 68100 11 45 66

Mezclador de baño con kit
Bath mixer with kit

Box: 1 | Carton: 12 | Pallet: 216



68998 11 45 | 100175 45 00 | 100135 60 00 | 100152 45 00



100083 45 | 68995 11 | 100160 45 | 100125 45 | 9908 0063

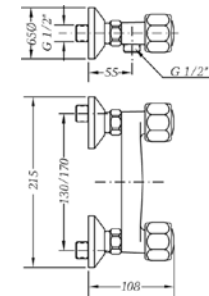

Ref.: 68110 11 45 66

Mezclador de ducha con kit
Shower mixer with kit

Box: 1 | Carton: 12 | Pallet: 216



68998 11 45 | 100175 45 00 | 100135 60 00 | 100152 45 00



68995 11 | 100125 45 | 9908 0063

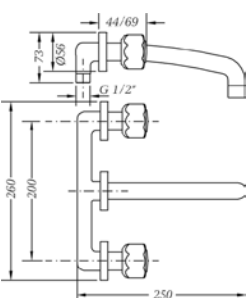

Ref.: 68131 11 45 66

Grupo de lavabo empotrado
Built-in wash-basin

Box: 1 | Carton: 10 | Pallet: 240



68998 11 45 | 68913 45 | 9908 0433 | 67896 45



9908 0386 | 9908 0387 | 9908 0063

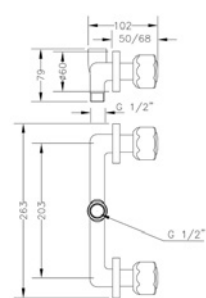

Ref.: 68115 11 45 66

Grupo ducha empotrado 8 inch
Built-in 8 inch shower mixer

Box: 1 | Carton: 10 | Pallet: 240



68998 11 45 | 67896 45 | 9908 0063

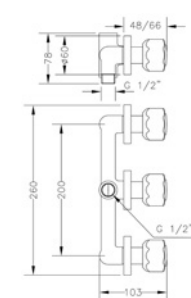

Ref.: 68116 11 45 66

Grupo baño empotrado 8 inch con inversor
Built-in 8 inch bath mixer with diverter

Box: 1 | Carton: 10 | Pallet: 240



68998 11 45 | 67896 45 | 100173 45 | 9908 0063

serie Gamma | Acabado cromado. Montura convencional | Chromed finish. Conventional headwork

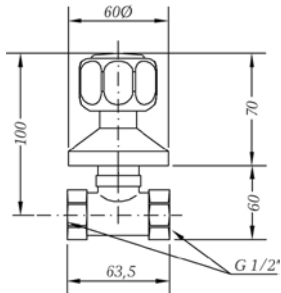

Ref.: 68170 11 45 66
Llave de paso 1/2"
 Stopcock 1/2"

Box: 1 | Carton: 24 | Pallet: 576

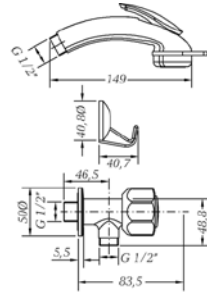
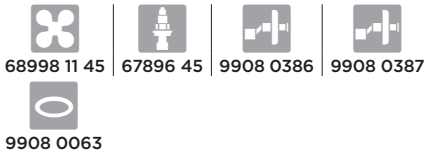

Ref.: 68001 11 45 66
Grifo de bidé con teleducha
 Bidet tap with shower

Box: 1 | Carton: 20 | Pallet: 360



serie Kalo | Acabado cromado. Montura 1/4 vuelta cierre cerámico | Ceramic headwork quarter turn

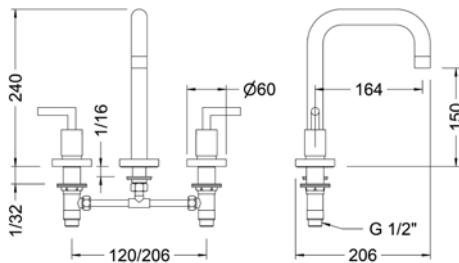

Ref.: 68120 07 45 66
Batería de lavabo caño recto
 Widespread wash-basin mixer with straight pipe spout

Box: 1

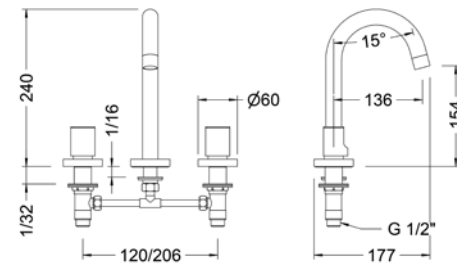
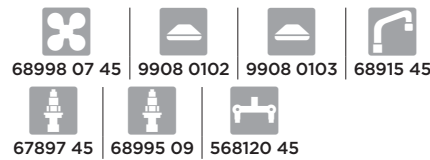

Ref.: 68124 07 45 66
Batería de lavabo caño cisne
 Widespread wash-basin mixer with swan pipe spout

Box: 1

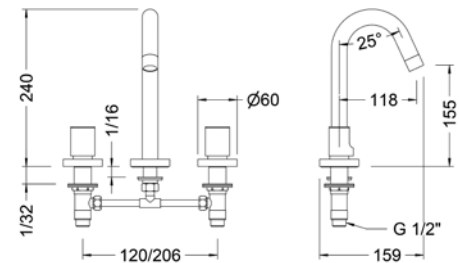
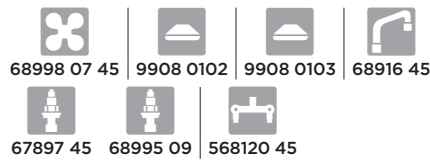

Ref.: 68125 07 45 66
Batería de lavabo caño inclinado
 Widespread wash-basin mixer with sloping pipe spout

Box: 1

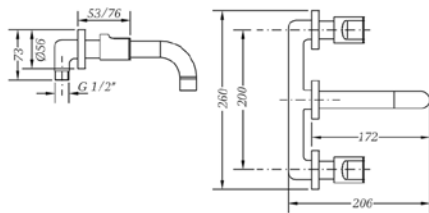
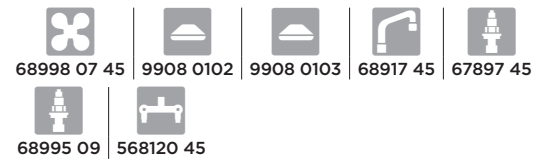

Ref.: 68131 07 45 66
Grupo de lavabo empotrado caño 16 cm
 Built-in wash-basin mixer with 16 cm pipe spout

Box: 1

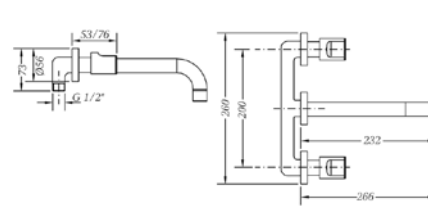

Ref.: 68132 07 45 66
Grupo de lavabo empotrado caño 22 cm
 Built-in wash-basin with 22 cm pipe spout

Box: 1

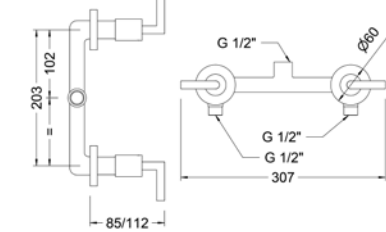
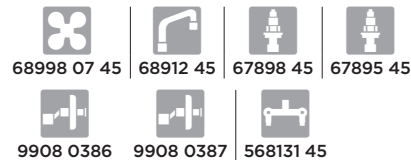

Ref.: 68115 07 45 66
Grupo ducha empotrado 8"
 Built-in 8" shower mixer

Box: 1

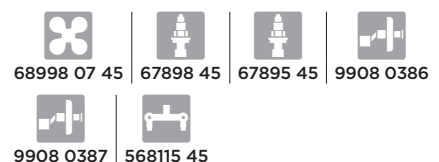

serie Kalo | Acabado cromado. Montura 1/4 vuelta cierre cerámico | Ceramic headwork quarter turn

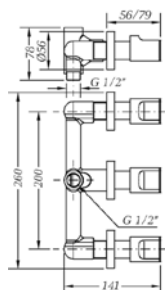

Ref.: 68116 07 45 66
Grupo baño empotrado 8" con inversor
 Built-in 8" bath mixer with diverter

Box: 1

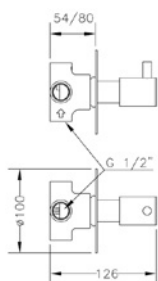
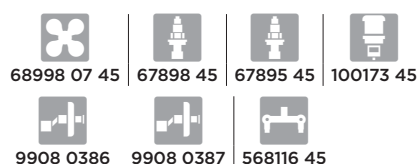

Ref.: 63114 30 45 66
Inversor cerámico 3 vías empotrado placa redonda
 Built-in 3 way ceramic diverter with round plate

Box: 1 | Carton: 8 | Pallet: 384

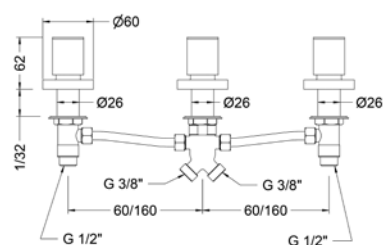

Ref.: 68113 07 45 66
Batería de baño con inversor
 Widespread bath mixer with diverter

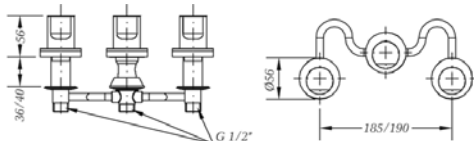

Ref.: 68142 07 45 66
Batería de bidé con transmisión
 Widespread bidet mixer with transmission

Box: 1

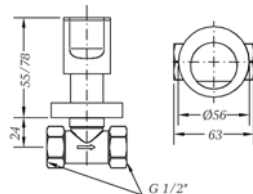
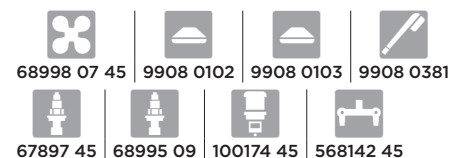

Ref.: 68170 07 45 66
Llave de paso 1/2"
 Stopcock 1/2"

Box: 1

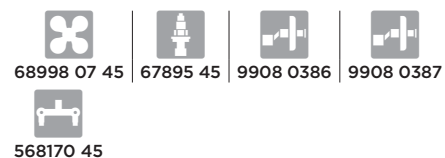

Las series Kalo, Kross e Ixo nacen de la combinación de diferentes componentes: cuerpos, caños y volantes.

Busque la combinación que mejor se adapte a su baño.

Puede pedirla utilizando la referencia del catálogo (conjunto) o bien por referencia de cada uno de los componentes

En este apartado podrá identificar fácilmente las referencias de cada componente necesario.

The series Kalo, Kross and Ixo are born from the combination of different components: bodies, pipes and handles.

Look for the combination that best suits your bathroom.

You can order it using the set reference or by components reference.

In this section you can easily identify the references of each required component

serie Kross | Acabado cromado. Montura 1/4 vuelta cierre cerámico | Ceramic headwork quarter turn

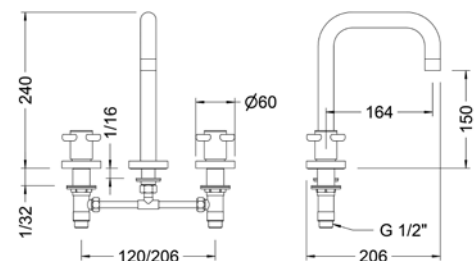

Ref.: 68120 08 45 66
Batería de lavabo caño recto
 Widespread wash-basin mixer with straight pipe spout

Box: 1

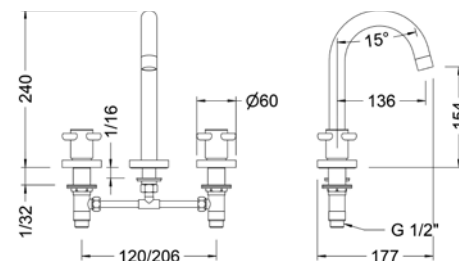
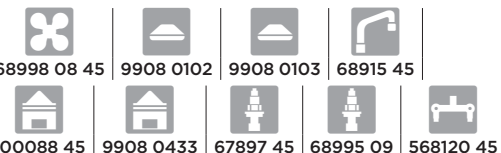

Ref.: 68124 08 45 66
Batería de lavabo caño cisne
 Widespread wash-basin mixer with swan pipe spout

Box: 1

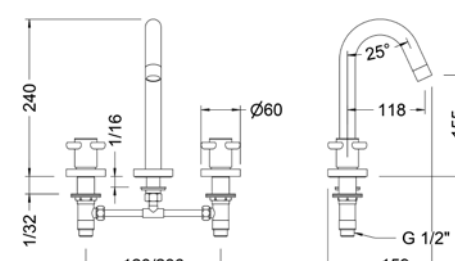
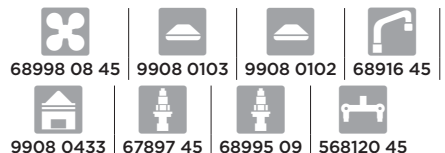

Ref.: 68125 08 45 66
Batería de lavabo caño inclinado
 Widespread wash-basin mixer with sloping pipe spout

Box: 1

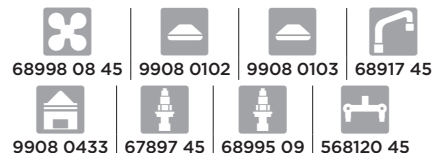

serie Kross | Acabado cromado. Montura 1/4 vuelta cierre cerámico | Ceramic headwork quarter turn

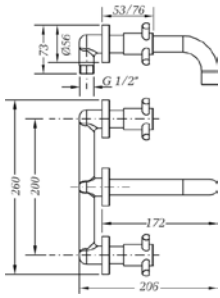

Ref.: 68131 08 45 66
Grupo de lavabo empotrado caño 16 cm
 Built-in wash-basin mixer with 16 cm pipe spout

Box: 1

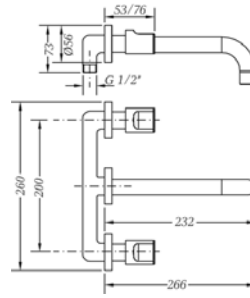

Ref.: 68132 08 45 66
Grupo de lavabo empotrado caño 22 cm
 Built-in wash-basin mixer with 22cm pipe spout

Box: 1

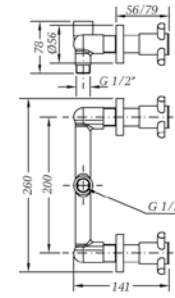

Ref.: 68115 08 45 66
Grupo ducha empotrado 8"
 Built-in 8" shower mixer

Box: 1

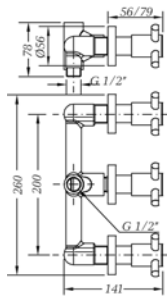
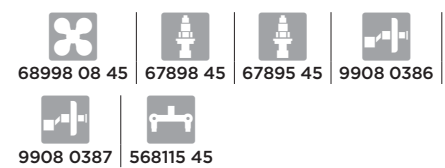

Ref.: 68116 08 45 66
Grupo ducha empotrado 8" con inversor
 Built-in 8" bath mixer with diverter

Box: 1

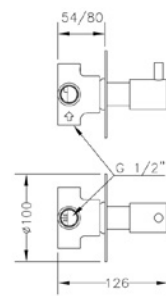
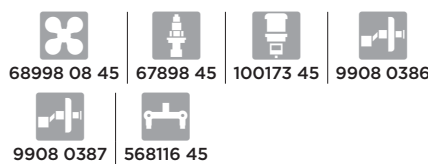

Ref.: 63114 30 45 66
Inversor cerámico 3 vías empotrado placa redonda
 Built-in 3 way ceramic diverter with round plate

Box: 1 | Carton: 8 | Pallet: 384

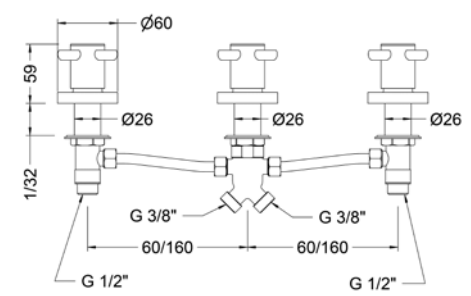

Ref.: 68113 08 45 66
Batería de baño con inversor
 Widespread bath mixer with diverter

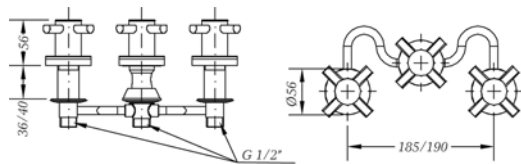

Ref.: 68142 08 45 66
Batería de bidé con transmisión
 Widespread bidet mixer with transmission

Box: 1

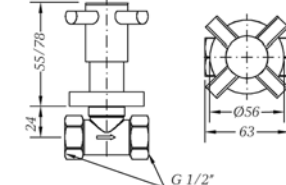

Ref.: 68170 08 45 66
Llave de paso 1/2"
 Stopcock 1/2"

Box: 1

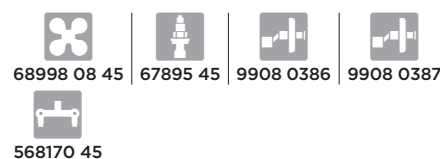

Las series Kalo, Kross e Ixo nacen de la combinación de diferentes componentes: cuerpos, caños y volantes.

Busque la combinación que mejor se adapte a su baño.

Puede pedirla utilizando la referencia del catálogo (conjunto) o bien por referencia de cada uno de los componentes

En este apartado podrá identificar fácilmente las referencias de cada componente necesario.

The series Kalo, Kross and Ixo are born from the combination of different components: bodies, pipes and handles.

Look for the combination that best suits your bathroom.

You can order it using the set reference or by components reference.

In this section you can easily identify the references of each required component

serie Ixo | Acabado cromado. Montura 1/4 vuelta cierre cerámico | Chromed finish. Ceramic headwork quarter turn

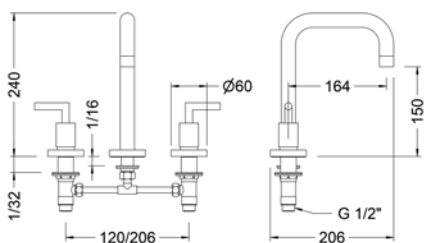

Ref.: 68120 12 45 66
Batería de lavabo caño recto
 Widespread wash-basin mixer with straight pipe spout

Box: 1

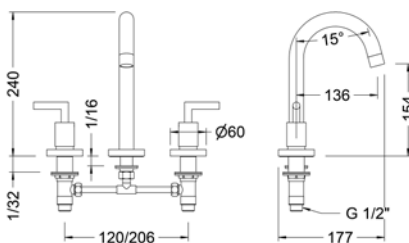
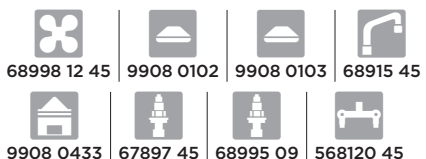

Ref.: 68124 12 45 66
Batería de lavabo caño cisne
 Widespread wash-basin mixer with swan pipe spout

Box: 1

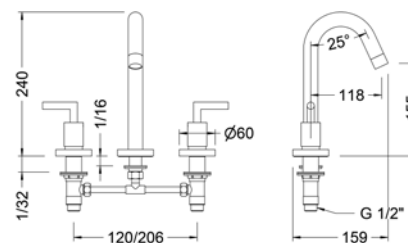
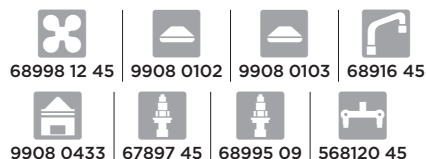

Ref.: 68125 12 45 66
Batería de lavabo caño inclinado
 Widespread wash-basin mixer with sloping pipe spout

Box: 1

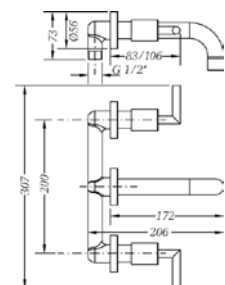
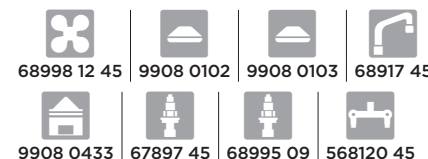

Ref.: 68131 12 45 66
Grupo de lavabo empotrado caño 16 cm
 Built-in wash-basin mixer with 16 cm pipe spout

Box: 1

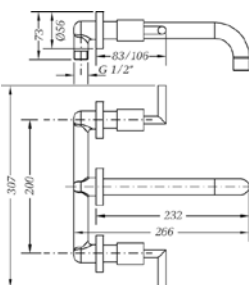

Ref.: 68132 12 45 66
Grupo de lavabo empotrado caño 22 cm
 Built-in wash-basin mixer with 22 cm pipe spout

Box: 1

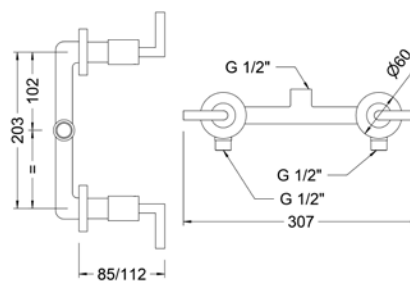

Ref.: 68115 12 45 66
Grupo ducha empotrado 8"
 Built-in 8" shower mixer

Box: 1

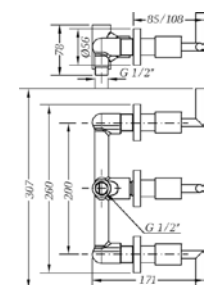
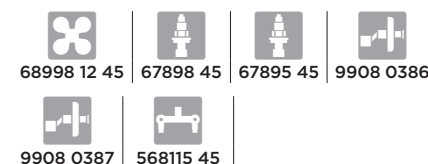

Ref.: 68116 12 45 66
Grupo ducha empotrado 8" con inversor
 Built-in 8" shower mixer with diverter

Box: 1

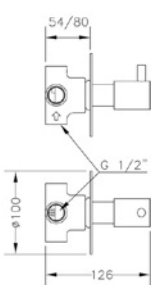
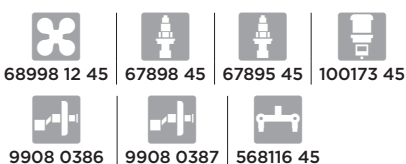

Ref.: 63114 30 45 66
Inversor cerámico 3 vías empotrado placa redonda
 Built-in 3 way ceramic diverter with round plate

Box: 1 | Carton: 8 | Pallet: 384

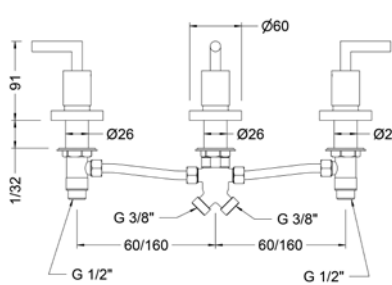

Ref.: 68113 12 45 66
Batería de baño con inversor
 Widespread bath mixer with diverter



serie Ixo | Acabado cromado. Montura 1/4 vuelta cierre cerámico | Chromed finish. Ceramic headwork quarter turn

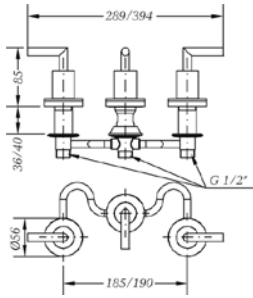

Ref.: 68142 12 45 66
Batería de bidé con transmisión
 Widespread bidet mixer with transmission

Box: 1

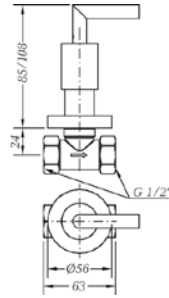
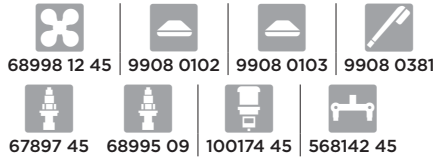

Ref.: 68170 12 45 66
Llave de paso 1/2"
 Stopcock 1/2"

Box: 1

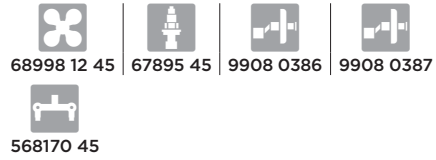

Las series Kalo, Kross e Ixo nacen de la combinación de diferentes componentes: cuerpos, caños y volantes. Busque la combinación que mejor se adapte a su baño.

Puede pedirla utilizando la referencia del catálogo (conjunto) o bien por referencia de cada uno de los componentes

En este apartado podrá identificar fácilmente las referencias de cada componente necesario.

The series Kalo, Kross and Ixo are born from the combination of different components: bodies, pipes and handles.

Look for the combination that best suits your bathroom. You can order it using the set reference or by components reference.

In this section you can easily identify the references of each required component

Duchas Shower

serie Koral | Acabado cromado | Chromed finish

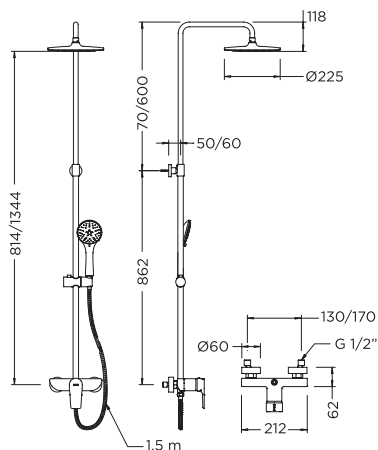

Ref.: CM64110 32

Columna monomando extensible con kit

Single lever extensible column with kit

Box: 1 | Carton: 2 | Pallet: 18

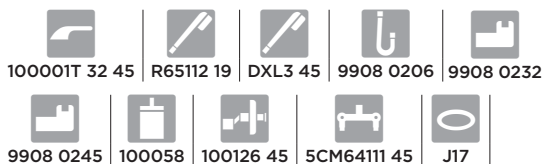

serie Oslo | Acabado cromado | Chromed finish

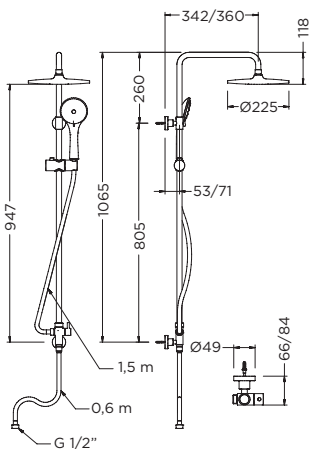

Ref.: 1744 45

Set columna fija con kit

Fixed column set with kit

Box: 1 | Carton: 4 | Pallet: 24

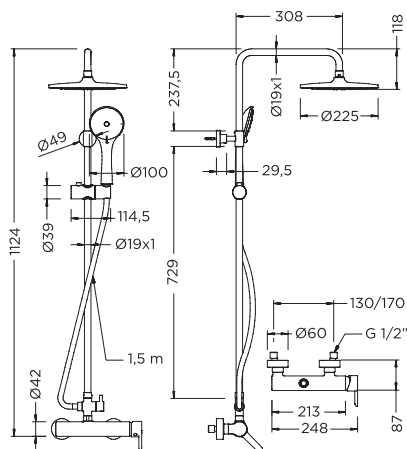

Ref.: CM65110 19

Columna monomando fija con kit

Single lever fixed column with kit

Box: 1 | Carton: 4 | Pallet: 24

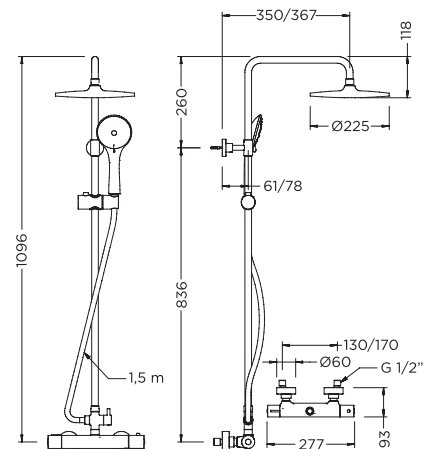

Ref.: CT67110 19

Columna termostática fija con kit

Thermostatic fixed column with kit

Box: 1 | Carton: 4 | Pallet: 24

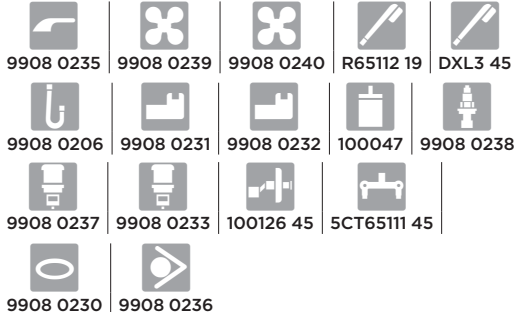

serie Oslo | Acabado cromado | Chromed finish

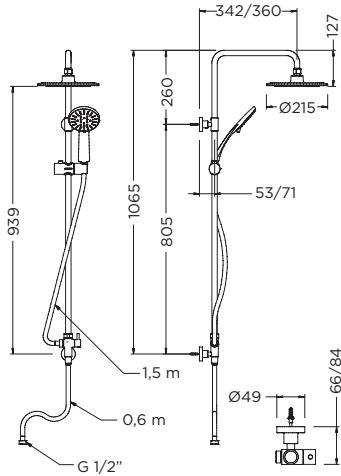

Ref.: 1744 41
Set columna fija con kit
 Fixed column set with kit

- | | | | | |
|---|---|---|---|---|
|  |  |  |  |  |
| 9908 0376 | R65112 41 | 9908 0284 | 9908 0368 | 9908 0377 |
|  |  |  |  |  |
| 9908 0367 | 9908 0366 | 9908 0233 | 51744 41 | 9908 0230 |

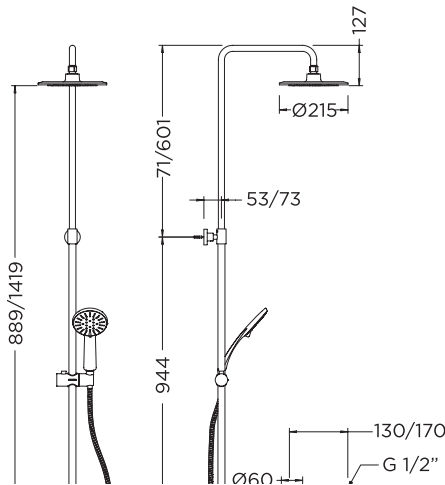

Ref.: CM65111 19 41
Columna monomando extensible con kit
 Single lever extensible column with kit

- | | | | |
|--|--|--|---|
|  |  |  |  |
| 9908 0370 | 9908 0278 | R65112 41 | 9908 0284 |
|  |  |  |  |
| 5CM65111 41 | 9908 0368 | 9908 0367 | 9908 0366 |
|  |  |  |  |
| 100053 | 9908 0369 | 9908 0233 | 9908 0289 |
| | | | J17 |

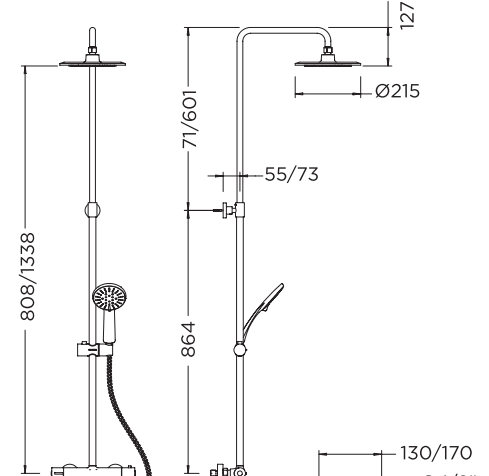







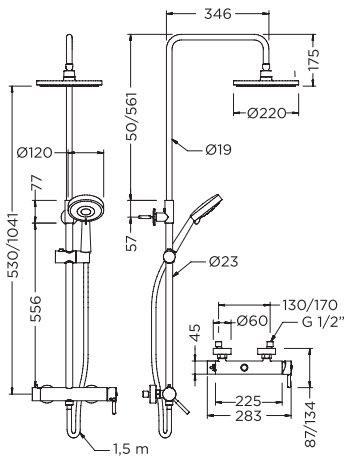





Ref.: CT67111 19 41
Columna termostática extensible con kit
 Thermostatic extensible column with kit

- | | | | |
|--|--|--|--|
|  |  |  |  |
| 9908 0375 | R65112 41 | 9908 0284 | 5CT67111 41 |
|  |  |  |  |
| 9908 0368 | 9908 0367 | 9908 0366 | 9908 0374 |
|  |  |  |  |
| 9908 0372 | 9908 0373 | 9908 0289 | J17 |
| | | | 9908 0236 |

serie Tau | Acabado cromado | Chromed finish







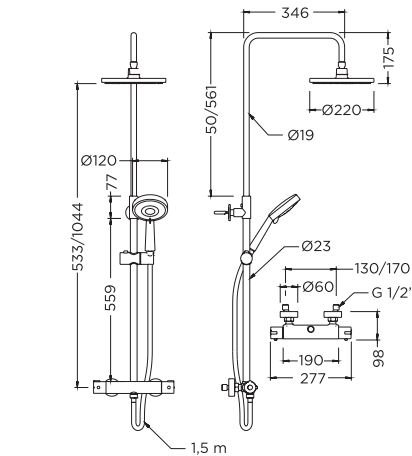







Ref.: CM65110 18
Columna monomando extensible con kit
 Single lever extensible column with kit
Box: 1 | Carton: 2 | Pallet: 8

- | | | | | |
|---|---|---|---|---|
|  |  |  |  |  |
| 9908 0218 | 9908 0217 | R65112 18 | DXT5 45 | 9908 0206 |
|  |  |  |  |  |
| 9908 0201 | 9908 0226 | 100053 | 9908 0221 | 100126 45 |
|  |  | | | |
| 5CM65110 45 | 9908 0200 | | | |







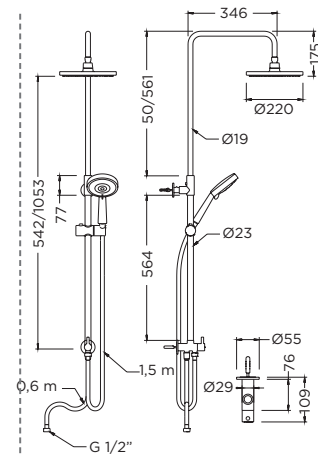





Ref.: CT67110 18
Columna termostática extensible con kit
 Thermostatic extensible column with kit
Box: 1 | Carton: 2 | Pallet: 8

- | | | | | |
|---|---|---|--|---|
|  |  |  |  |  |
| 68988 18 | R65112 18 | DXT5 45 | 9908 0206 | 9908 0201 |
|  |  |  |  |  |
| 9908 0226 | 100037 | 100069 | 100126 45 | 5CT65110 45 |
|  |  | | | |
| 9908 0200 | 9908 0011 | | | |



Ref.: 1745 45
Set columna con ducha, soporte y flexo
 Column set with shower, holder and flexible hose
Box: 1 | Carton: 2 | Pallet: 8

- | | | | | |
|---|---|---|---|---|
|  |  |  |  |  |
| 9908 0205 | R65112 18 | DXT5 45 | 9908 0203 | 9908 0206 |
|  |  |  |  |  |
| 9908 0201 | 9908 0226 | 9908 0204 | 51745 45 | 9908 0200 |

serie Tau2 | Acabado cromado. Montura 1/4 vuelta cierre cerámico | Chromed finish. Ceramic headwork quarter turn

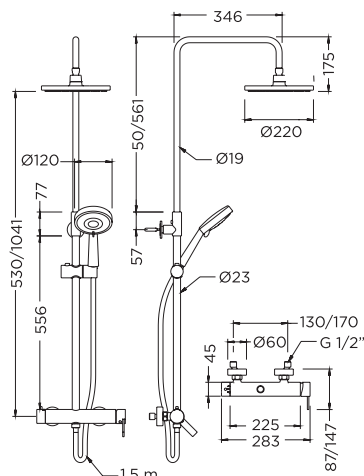

Ref.: CM65110 29
Columna monomando extensible con kit
 Single lever extendable column with kit

Box: 1 | Carton: 2 | Pallet: 8

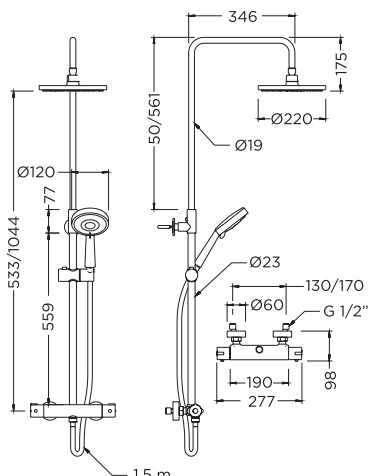
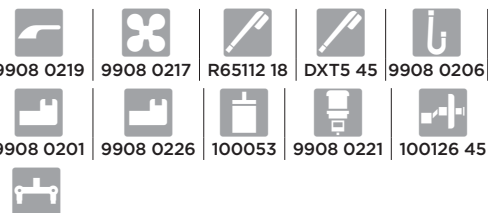

Ref.: CT67110 18
Columna termostática extensible con kit
 Thermostatic extendable column with kit

Box: 1 | Carton: 2 | Pallet: 8

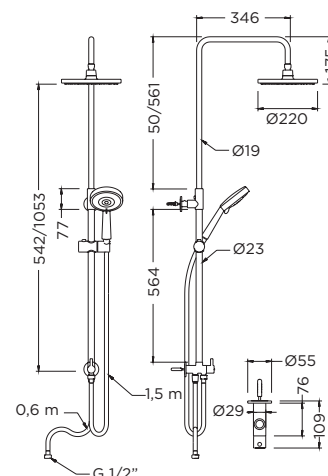
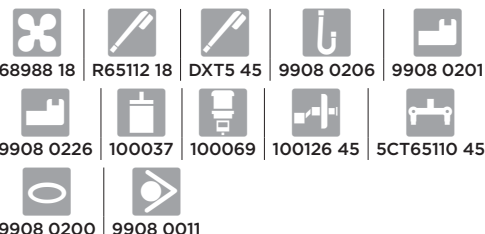

Ref.: 1745 45
Set columna con ducha, soporte y flexo
 Column set with shower, holder and flexible hose

Box: 1 | Carton: 2 | Pallet: 8

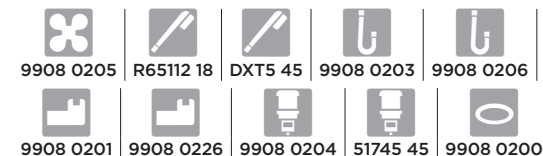

serie Kenjo | Acabado cromado | Chromed finish

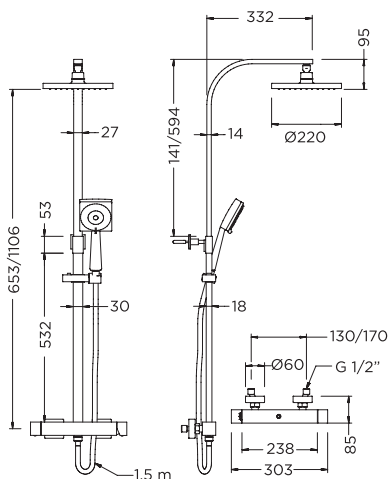

Ref.: CM63110 26
Columna monomando extensible con kit
 Single lever extendable column with kit

Box: 1 | Carton: 2 | Pallet: 24

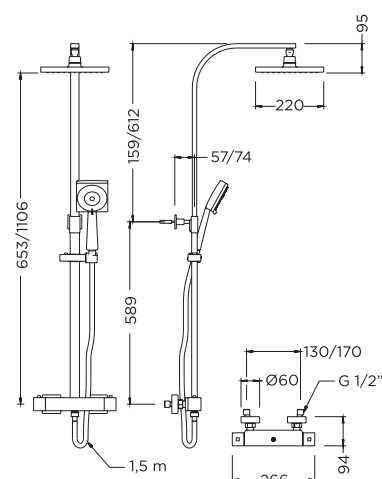

Ref.: CT67110 26
Columna termostática extensible con kit
 Thermostatic extendable column with kit

Box: 1 | Carton: 2 | Pallet: 24

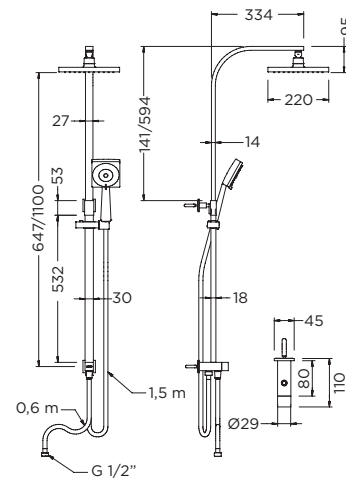

Ref.: 1746 45
Set columna con ducha, soporte y flexo
 Column set with shower, holder and flexible hose

Box: 1 | Carton: 2 | Pallet: 24



Cocina Kitchen

serie Korál |

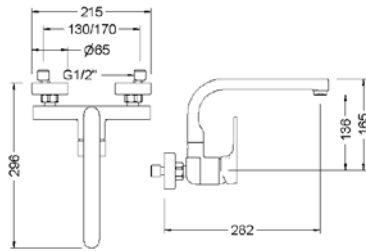

Ref.: 64192 32 45 66
Monomando de fregadera mural Korál
 Korál Wall single lever sink mixer

Box: 1 | Carton: 6 | Pallet: 72

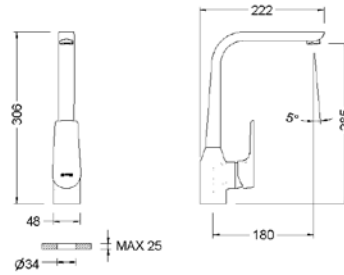
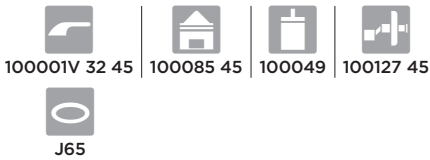

Ref.: 64201 32 45 66
Monomando de fregadera Korál
 Korál Single lever sink mixer

Box: 1 | Carton: 8 | Pallet: 144

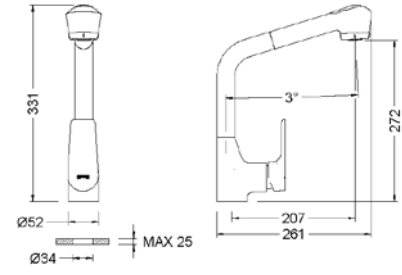
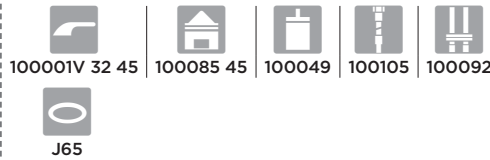

Ref.: 64206 32 45 66
Monomando de fregadera ducha extraíble Korál
 Korál Single lever sink mixer with pull-out spray

Box: 1 | Carton: 6 | Pallet: 108

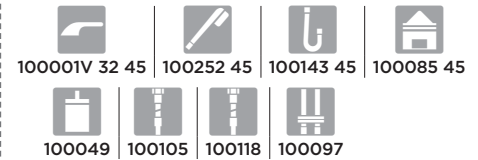

serie Oslo | Acabado cromado | Chromed finish

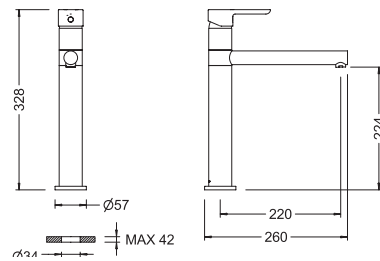

Ref.: 65200 19 45 66
Monomando de fregadera
 Single lever sink mixer

Box: 1 | Carton: 10 | Pallet: 90

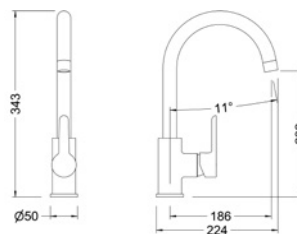
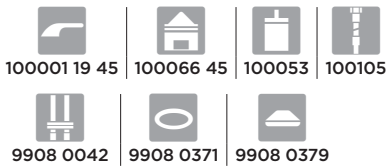

Ref.: 65203 19 45 66
Monomando de fregadera apertura en frío
 Single lever sink mixer cold start

Box: 1 | Carton: 8 | Pallet: 96

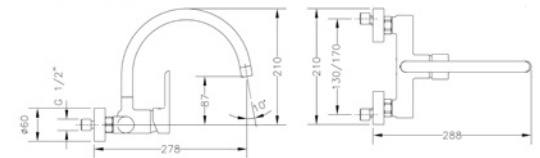
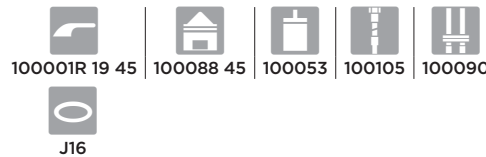

Ref.: 65192 19 45 66
Monomando de fregadera mural 15 cm
 Wall single lever sink mixer 15 cm

Box: 1 | Carton: 6 | Pallet: 54



serie Klip | Acabado cromado | Chromed finish

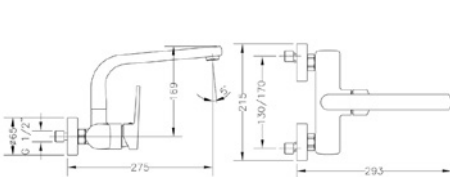

Ref.: 64192 16 45 66
Monomando de fregadera mural
 Wall single lever sink mixer

Box: 1 | Carton: 6 | Pallet: 72

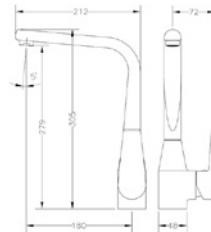
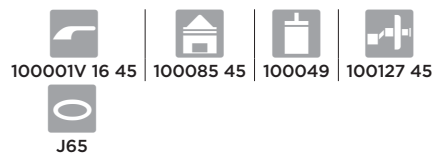

Ref.: 64201 16 45 66
Monomando de fregadera
 Single lever sink mixer

Box: 1 | Carton: 8 | Pallet: 144

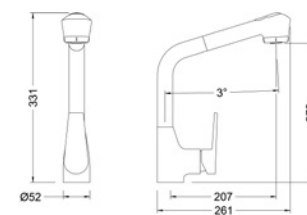
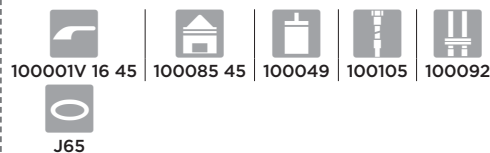

Ref.: 64206 16 45 66
Monomando de fregadera ducha extraíble
 Single lever sink mixer with pull-out spray

Box: 1 | Carton: 6 | Pallet: 108

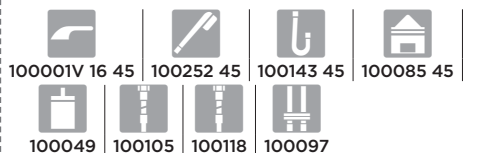

serie Kelogic | Acabado cromado | Chromed finish

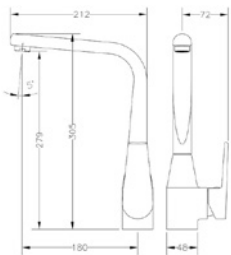

Ref.: 64201 04 45 66

Monomando de fregadera apertura frío

Single lever sink mixer cold start

Box: 1 | Carton: 6 | Pallet: 108



100001R 16 45 | 100074 45 | 100048 | 100105 | 100092 | J65

serie Tau | Acabado cromado | Chromed finish

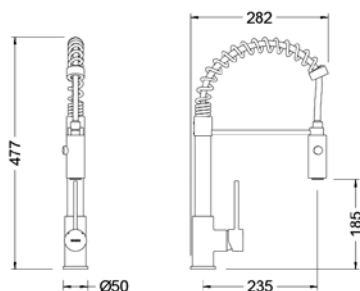

Ref.: 65211 18 45 66

Monomando de fregadera con muelle

Single lever sink mixer with spring

Box: 1 | Carton: 4 | Pallet: 36

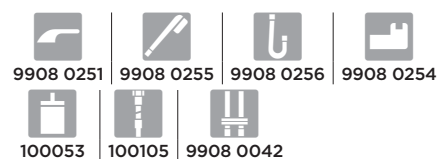

9908 0251 | 9908 0255 | 9908 0256 | 9908 0254
100053 | 100105 | 9908 0042

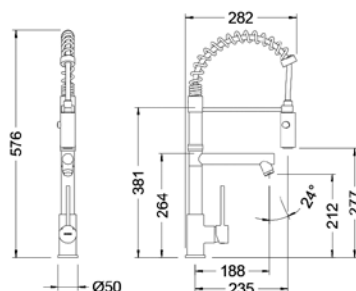

Ref.: 65212 18 45 66

Monomando de fregadera con muelle y caño

Single lever sink mixer with spring and spout

Box: 1 | Carton: 4 | Pallet: 36



9908 0251 | 9908 0255 | 9908 0256 | 9908 0254
9908 0253 | 100085 45 | 100053 | 9908 0252 | 100105
9908 0042 | 9908 0257

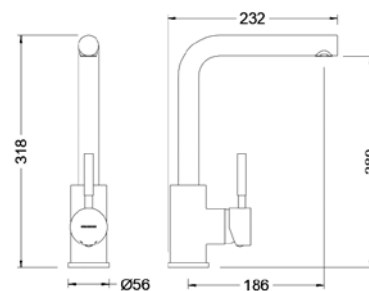

Ref.: 65214 18 45 66

Monomando de fregadera cartucho 40

Single lever sink mixer 40 cartridge

Box: 1 | Carton: 5 | Pallet: 135

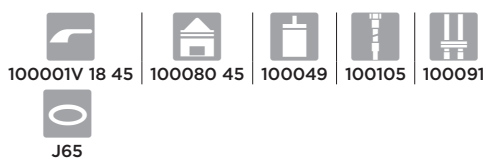

100001V 18 45 | 100080 45 | 100049 | 100105 | 100091
J65

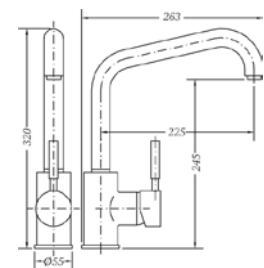

Ref.: 65204 18 45 66

Monomando de fregadera cartucho 40

Single lever sink mixer 40 cartridge

Box: 1 | Carton: 5 | Pallet: 135

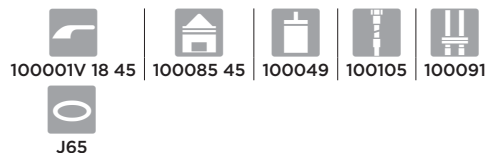

100001V 18 45 | 100085 45 | 100049 | 100105 | 100091
J65

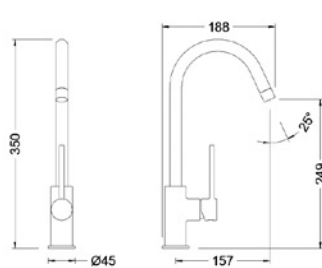

Ref.: 65403 18 45 66

Monomando de fregadera cartucho 25

apertura en frío

Single lever sink mixer 25 cartridge cold start

Box: 1 | Carton: 8 | Pallet: 96

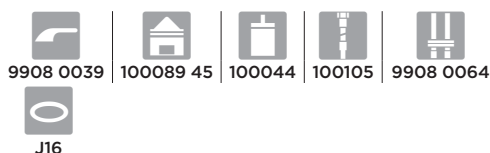

9908 0039 | 100089 45 | 100044 | 100105 | 9908 0064
J16

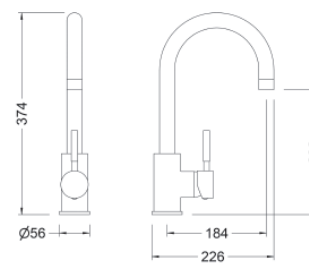

Ref.: 65203 18 45 66

Monomando de fregadera cartucho 40

Single lever sink mixer 40 cartridge

Box: 1 | Carton: 5 | Pallet: 90



100001V 18 45 | 100080 45 | 100049 | 100091 | J65

serie Tau | Acabado cromado | Chromed finish

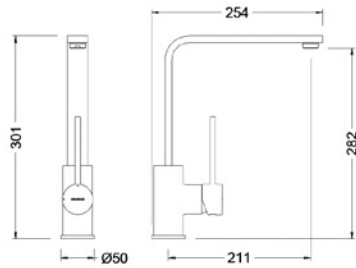

Ref.: 65404 18 45 66
Monomando de fregadera cartucho 35 apertura en frío
 Single lever sink mixer 35 cartridge cold start
Box: 1 | Carton: 8 | Pallet: 96

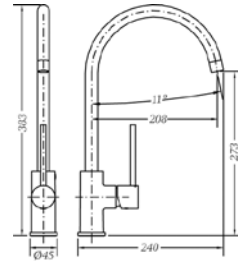

Ref.: FRT65401
Monomando de fregadera cartucho 25 apertura en frío
 Single lever sink mixer 25 cartridge cold start

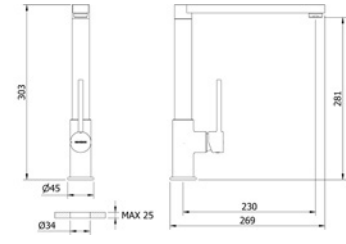
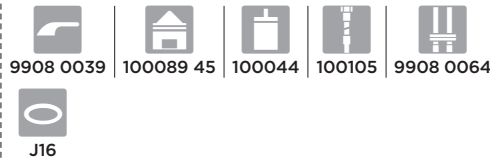

Ref.: 65215 18 45 66
Monomando de fregadera cartucho 25 apertura en frío Tau
 Tau Single lever sink mixer 25 cartridge cold start

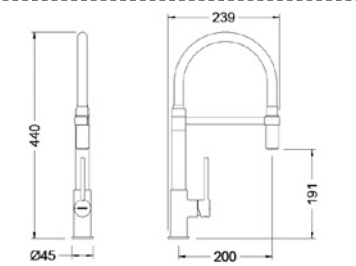
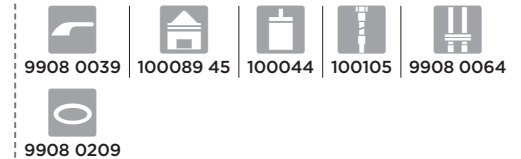

Ref.: 65219 18 45 66
Monomando de fregadera cartucho 25 apertura en frío
 Single lever sink mixer 25 cartridge cold start
Box: 1 | Carton: 4 | Pallet: 48

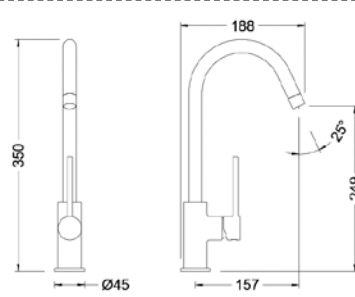

Ref.: 65403 18 45 66
Monomando de fregadera cartucho 25 apertura en frío
 Single lever sink mixer 25 cartridge cold start
Box: 1 | Carton: 8 | Pallet: 96

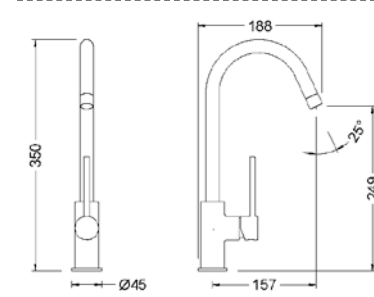

Ref.: 65403 18 40 66
Monomando de fregadera cartucho 25 apertura en frío Tau Blanca
 Tau White Single lever sink mixer 25 cartridge cold start

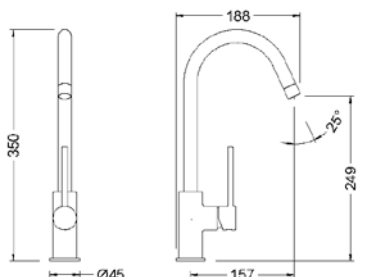
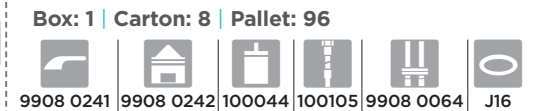

Ref.: 65403 18 41 66
Monomando de fregadera cartucho 25 apertura en frío Tau Black
 Tau Black Single lever sink mixer 25 cartridge cold start

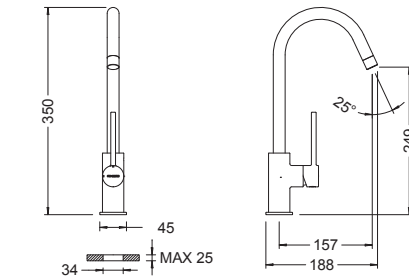
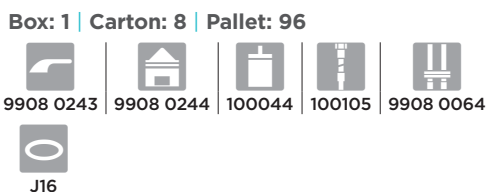

Ref.: 65403 18 44 66
Monomando de fregadera Tau acabado Acero Inoxidable cartucho 25 apertura en frío
 Tau Stainless steel finish single lever sink mixer 25 cartridge cold start

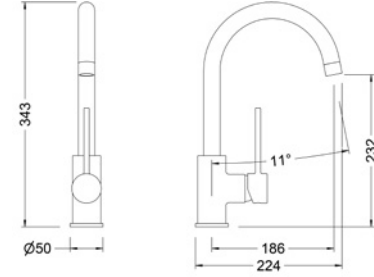
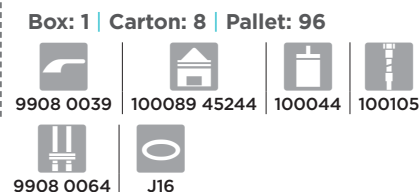

Ref.: FRT65402
Monomando de fregadera cartucho 35 apertura en frío
 Single lever sink mixer 35 cartridge cold start
Box: 1 | Carton: 8 | Pallet: 96

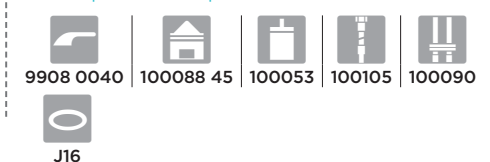

serie Tau | Acabado cromado | Chromed finish

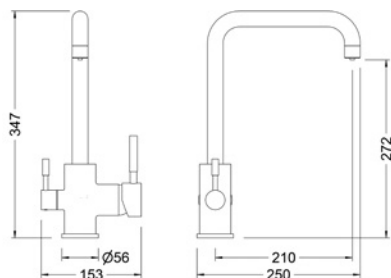

Ref.: 65702 18 45 66
Monomando de fregadera 3 vías apertura en frío
 Single lever 3-way sink mixer cold start
Box: 1 | Carton: 4 | Pallet: 96

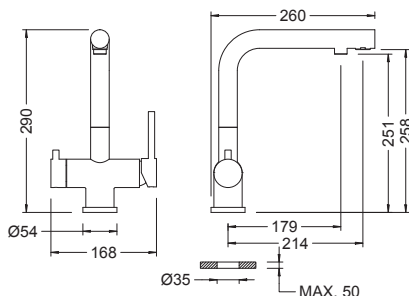
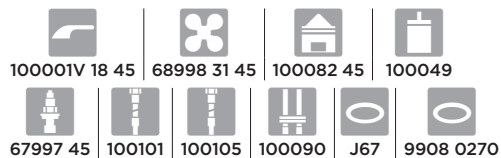

Ref.: 65703 18 60 66
Monomando de fregadera inox 3 vías
 Stainless steel single lever 3-way sink mixer
Box: 1 | Carton: 4 | Pallet: 48

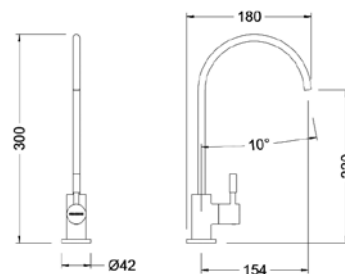

Ref.: 65700 18 45 66
Grifo de 1 vía
 One way tap
Box: 1 | Carton: 14 | Pallet: 252

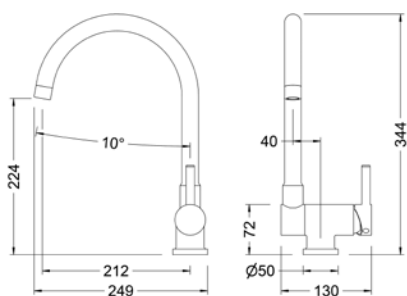

Ref.: 65900 18 45 66
Monomando de fregadera abatible cartucho 35 apertura en frío
 Single lever folding sink mixer 35 cartridge cold start
Box: 1 | Carton: 8 | Pallet: 96

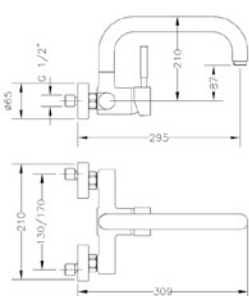
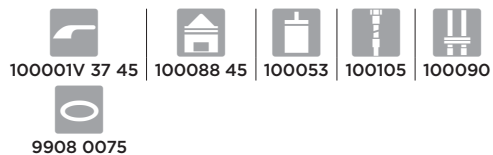

Ref.: 65192 18 45 66
Monomando de fregadera mural 15 cm
 Wall single lever sink mixer 15 cm
Box: 1 | Carton: 4 | Pallet: 72

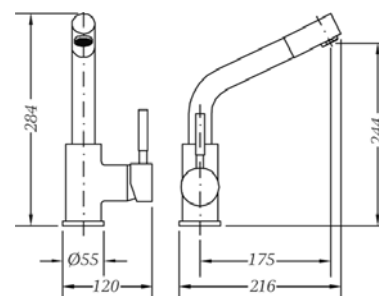

Ref.: 65206 18 45 66
Monomando de fregadera caño extraíble
 Single lever sink mixer with pull-out spout
Box: 1 | Carton: 8 | Pallet: 192

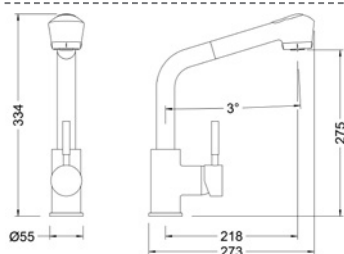
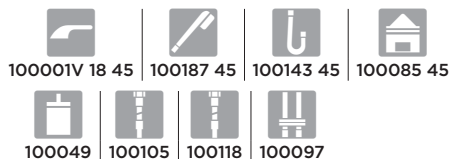

Ref.: 65205 18 45 66
Monomando de fregadera ducha extraíble
 Single lever sink mixer with pull-out spray
Box: 1 | Carton: 6 | Pallet: 108

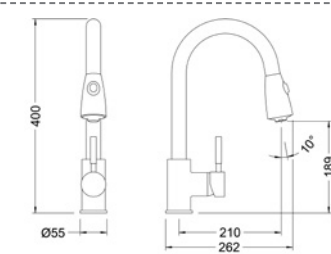
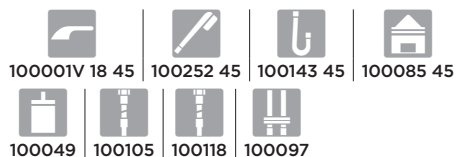

Ref.: FRV61205
Monomando de fregadera ducha extraíble
 Single lever sink mixer with pull-out spray
Box: 1 | Carton: 4 | Pallet: 72

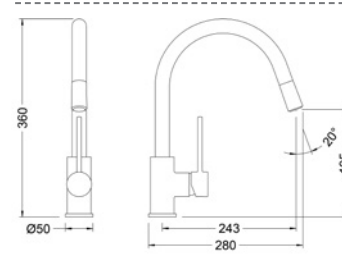
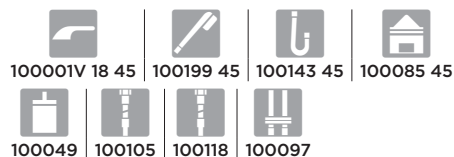

Ref.: FRV61206
Monomando de fregadera caño extraíble
 Single-lever sink mixer with pull-out spout
Box: 1 | Carton: 4 | Pallet: 48



serie Tau | Acabado cromado | Chromed finish

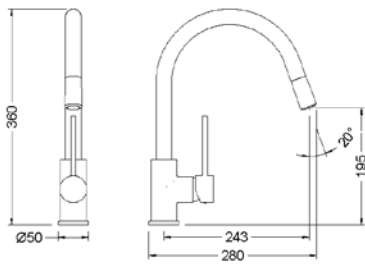

Ref.: FRV61206
Monomando de fregadera caño extraíble Tau
 Tau Single-lever sink mixer with pull-out spout

Box: 1 | Carton: 4 | Pallet: 36

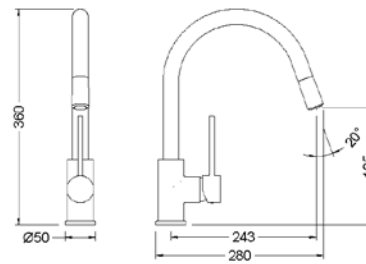
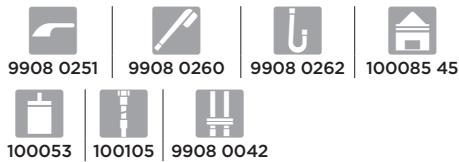

Ref.: FRV61207 40
Monomando de fregadera caño extraíble Tau
 Tau Single-lever sink mixer with pull-out spout

Box: 1 | Carton: 4 | Pallet: 36

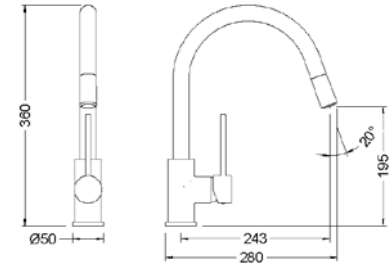
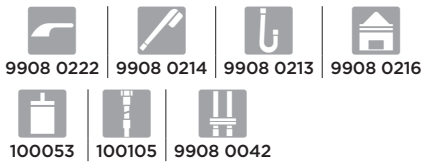

Ref.: FRV61207 41
Monomando de fregadera caño extraíble Tau
 Tau Single-lever sink mixer with pull-out spout

Box: 1 | Carton: 4 | Pallet: 36

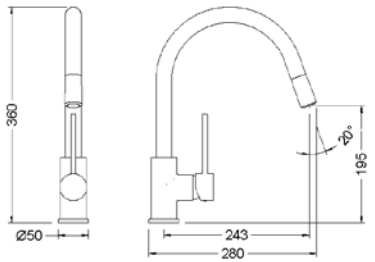

Ref.: FRV61207 44
Monomando de fregadera caño extraíble acabado Acero Inoxidable Tau
 Tau Stainless steel finish single-lever sink mixer with pull-out spout

Box: 1 | Carton: 4 | Pallet: 36

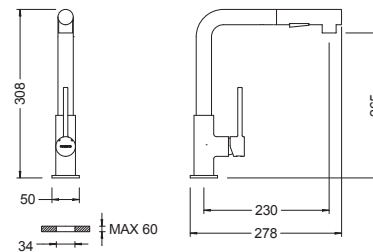
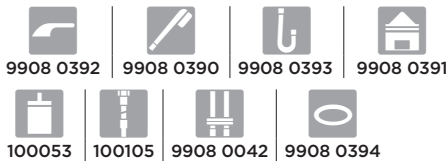

Ref.: FRV61208 41
Monomando de fregadera caño extraíble Tau Negra
 Tau Black single-lever sink mixer with pull-out spout

Box: 1 | Carton: 4 | Pallet: 36

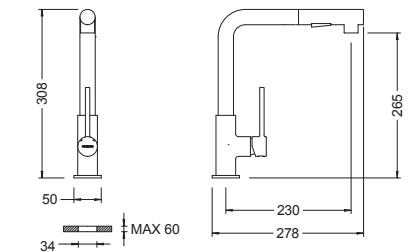

Ref.: FRV61208 44
Monomando de fregadera caño extraíble acabado Acero Inoxidable Tau
 Tau Stainless steel finish single-lever sink mixer with pull-out spout

Box: 1 | Carton: 4 | Pallet: 36

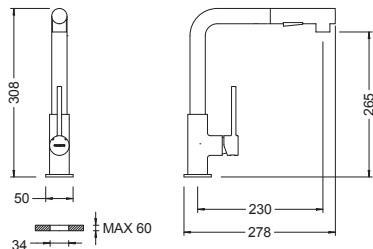
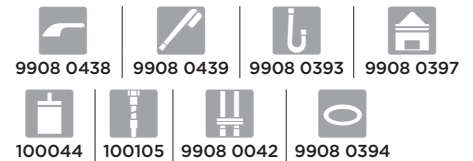

Ref.: FRV61208 45
Monomando de fregadera caño extraíble Tau
 Tau Single-lever sink mixer with pull-out spout

Box: 1 | Carton: 4 | Pallet: 36

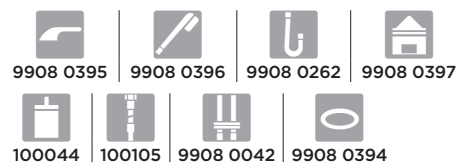

serie Kenjo | Acabado cromado | Chromed finish

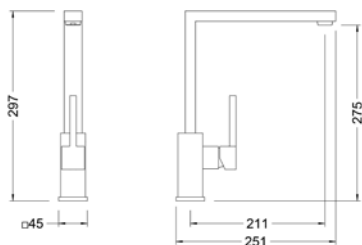

Ref.: FRK63400
Monomando de fregadera cartucho 25
 Single lever sink mixer 25 cartridge

Box: 1 | Carton: 8 | Pallet: 96



J65

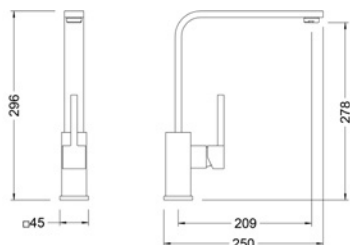

Ref.: FRK63401
Monomando de fregadera cartucho 25
 Single lever sink mixer 25 cartridge

Box: 1 | Carton: 8 | Pallet: 96



J65

serie Inox | Acabado cromado | Chromed finish

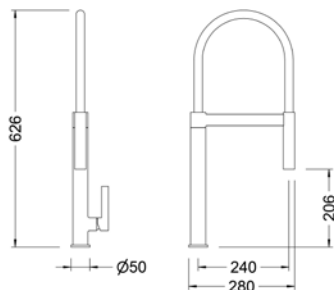

Ref.: 65219 40 60 66
Monomando de fregadera inox cartucho 25
 Stainless steel single lever sink mixer 25 cartridge

Box: 1 | Carton: 4 | Pallet: 36

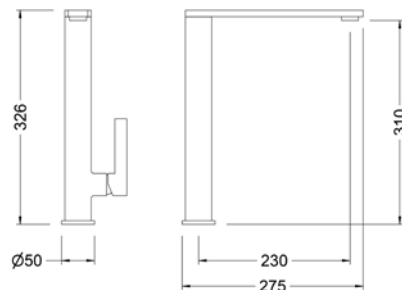

Ref.: 65215 40 60 66
Monomando de fregadera inox cartucho 25
 Stainless steel single lever sink mixer 25 cartridge

Box: 1 | Carton: 4 | Pallet: 48

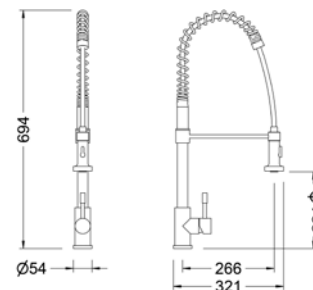

Ref.: 65211 18 60 66
Monomando de fregadera inox con muelle
 Stainless steel single lever sink mixer with spring

Box: 1 | Carton: 4 | Pallet: 36



J20

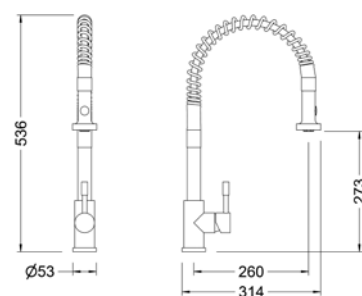

Ref.: 65207 18 60 66
Monomando de fregadera inox con muelle y ducha extraíble
 Stainless steel single lever sink mixer with spring and pull-out sprayer

Box: 1 | Carton: 4 | Pallet: 36



100053 | 100100

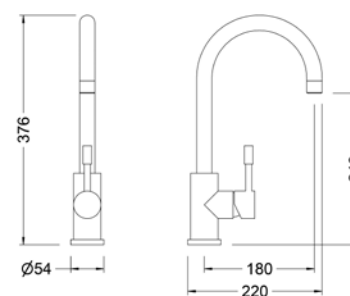

Ref.: 65203 18 60 66
Monomando de fregadera inox caño cisne
 Stainless steel single lever sink mixer with swan pipe

Box: 1 | Carton: 5 | Pallet: 60



100001V 18 60 | 9908 0043 | 100053 | 100100 | J18

serie K8 | Acabado cromado | Chromed finish

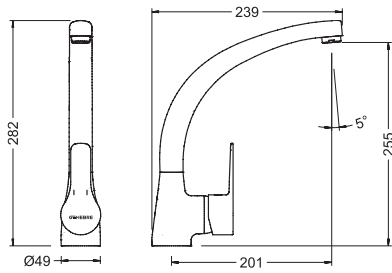

Ref.: 61201 28 45 66
Monomando de fregadera caño fundido
 Single lever sink mixer casted spout

Box: 1 | Carton: 8 | Pallet: 192

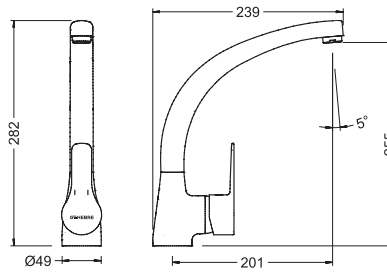
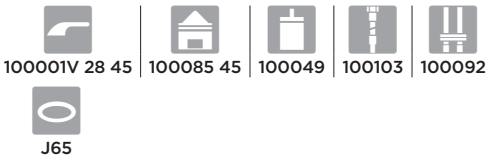

Ref.: 61203 28 45 66
Monomando de fregadera caño conformado
 Single-lever sink mixer tube spout

Box: 1 | Carton: 8 | Pallet: 192

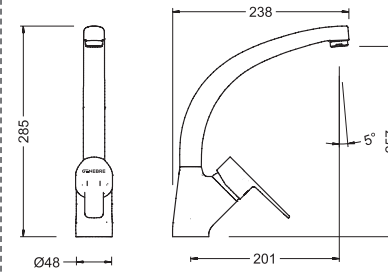

Ref.: 61204 28 45 66
Monomando de fregadera caño conformado
 Single-lever sink mixer tube spout

Box: 1 | Carton: 8 | Pallet: 144

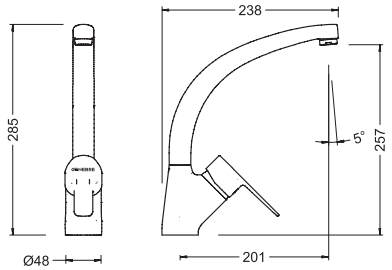
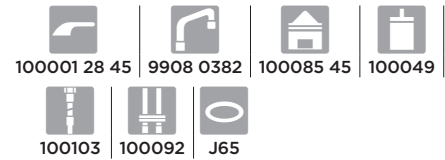

Ref.: 61210 28 45 66
Monomando de fregadera caño fundido
 Single lever sink mixer casted spout

Box: 1 | Carton: 8 | Pallet: 144

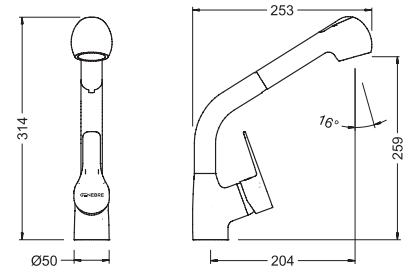
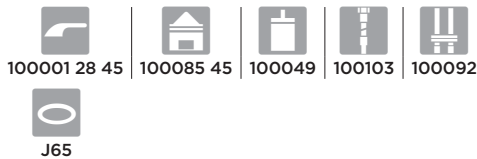

Ref.: 61206 28 45 66
Monomando de fregadera ducha extraíble
 Single-lever sink mixer with pull-out spray

Box: 1 | Carton: 10 | Pallet: 180

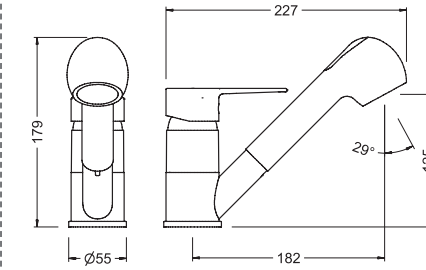
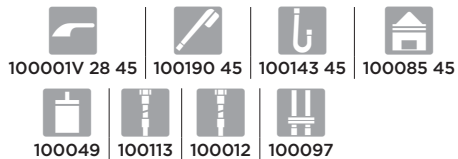

Ref.: 61205 28 45 66
Monomando de fregadera ducha extraíble
 Single lever sink mixer with pull-out spray

Box: 1 | Carton: 10 | Pallet: 180

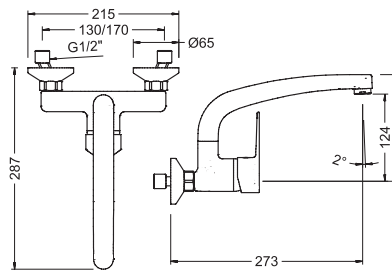
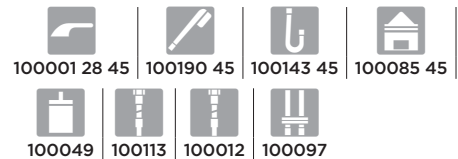

Ref.: 61192 28 45 66
Monomando de fregadera mural 15 cm
 Wall single-lever sink mixer 15 cm

Box: 1 | Carton: 6 | Pallet: 144

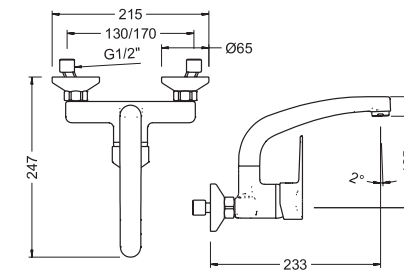

Ref.: 61190 28 45 66
Monomando de fregadera mural 15 cm caño corto
 Wall single lever sink mixer 15 cm short spout

Box: 1 | Carton: 6 | Pallet: 144

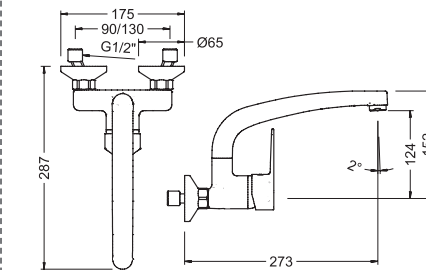
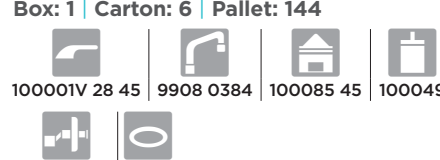

Ref.: 61195 28 45 66
Monomando de fregadera mural 11 cm
 Wall single lever sink mixer 11 cm

Box: 1 | Carton: 6 | Pallet: 144



serie K8 | Acabado cromado | Chromed finish

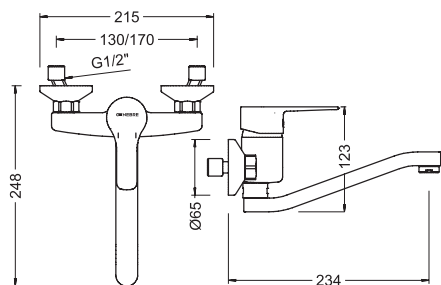

Ref.: 61196 28 45 66
Monomando de fregadera
caño inferior elevado
 Wall single lever sink mixer low spout
Box: 1 | Carton: 8 | Pallet: 192

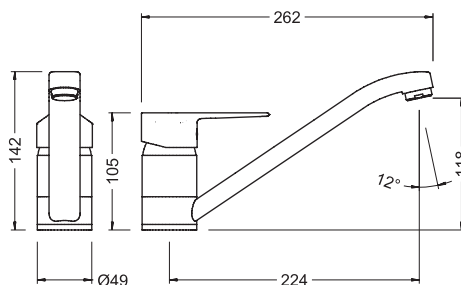
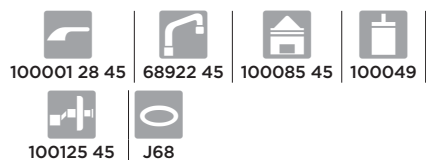

Ref.: 61200 28 45 66
Monomando de fregadera
 Single lever sink mixer
Box: 1 | Carton: 9 | Pallet: 216

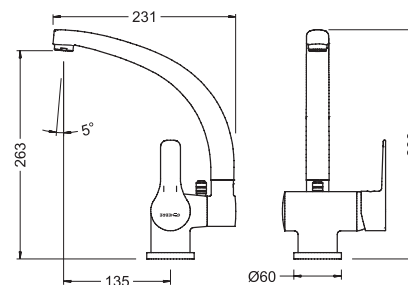

Ref.: 61900 28 45 66
Monomando de fregadera abatible
 Single lever folding sink mixer
Box: 1 | Carton: 6 | Pallet: 108



serie Ge2 | Acabado cromado | Chromed finish

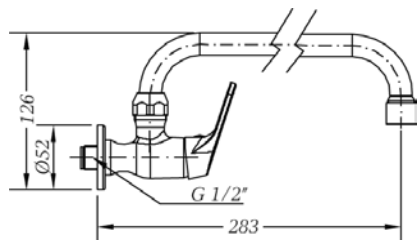

Ref.: 1008 04
Grifo mural con tubo 24 cm 1 agua
cartucho 25
 One-water wall sink tap spout 24 cm
 25 cartridge
Box: 1 | Carton: 30 | Pallet: 540

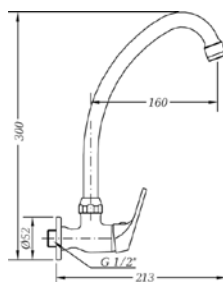

Ref.: 1005 04
Grifo mural con tubo alto 1 agua
cartucho 25
 One-water wall sink tap high spout
 25 cartridge
Box: 1 | Carton: 30 | Pallet: 540

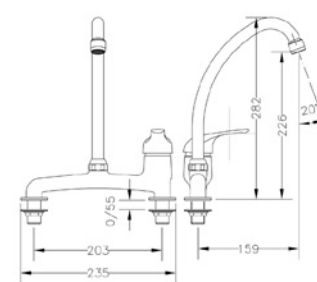

Ref.: 60198 05 45 66
Monomando mesada 8"
 8" widespread single lever sink mixer
Box: 1 | Carton: 6 | Pallet: 144

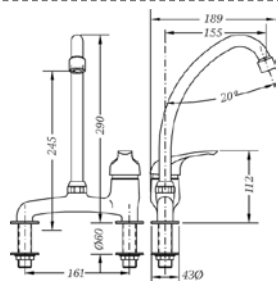

Ref.: 60199 05 45 66
Monomando mesada 16cm
 16cm widespread single lever sink mixer
Box: 1 | Carton: 10 | Pallet: 240

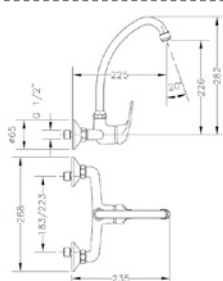
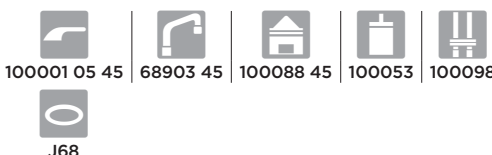

Ref.: 60194 05 45 66
Monomando de fregadera mural 8"
 Wall single lever 8" sink mixer
Box: 1 | Carton: 6 | Pallet: 216

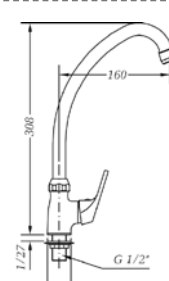

Ref.: 1009 04
Grifo fregadera 1 agua cartucho 25
 One-water sink tap 25 cartridge
Box: 1 | Carton: 30 | Pallet: 540



serie New Regent Classic | Montura 1/4 vuelta cierre cerámico | Ceramic headwork quarter turn

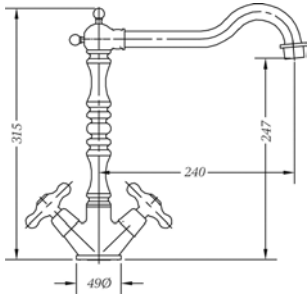

Ref.: 68595 09 45 66
Monobloc de fregadera cromo
Chromed sink mixer

Box: 1 | Carton: 4 | Pallet: 96

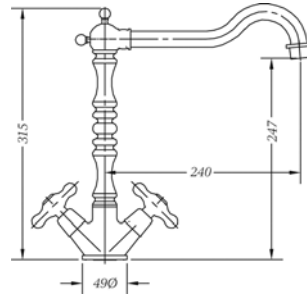

Ref.: 68595 09 43 66
Monobloc de fregadera bronce
Bronze sink mixer

Box: 1 | Carton: 4 | Pallet: 72

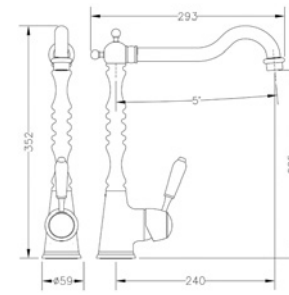

Ref.: 68201 39 45 66
Monomando de fregadera cromo
Chromed sink mixer

Box: 1 | Carton: 4 | Pallet: 96

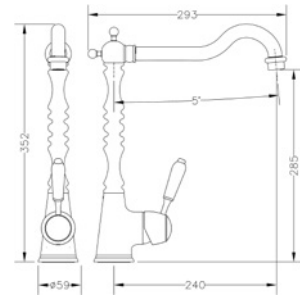

Ref.: 68201 39 43 66
Monomando de fregadera bronce
Bronze sink mixer

Box: 1 | Carton: 4 | Pallet: 96



serie New Regent | Acabado cromado. Montura 1/4 vuelta cierre cerámico | Chromed finish. Ceramic headwork quarter turn

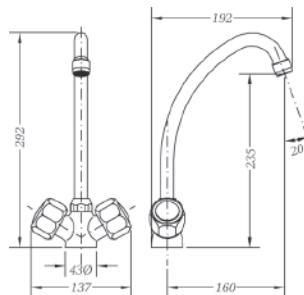

Ref.: 68200 11 45 66
Monobloc fregadera caño tubo
Sink mixer, swan neck spout

Box: 1 | Carton: 10 | Pallet: 240

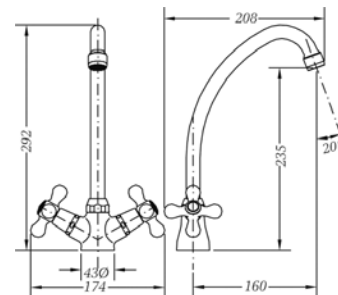

Ref.: 68540 09 45 66
Monobloc fregadera caño tubo
Sink mixer, swan neck spout

Box: 1 | Carton: 10 | Pallet: 240

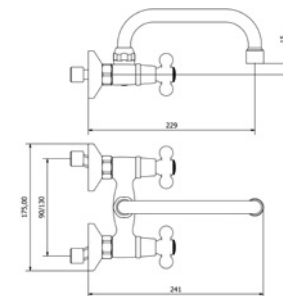

Ref.: 68550 09 45 66
Grupo mural fregadera 11 cm caño tubo alto 18 cm
Wall sink mixer with 11 cm high tube, 18 cm spout

Box: 1 | Carton: 10 | Pallet: 240



serie New Regent | Acabado cromado. Montura 1/4 vuelta cierre cerámico | Chromed finish. Ceramic headwork quarter turn

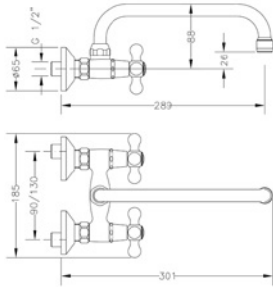

Ref.: 68196 09 45 66
Grupo mural fregadera 11 cm caño tubo alto 24 cm

Wall sink mixer with 11cm high tube, 24 cm spout

Box: 1 | Carton: 10 | Pallet: 270

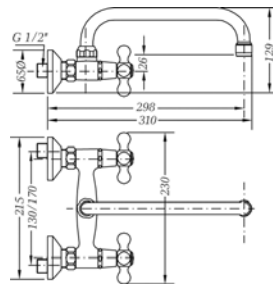
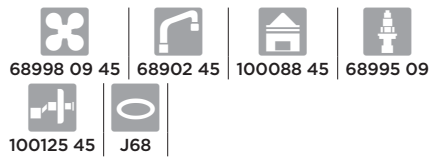

Ref.: 68555 09 45 66
Grupo mural fregadera 15 cm caño tubo alto 24 cm

Wall sink mixer with 15 cm with high tube, 24 cm spout

Box: 1 | Carton: 10 | Pallet: 240

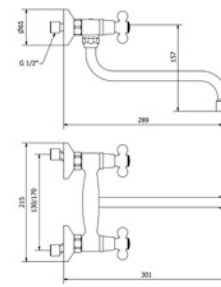
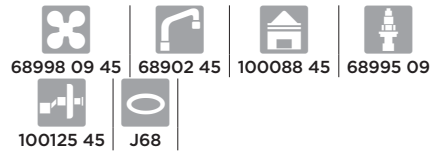

Ref.: 68560 09 45 66
Grupo mural fregadera 15 cm caño tubo bajo 24 cm

Wall sink mixer with 15cm low tube, 24 cm spout

Box: 1 | Carton: 10 | Pallet: 240

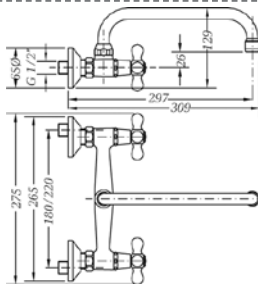

Ref.: 68565 09 45 66
Grupo mural fregadera 20 cm caño tubo alto 24 cm

20 cm wall sink mixer with high tube, 24 cm spout

Box: 1 | Carton: 10 | Pallet: 240

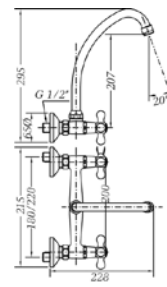
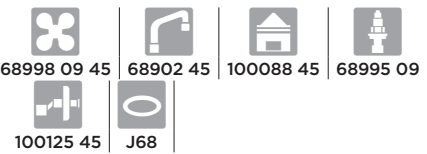

Ref.: 68570 09 45 66
Grupo mural fregadera 20 cm caño tubo alto vertical

20 cm wall sink mixer with swan neck spout

Box: 1 | Carton: 10 | Pallet: 240

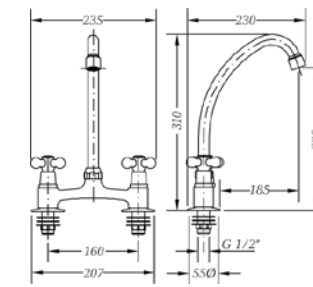
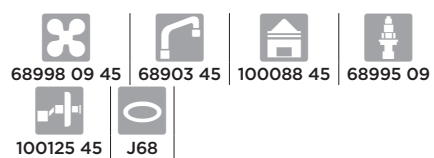

Ref.: 68194 09 45 66
Mezclador mesada 16 cm caño tubo

16 cm deck mixer with swan neck spout

Box: 1 | Carton: 10 | Pallet: 240

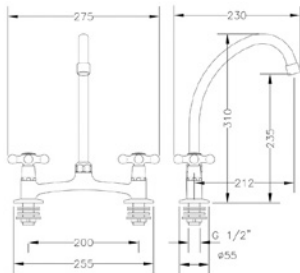
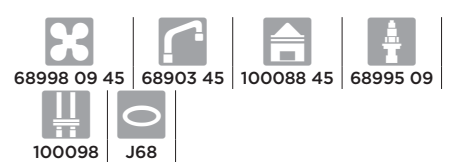

Ref.: 68545 09 45 66
Mezclador mesada 8" caño tubo

8" deck mixer with swan neck spout

Box: 1 | Carton: 10 | Pallet: 240

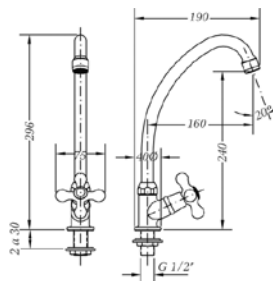
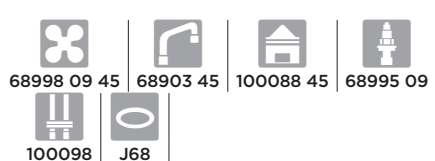

Ref.: 68585 09 45 66
Grifo fregadera encimera caño tubo vertical

Deck sink tap with swan neck spout

Box: 1 | Carton: 10 | Pallet: 240

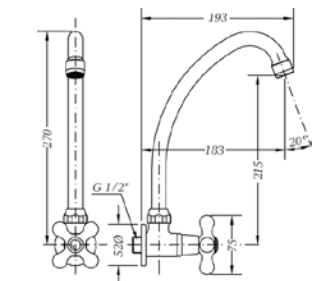
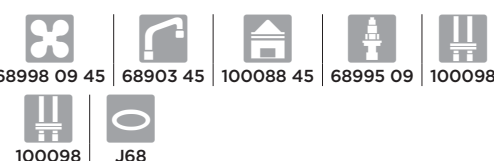

Ref.: 68575 09 45 66
Grifo fregadera mural caño tubo vertical

Wall sink tap with swan neck spout

Box: 1 | Carton: 10 | Pallet: 240

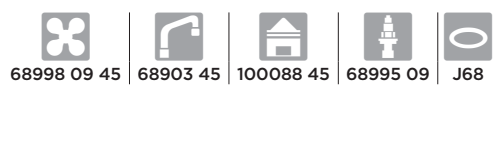

serie New Regent | Acabado cromado. Montura 1/4 vuelta cierre cerámico | Chromed finish. Ceramic headwork quarter turn

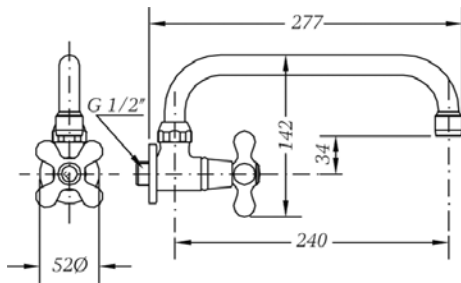

Ref.: 68580 09 45 66
Grifo mural fregadera caño tubo alto 24 cm
 Wall sink tap with tube spout 24 cm

Box: 1 | Carton: 10 | Pallet: 240

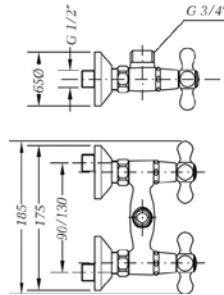

Ref.: 568550 45
Cuerpo grupo mural 11 cm
 Wall body mixer 11 cm

Box: 1 | Carton: 15 | Pallet: 360

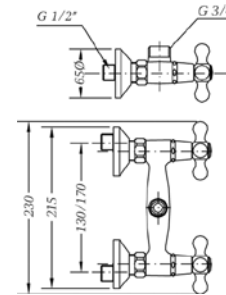

Ref.: 568555 45
Cuerpo grupo mural 15 cm
 Wall body mixer 15 cm

Box: 1 | Carton: 15 | Pallet: 360

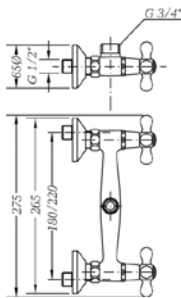

Ref.: 568565 45
Cuerpo grupo mural 20 cm
 Wall body mixer 20 cm

Box: 1 | Carton: 15 | Pallet: 360

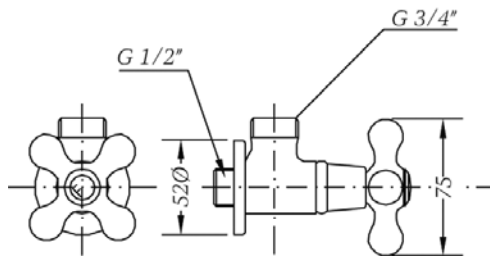

Ref.: 568575 45
Cuerpo grifo mural
 Wall body tap

Box: 1 | Carton: 30 | Pallet: 540

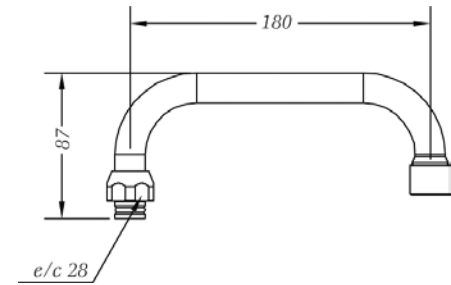

Ref.: 68901 45
Caño alto tubo 18 cm
 High pipe spout 18 cm

Box: 1 | Pallet: 720

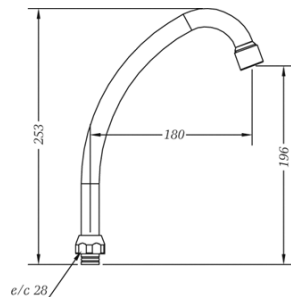

Ref.: 68903 45
Caño tubo vertical
 Vertical pipe spout

Box: 1 | Pallet: 540



serie Gamma | Acabado cromado. Montura convencional | Chromed finish. Conventional headwork

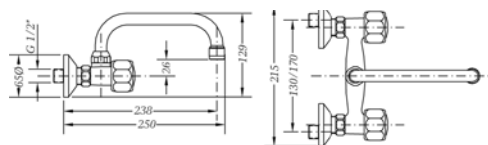

Ref.: 68190 11 45 66
Grupo mural fregadera 15 cm caño tubo alto 18 cm

Wall sink mixer with 15 cm, high tube, 18 cm spout

Box: 1 | Carton: 10 | Pallet: 240

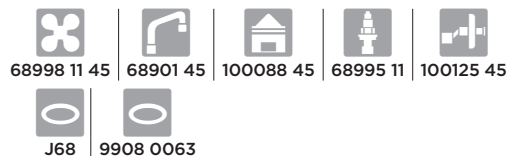

68998 11 45 68901 45 100088 45 68995 11 100125 45

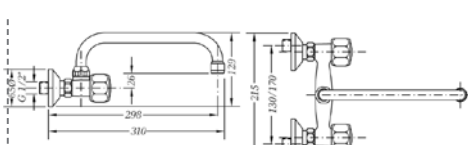

Ref.: 68193 11 45 66
Grupo mural fregadera 15 cm caño tubo alto 24 cm

Wall sink mixer with 15 cm with high tube, 24 cm spout

Box: 1 | Carton: 10 | Pallet: 240

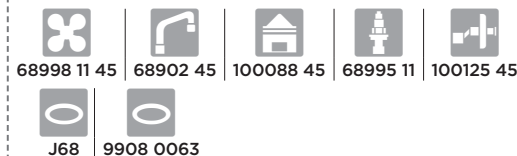

68998 11 45 68902 45 100088 45 68995 11 100125 45

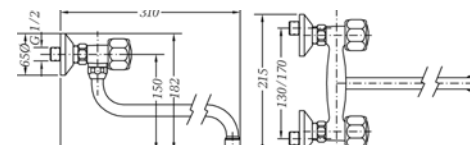

Ref.: 68197 11 45 66
Grupo mural fregadera 15 cm caño tubo bajo 24 cm

Wall sink mixer with 15cm low tube, 24 cm spout

Box: 1 | Carton: 10 | Pallet: 240

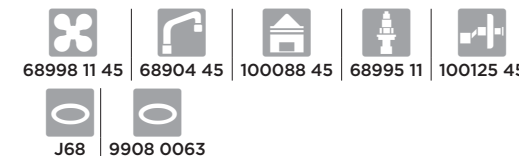

68998 11 45 68904 45 100088 45 68995 11 100125 45

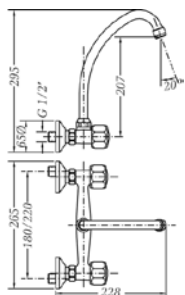

Ref.: 68103 11 45 66
Grupo mural fregadera 20 cm caño tubo alto vertical

20 cm wall sink mixer with swan neck spout

Box: 1 | Carton: 10 | Pallet: 240

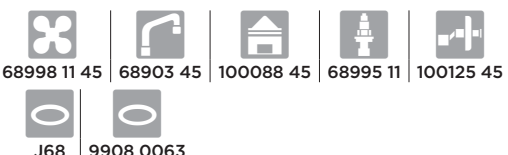

68998 11 45 68903 45 100088 45 68995 11 100125 45

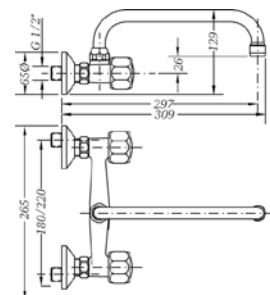

Ref.: 68104 11 45 66
Grupo mural fregadera 20 cm caño tubo alto 24 cm

20 cm wall sink mixer with high tube, 24 cm spout

Box: 1 | Carton: 10 | Pallet: 240

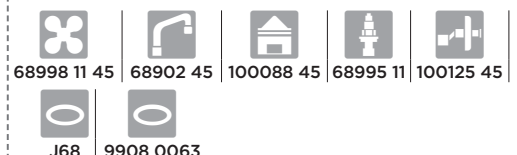

68998 11 45 68902 45 100088 45 68995 11 100125 45

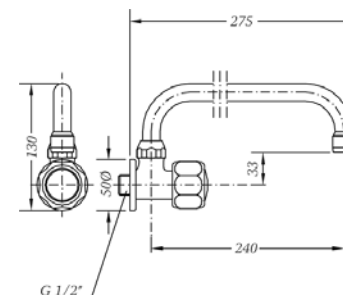

Ref.: 68093 11 45 66
Grifo mural fregadera caño tubo alto 24 cm

Wall sink tap with tube spout 24 cm

Box: 1 | Carton: 10 | Pallet: 240

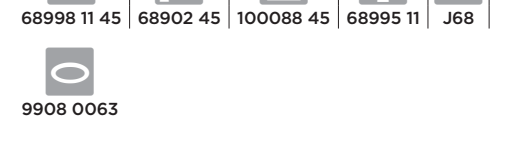

68998 11 45 68902 45 100088 45 68995 11 J68

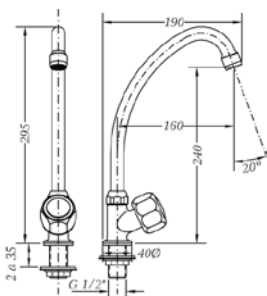

Ref.: 68003 11 45 66
Grifo fregadera encimera caño tubo vertical

Deck sink tap with swan neck spout

Box: 1 | Carton: 10 | Pallet: 240

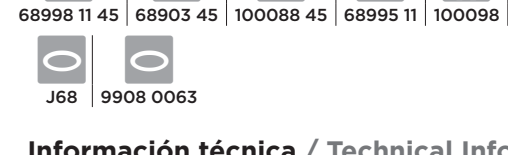

68998 11 45 68903 45 100088 45 68995 11 100098

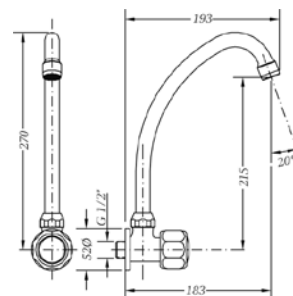

Ref.: 68083 11 45 66
Grifo fregadera mural caño tubo vertical

Wall sink tap with swan neck spout

Box: 1 | Carton: 10 | Pallet: 240

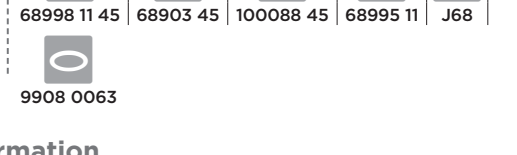

68998 11 45 68903 45 100088 45 68995 11 J68

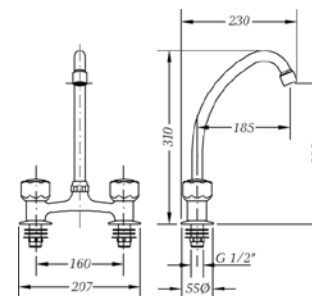

Ref.: 68194 11 45 66
Mezclador mesada 6" caño tubo

6 inch deck mixer with swan neck spout

Box: 1 | Carton: 10 | Pallet: 240

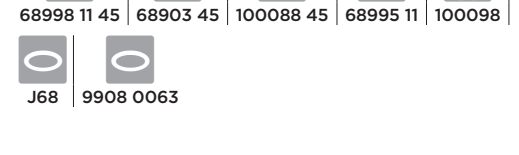

68998 11 45 68903 45 100088 45 68995 11 100098

serie Gamma | Acabado cromado. Montura convencional | Chromed finish. Conventional headwork

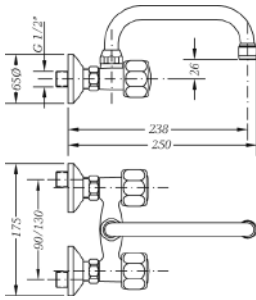

Ref.: 68195 11 45 66
Grupo mural fregadera 11 cm caño tubo alto 18 cm
 Wall sink mixer 11 cm high tube, 18 cm spout

Box: 1 | Carton: 10 | Pallet: 240

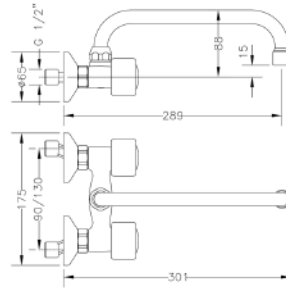
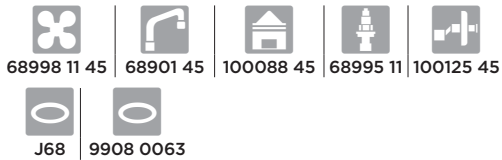

Ref.: 68196 11 45 66
Grupo mural fregadera 11 cm caño tubo alto 24 cm
 Wall sink mixer 11 cm high tube, 24 cm spout

Box: 1 | Carton: 10 | Pallet: 270

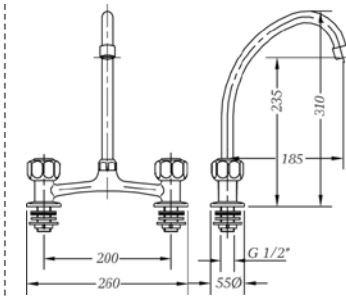
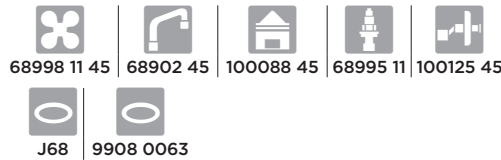

Ref.: 68199 11 45 66
Mezclador mesada 8" caño tubo
 8" deck mixer with swan neck spout

Box: 1 | Carton: 10 | Pallet: 240

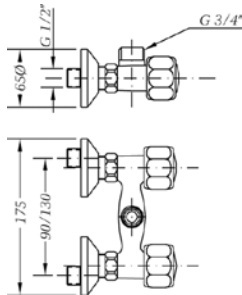
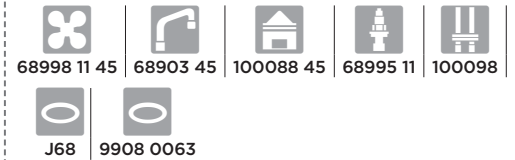

Ref.: 568195 45
Cuerpo grupo mural 11 cm
 Wall body mixer 11 cm

Box: 1 | Carton: 20 | Pallet: 360

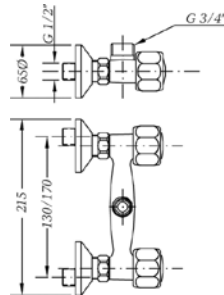

Ref.: 568193 45
Cuerpo grupo mural 15 cm
 Wall body mixer 15 cm

Box: 1 | Carton: 20 | Pallet: 480

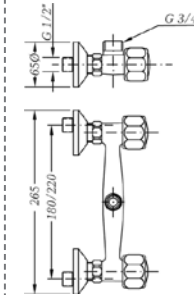

Ref.: 568104 45
Cuerpo grupo mural 20 cm
 Wall body mixer 20 cm

Box: 1 | Carton: 15 | Pallet: 360

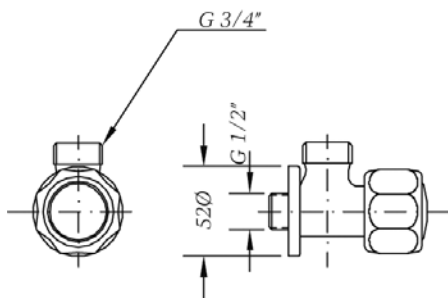

Ref.: 568083 45
Cuerpo grifo mural
 Wall body tap

Box: 1 | Carton: 40 | Pallet: 960

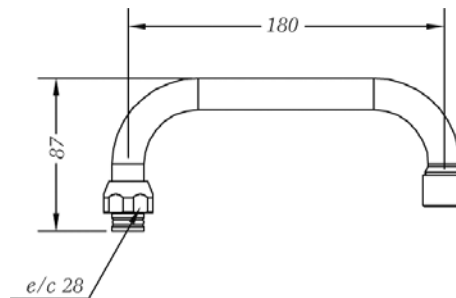

Ref.: 68901 45
Caño alto tubo 18 cm
 High pipe spout 18 cm

Box: 1 | Pallet: 720

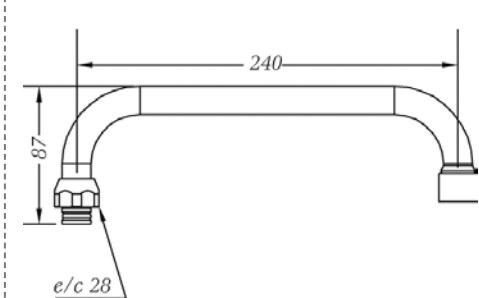

Ref.: 68902 45
Caño alto tubo 24 cm
 High pipe spout 24 cm

Box: 1 | Pallet: 540



serie Gamma | Acabado cromado. Montura convencional | Chromed finish. Conventional headwork

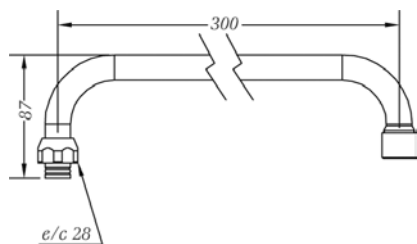

Ref.: 68908 45
Caño alto tubo 30 cm
 High tube spout 30 cm

Box: 1 | Pallet: 720

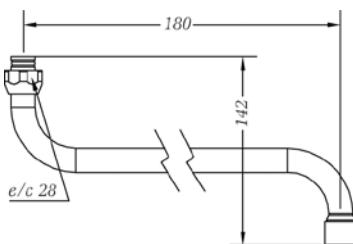

Ref.: 68910 45
Caño bajo tubo 18 cm
 Low tube spout 18 cm

Box: 1 | Pallet: 720

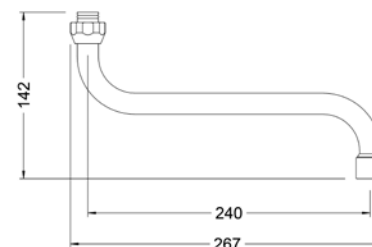

Ref.: 68904 45
Caño bajo tubo 24 cm
 Low tube spout 24 cm

Box: 1 | Pallet: 540

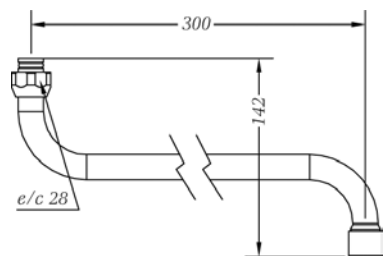

Ref.: 68909 45
Caño bajo tubo 30 cm
 Low tube spout 30 cm

Box: 1 | Pallet: 720

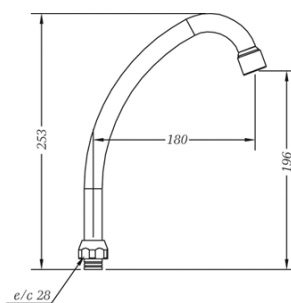

Ref.: 68903 45
Caño tubo vertical
 Vertical pipe spout

Box: 1 | Pallet: 540



serie Accesorios |

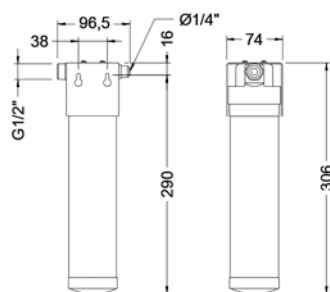

Ref.: FT00
Kit declorador
 Dechlorinator kit

Box: 1 | Carton: 16 | Pallet: 160

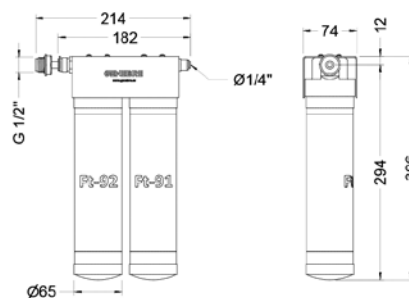

Ref.: FT01
Kit ultrafiltración
 Ultrafiltration kit

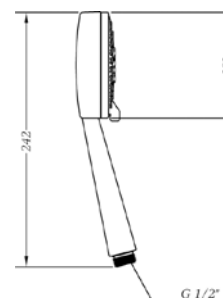

Ref.: DXK3 45
Mango de ducha K3 jets
 K3 jets handshower

Box: 1 | Carton: 36 | Pallet: 324

serie Accesorios |

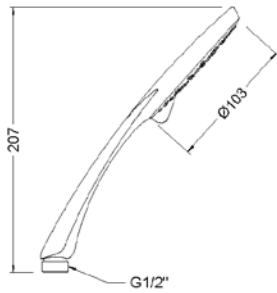

Ref.: 9908 0284
Mango de ducha 3 jets negro
Black 3 jets hand shower

Box: 1 | Carton: 1

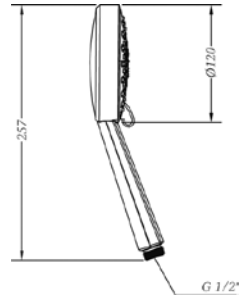

Ref.: DXT5 45
Mango de ducha T5 jets
T5 jets handshower

Box: 1 | Pallet: 288

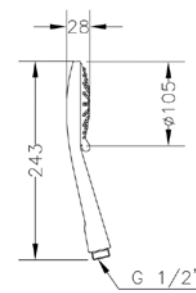

Ref.: DXT3 45
Mango de ducha T3 jets
T3 jets handshower

Box: 1 | Pallet: 324

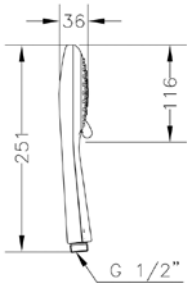

Ref.: DXO3 45
Mango de ducha O3 jets
O3 jets handshower

Box: 1 | Carton: 36 | Pallet: 324

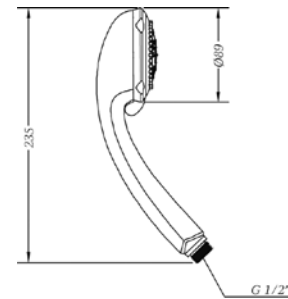

Ref.: DXE5 45
Mango de ducha E5 jets
E5 jets handshower

Box: 1 | Carton: 45 | Pallet: 405

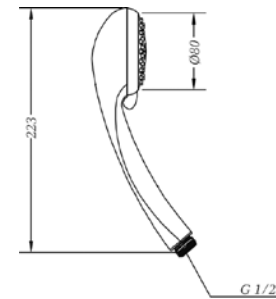

Ref.: DXE2 45
Mango de ducha E2 jets
E2 jets handshower

Box: 1 | Carton: 45 | Pallet: 540

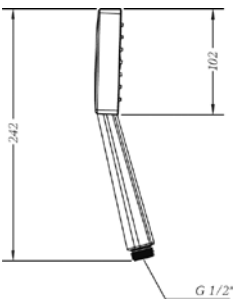

Ref.: DXK1 45
Mango de ducha K1 jets
K1 jet handshower

Box: 1 | Carton: 36 | Pallet: 324

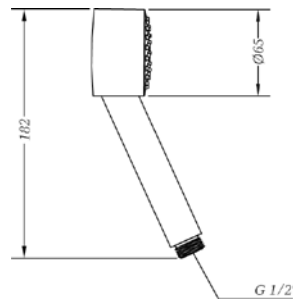

Ref.: 100197 45 00
Mango de ducha C1 jet
C1 jet handshower

Box: 1 | Carton: 100 | Pallet: 1200

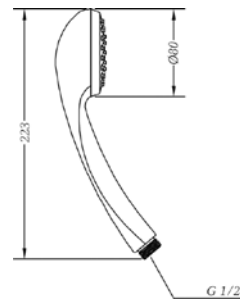

Ref.: 100175 45 00
Mango de ducha E1 jet
E1 jet handshower

Box: 1 | Carton: 60 | Pallet: 1080

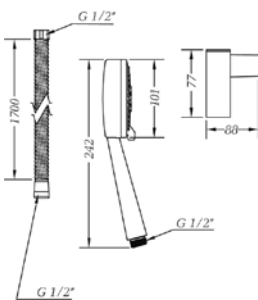

Ref.: 100698 45
Kit de ducha Kenjo, flexo, soporte y ducha
3 jets

Kenjo shower set, flexible hose, holder and 3 jets handshower

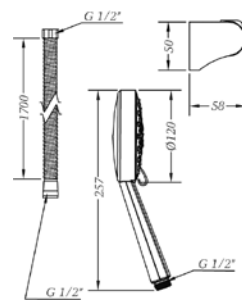

Ref.: 100699 45
Kit de ducha Tau, flexo, soporte y ducha
5 jets

Tau shower set, flexible hose, holder and 5 jets handshower

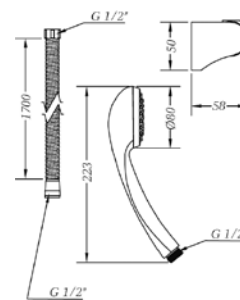

Ref.: 100697 45
Kit de ducha GE2, flexo, soporte y ducha
1 jet

GE2 shower set, flexible hose, holder and 1 jet handshower

serie Accesorios |

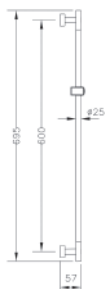

Ref.: 1637 45
Barra ducha Kenjo
Kenjo shower bar

Box: 1 | Carton: 10 | Pallet: 60

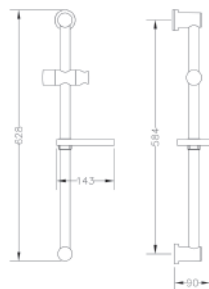

Ref.: 1638 45
Barra ducha redonda
Round shower bar

Box: 1 | Carton: 10 | Pallet: 100

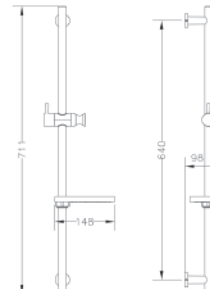

Ref.: 1639 45
Barra ducha metálica
Round shower bar Metallic

Box: 1 | Carton: 8 | Pallet: 48

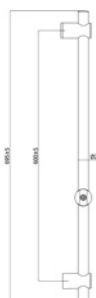

Ref.: 1748 45
Conjunto Tau, barra, flexo y ducha 5 jets
Tau set, bar, hose and 5 jets handshower

Box: 1 | Carton: 10 | Pallet: 60

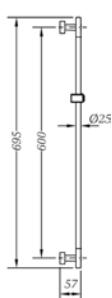

Ref.: 1747 45
Conjunto Kenjo, barra, flexo y ducha 3 jets
Kenjo set, bar, flexible hose and 3 jets handshower

Box: 1 | Carton: 10 | Pallet: 60

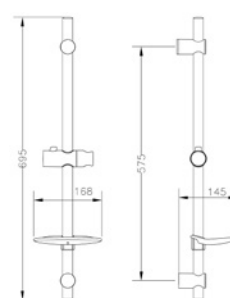

Ref.: 1636 45
Barra ducha TAU
TAU shower bar

Box: 1 | Carton: 10 | Pallet: 90

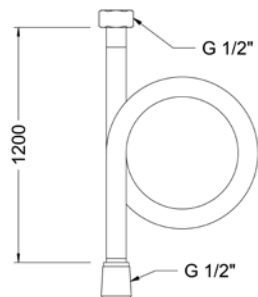

Ref.: 100141 45
Flexo H 1/2" - H 1/2" 1,20 m inoxidable
F 1/2" - F 1/2" Stainless steel flexible hose 1.20 m

Box: 1 | Carton: 50 | Pallet: 900

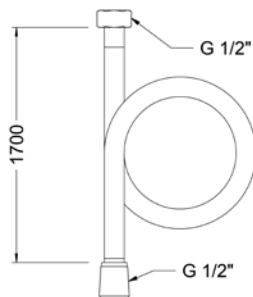

Ref.: 100135 60 00
Flexo H 1/2" - H 1/2" 1,70 m inoxidable
F 1/2" - F 1/2" Stainless steel flexible hose 1.70 m

Box: 1 | Carton: 50 | Pallet: 900

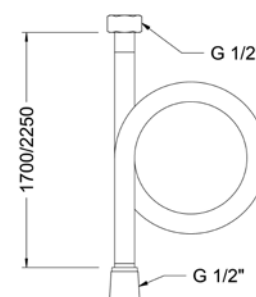

Ref.: 100137 60 00
Flexo extensible H 1/2" - H 1/2" 1,70 - 2,25 m inoxidable
F 1/2" - F 1/2" Extensible stainless steel flexible hose 1.70 to 2.25 m

Box: 1 | Carton: 50 | Pallet: 900

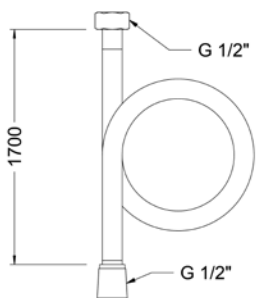

Ref.: 100140 30
Flexo H 1/2" - H 1/2" 1,70 m. PVC antirrotura
F 1/2" - F 1/2" PVC flexible hose 1.70 m anti-breaking

Box: 1 | Carton: 24 | Pallet: 432

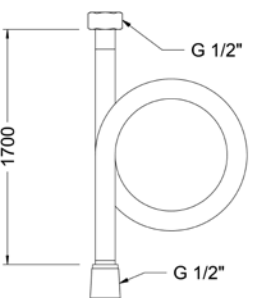

Ref.: 9908 0287
Flexo H 1/2" - H 1/2" 1,70 m inoxidable negro
F 1/2" - F 1/2" Black stainless steel flexible hose 1.70 m

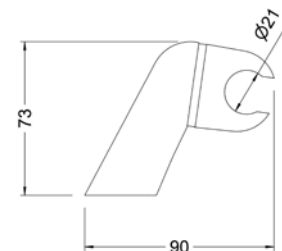

Ref.: 100152 45 00
Soporte ducha
Shower holder

Box: 1 | Carton: 150 | Pallet: 1800

Información técnica / Technical Information

serie Accesorios |

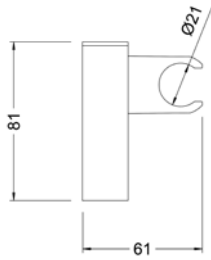

Ref.: 100149 45
Soporte ducha Kenjo
Kenjo shower holder

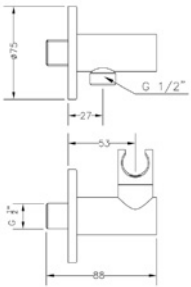

Ref.: 1633 04
Soporte de ducha orientable cilíndrico con toma 1/2"
Orientable cylindrical shower holder with 1/2" connector
Box: 1 | Carton: 75 | Pallet: 1800

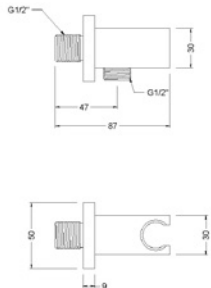

Ref.: 1635 04
Soporte de ducha cuadrado con toma 1/2"
Square shower holder with 1/2" connector
Box: 1 | Carton: 1

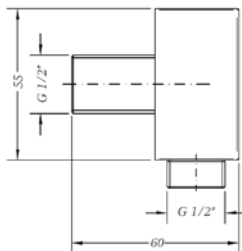

Ref.: 1679 04
Toma ducha mural cuadrada
Square wall connector
Box: 1 | Carton: 40 | Pallet: 2304

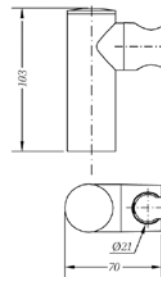

Ref.: 100153 45
Soporte ducha cilíndrico
Cylindrical shower holder

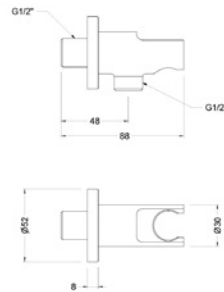

Ref.: 1634 04
Soporte de ducha cilíndrico con toma 1/2"
Cylindrical shower holder with 1/2" connector
Box: 1 | Carton: 1

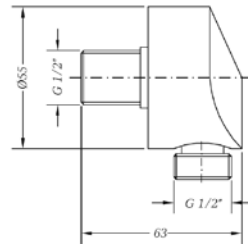

Ref.: 1680 04
Toma ducha mural redonda
Round wall connector
Box: 1 | Carton: 40 | Pallet: 2304

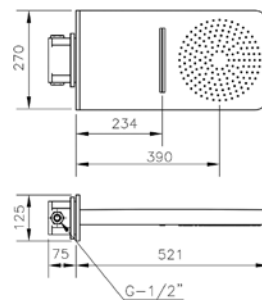

Ref.: 1643 45
Rociador doble función cascada-lluvia
Shower head double function waterfall-rain
Box: 1 | Carton: 2 | Pallet: 12

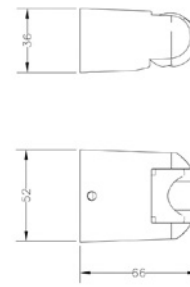

Ref.: 100068 45
Soporte ducha ovalado
Oval shower holder

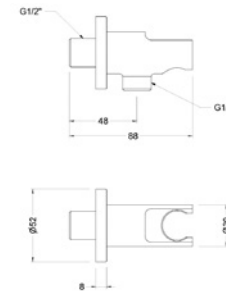

Ref.: 1946 41
Soporte de ducha cilíndrico con toma 1/2" Negro
Black Cylindrical shower holder with 1/2" connector
Box: 1 | Carton: 1

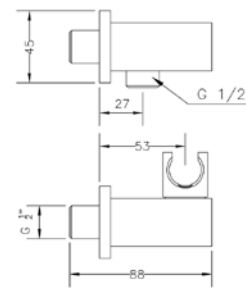

Ref.: 1649 04
Soporte de ducha orientable cuadrado con toma 1/2"
Orientable square shower holder with 1/2" connector
Box: 1 | Carton: 50 | Pallet: 1600

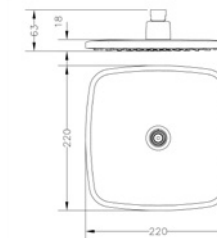

Ref.: R63112 08
Rociador D22 ovalado
Oval D22 shower sprayer
Box: 1 | Carton: 24 | Pallet: 192

serie Accesorios |

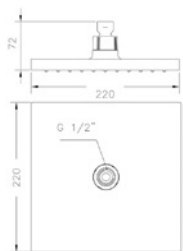

Ref.: R63112 26
Rociador cuadrado 22 cm
 Square shower head 22 cm
Box: 1 | Carton: 24 | Pallet: 144

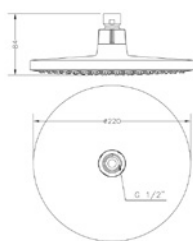

Ref.: R65112 18
Rociador redondo 22 cm
 Round shower head Ø 22 cm
Box: 1 | Carton: 24 | Pallet: 144

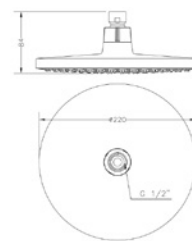

Ref.: R65112 41
Rociador D22 Oslo Black
 Oslo Black D22 shower head
Box: 1 | Carton: 1

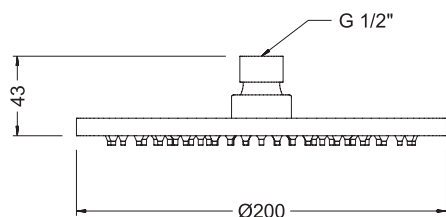

Ref.: R68113 43
Rociador redondo 20cm Bronze
 Bronze round shower head 20cm
Box: 1 | Carton: 1

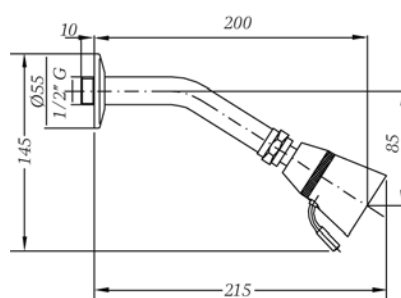

Ref.: 1698 45 00
Rociador ducha con brazo
 Wall shower arm and spray
Box: 1 | Carton: 15 | Pallet: 480

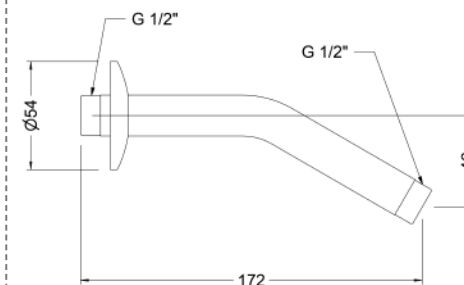

Ref.: 1699 45 00
Brazo pared redondo 12 cm
 Round wall arm 12 cm
Box: 5 | Carton: 75 | Pallet: 2700

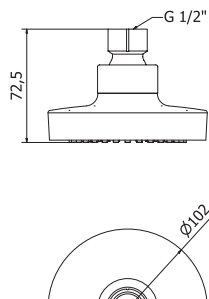

Ref.: 1155 04
Rociador cilíndrico 10cm
 Cylindrical shower head 10cm
Box: 1 | Carton: 48 | Pallet: 864

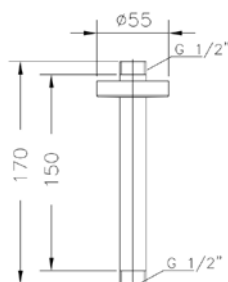

Ref.: 1671 45
Brazo a techo redondo 15 cm
 Round roof arm 15 cm
Box: 1 | Carton: 20 | Pallet: 600

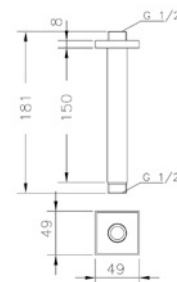

Ref.: 1672 45
Brazo a techo cuadrado 15 cm
 Square roof arm 15 cm
Box: 1 | Carton: 20 | Pallet: 800

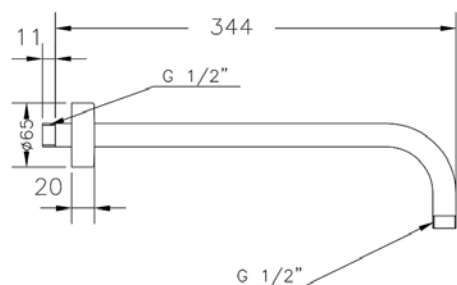

Ref.: B65113 18
Brazo pared redondo 35 cm
 Round wall arm 35 cm
Box: 1 | Carton: 20 | Pallet: 600

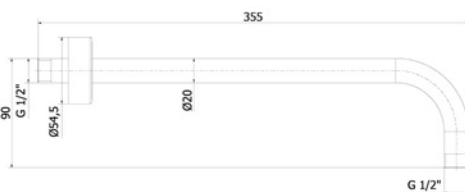

Ref.: B64113 41
Brazo pared redondo 35 cm negro
 Black round wall arm 35 cm
Box: 1 | Carton: 20 | Pallet: 600

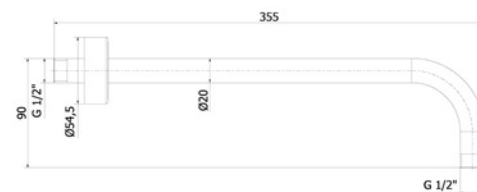

Ref.: B64113 43
Brazo pared redondo 35cm Bronze
 Bronze round wall arm 35cm
Box: 1 | Carton: 1

serie Accesorios |

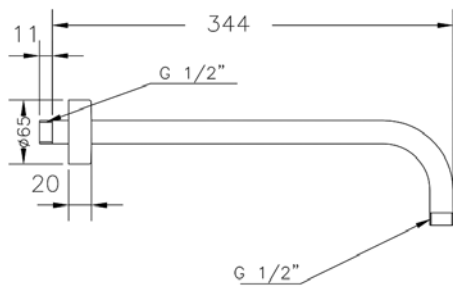

Ref.: B65114 18
Brazo pared redondo 24 cm
Round wall 24 cm

Box: 1 | Carton: 42 | Pallet: 1260

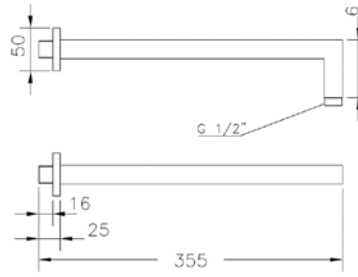

Ref.: B63113 26
Brazo pared cuadrado 35 cm
Square wall arm 35 cm

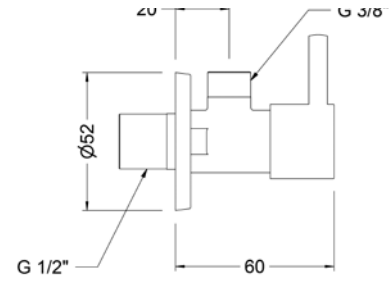

Ref.: 3104 04
Válvula de escuadra redonda 3/8"
Round angle valve 3/8"

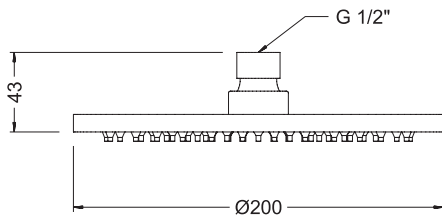

Ref.: R68113 43
Rociador redondo 20cm Bronce
Bronze round shower head 20cm

Box: 1 | Carton: 1

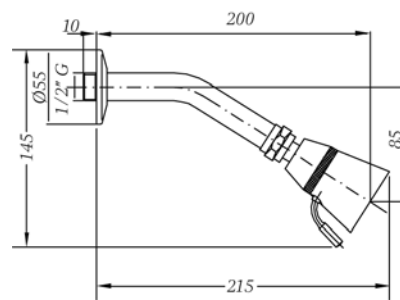

Ref.: 1698 45 00
Rociador ducha con brazo
Wall shower arm and spray

Box: 1 | Carton: 15 | Pallet: 480

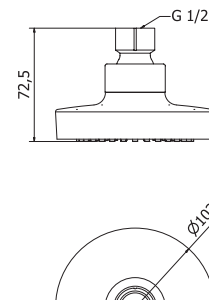

Ref.: 1155 04
Rociador cilíndrico 10cm
Cylindrical shower head 10cm

Box: 1 | Carton: 48 | Pallet: 864

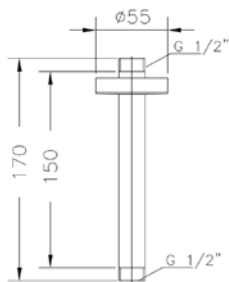

Ref.: 1671 45
Brazo a techo redondo 15 cm
Round roof arm 15 cm

Box: 1 | Carton: 20 | Pallet: 600

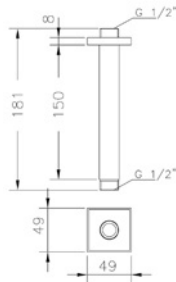

Ref.: 1672 45
Brazo a techo cuadrado 15 cm
Square roof arm 15 cm

Box: 1 | Carton: 20 | Pallet: 800

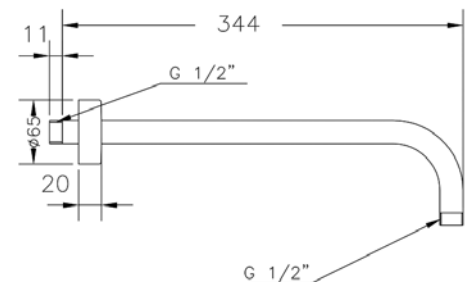

Ref.: B65113 18
Brazo pared redondo 35 cm
Round wall arm 35 cm

Box: 1 | Carton: 20 | Pallet: 600

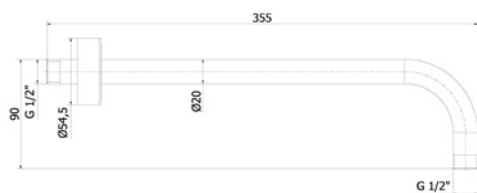

Ref.: B64113 41
Brazo pared redondo 35 cm negro
Black round wall arm 35 cm

Box: 1 | Carton: 20 | Pallet: 600

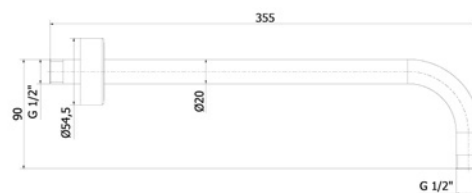

Ref.: B64113 43
Brazo pared redondo 35cm Bronce
Bronze round wall arm 35cm

Box: 1 | Carton: 1

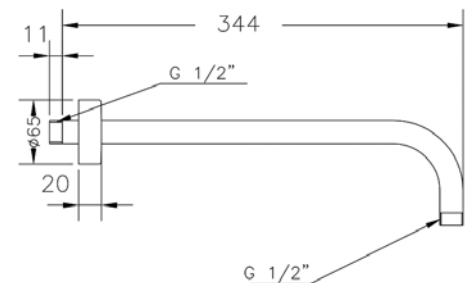

Ref.: B65114 18
Brazo pared redondo 24 cm
Round wall 24 cm

Box: 1 | Carton: 42 | Pallet: 1260

serie Accesorios |

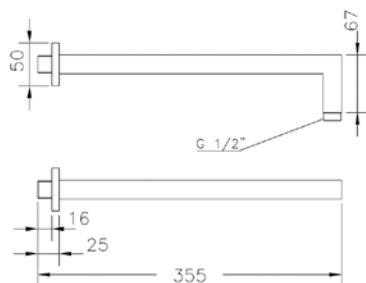

Ref.: B63113 26
Brazo pared cuadrado 35 cm
 Square wall arm 35 cm

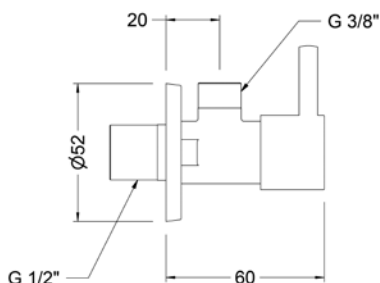

Ref.: 3104 04
Válvula de escuadra redonda 3/8"
 Round angle valve 3/8"

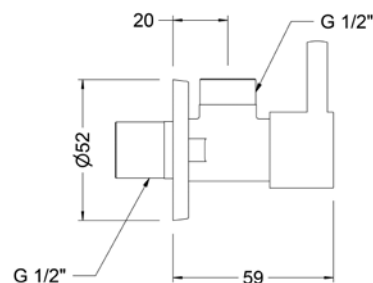

Ref.: 3110 04 41
Válvula de escuadra redonda 1/2" Negro
 Black Round angle valve 1/2"

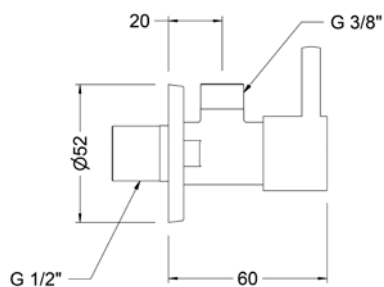

Ref.: 3110 03 41
Válvula de escuadra redonda 3/8" Negro
 Black Round angle valve 3/8"

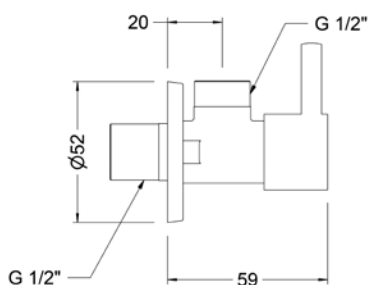

Ref.: 3104 05
Válvula de escuadra redonda 1/2"
 Round angle valve 1/2"

Box: 2 | Carton: 120

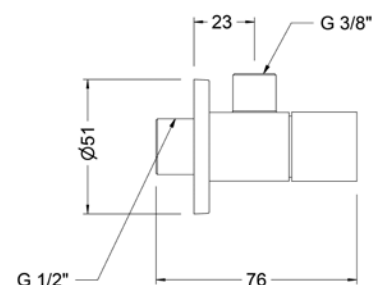

Ref.: 3106 04
Válvula de escuadra cuadrada 3/8"
 Square angle valve 3/8"

Box: 2 | Carton: 120 | Pallet: 4320

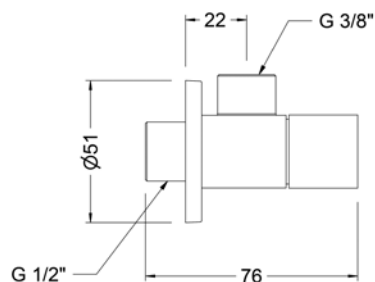

Ref.: 3106 05
Válvula de escuadra cuadrada 1/2"
 Square angle valve 1/2"

Box: 2 | Carton: 120 | Pallet: 4320

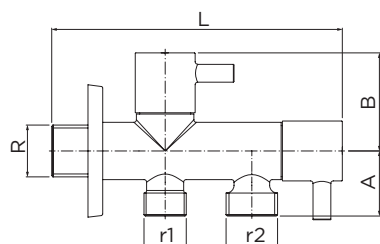

Ref.: 3109 04
Válvula de escuadra doble 1/2" - 3/8"
 Double angle valve 1/2" - 3/8"

Box: 1 | Carton: 90 | Pallet: 2160

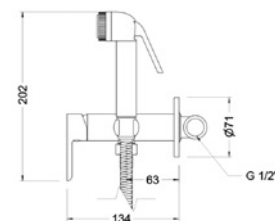

Ref.: 65144 19 45 66
Set mezclador sanitario de ducha con soporte
 Sanitary shower mixer set with support

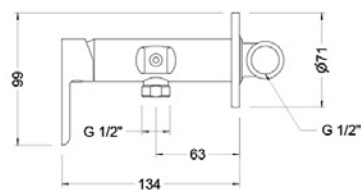

Ref.: 65144 19 45 67
Mezclador sanitario de ducha con soporte
 Sanitary shower mixer with support

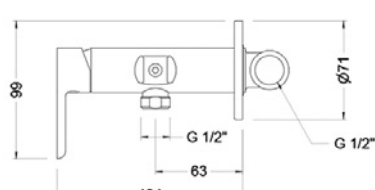

Ref.: 65144 19 41 67
Mezclador sanitario de ducha con soporte Negro
 Black Sanitary shower mixer with support



Ref.: 100694 45
Kit ducha sanitaria
 Sanitary shower kit

Box: 1 | Carton: 22 | Pallet: 264

serie Accesorios |

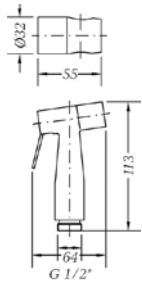

Ref.: 100694 60
Kit ducha sanitaria inox
 Stainless steel sanitary shower kit
Box: 1 | Carton: 22 | Pallet: 264

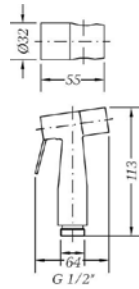

Ref.: 100694 41
Kit ducha sanitaria Negro
 Black Sanitary shower kit

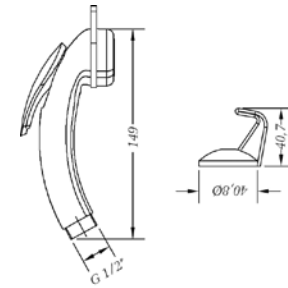

Ref.: 100696 45
Kit ducha sanitaria
 Sanitary shower kit
Box: 1 | Carton: 100 | Pallet: 1800

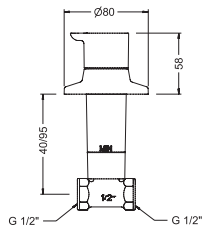

Ref.: 60170 41 45 66
Llave de paso 1/2"
 1/2" Stopcock

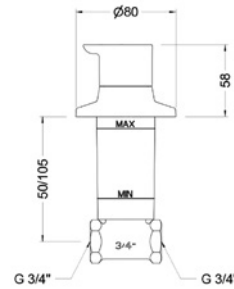

Ref.: 60171 41 45 66
Llave de paso 3/4"
 3/4" Stopcock

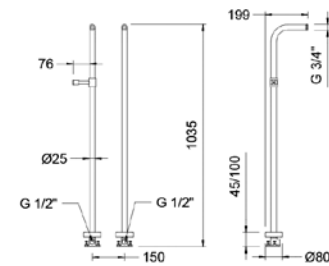

Ref.: 65120 45
Pies para mezclador de bañera
 Floor support for bath mixer

Box: 1 | Carton: 2

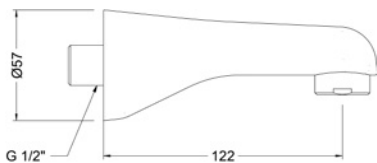

Ref.: 1667 45
Caño mural baño fundido
 Casted wall bath spout
Box: 1 | Carton: 60 | Pallet: 1080

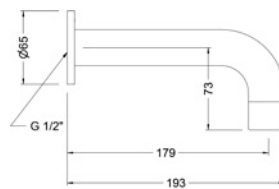

Ref.: 1668 45
Caño mural baño cilíndrico
 Round wall bath spout
Box: 1 | Carton: 20 | Pallet: 240

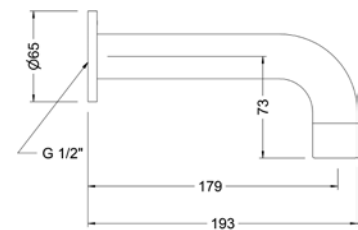

Ref.: 1668 41
Caño mural baño cilíndrico Negro
 Black Round wall bath spout

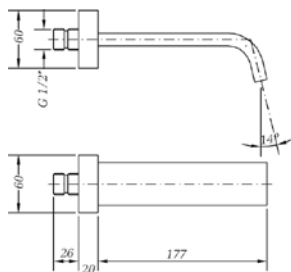

Ref.: 1674 45
Caño mural baño cuadrado
 Square wall bath spout
Box: 1 | Carton: 24 | Pallet: 720

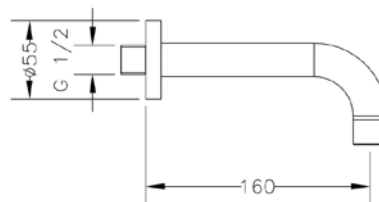

Ref.: 68911 45
Caño mural tubo recto 16 cm
 Wall-mounted pipe spout 16 cm
Box: 1 | Carton: 40 | Pallet: 640

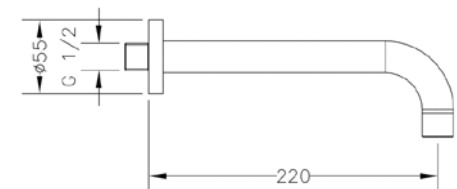

Ref.: 68912 45
Caño mural tubo recto 22 cm
 Wall-mounted pipe spout 22 cm
Box: 1 | Carton: 40 | Pallet: 640

serie Accesorios |

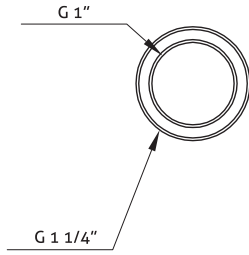

Ref.: 9908 0046
Adaptador sifón 1 1/4" a 1"
 1 1/4" to 1" Siphon adaptor

Box: 100 | Carton: 400

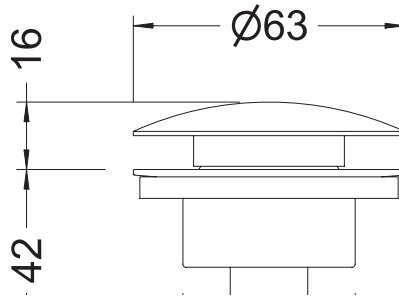

Ref.: 100202 45
Tapa universal "Click remove"
 "Click remove" universal cover

Box: 1 | Carton: 60 | Pallet: 1080

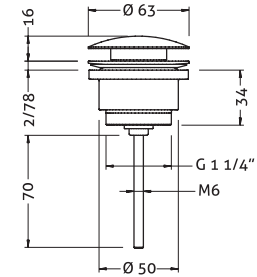

Ref.: 100211 45
Válvula universal click Luxe con y sin rebosadero
 Luxe universal click pop-up waste with and without overflow

Box: 1 | Carton: 60 | Pallet: 1080

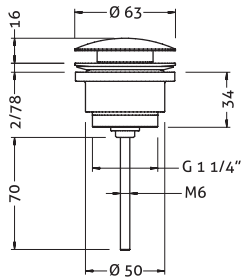

Ref.: 100211 41
Válvula universal click Luxe con y sin rebosadero Negro
 Black luxe universal click pop-up waste with and without overflow

Box: 1 | Carton: 60 | Pallet: 1080

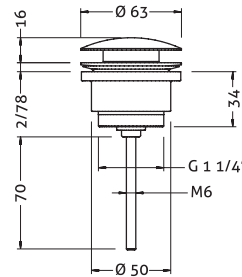

Ref.: 100211 43
Válvula universal click Luxe con y sin rebosadero bronce
 Bronze Luxe universal click pop-up waste with and without overflow

Box: 1 | Carton: 60 | Pallet: 1080

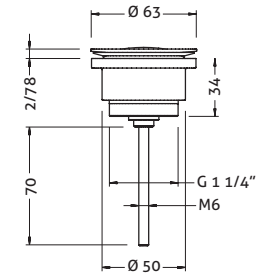

Ref.: 100205 45
Válvula universal click con y sin rebosadero
 Universal click pop-up waste with and without overflow

Box: 1 | Carton: 60 | Pallet: 1080

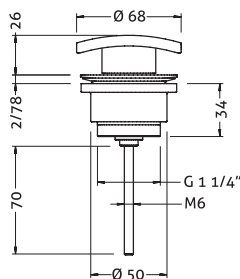

Ref.: 100204 45
Válvula universal click Kenjo con y sin rebosadero
 Kenjo universal click pop-up waste with and without overflow

Box: 1 | Carton: 60 | Pallet: 1080

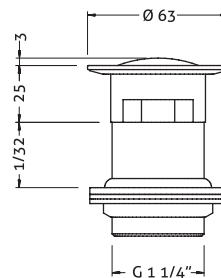

Ref.: 100206 45
Válvula universal click lavabo y bidé click con rebosadero
 Click pop-up waste for basin and bidet with overflow

Box: 1 | Carton: 60 | Pallet: 1080

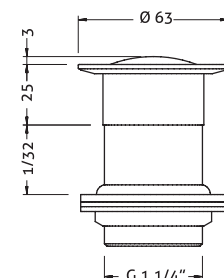

Ref.: 100207 45
Válvula universal lavabo y bidé click
 Click pop-up waste for basin and bidet

Box: 1 | Carton: 60 | Pallet: 1080



serie Accesorios |

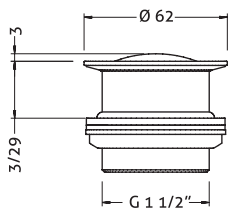

Ref.: 100208 45
Válvula universal click para bañera
 Click pop-up waste for bath

Box: 1 | Carton: 80 | Pallet: 1440



9908 0154 | 9908 0156 | 9908 0166

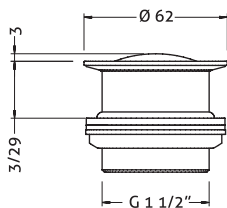

Ref.: 100208 43
Válvula universal click para bañera Bronce
 Bronze Click pop-up waste for bath



9908 0154 | 9908 0156 | 9908 0347

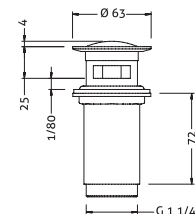

Ref.: 100209 45
Válvula universal click lavabo y bidé click doble función
 double function click pop-up waste for basin and bidet

Box: 1 | Carton: 60 | Pallet: 1080



9908 0152 | 9908 0350 | 9908 0157 | 9908 0168

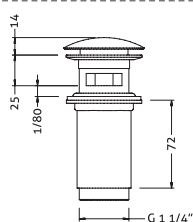

Ref.: 100210 45
Válvula universal click lavabo y bidé click doble función
 Double function click pop-up waste for basin and bidet

Box: 1 | Carton: 60 | Pallet: 1080



9908 0152 | 9908 0350 | 9908 0157 | 9908 0167

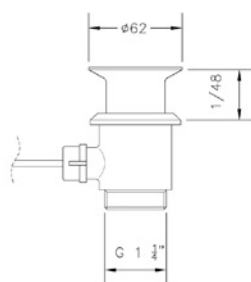

Ref.: 100200 45
Válvula automática plástico 1 1/4"
 1 1/4" plastic automatic valve

Box: 1

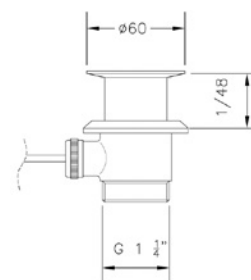

Ref.: 100203 45
Válvula automática metálica 1 1/4"
 1 1/4" metallic automatic valve

Box: 1

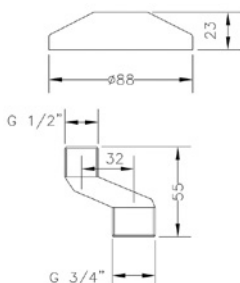

Ref.: 100122 45
Conjunto florón y excéntricas gigantes
 Giant scutcheon and eccentric set

Box: 1 | Carton: 72 | Pallet: 1728

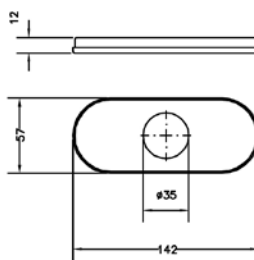

Ref.: P130
Placa adaptadora 4"
 4" adaptor plate

Box: 5 | Carton: 240 | Pallet: 4320

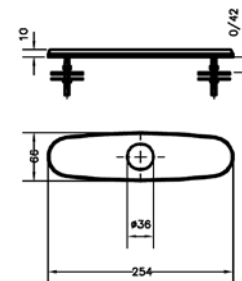

Ref.: P200
Placa adaptadora 8"
 8" adaptor plate

Box: 5 | Carton: 100 | Pallet: 3600

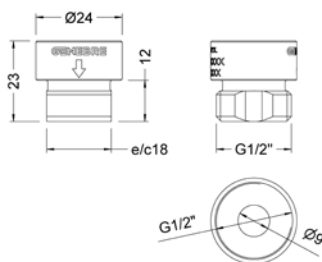

Ref.: 9908 0300 - 9908 0307
Conector 1/2\"/>

Box: 1 | Carton: 50

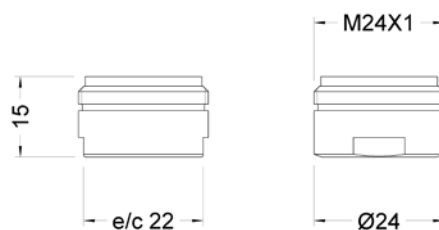

Ref.: 9908 0310 - 9908 0315
Aireador antical M24x1 baja presión
 M24x1 Anti-lime low pressure aerator

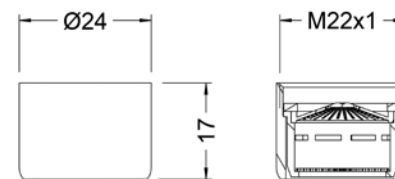

Ref.: 9908 0316 - 9908 0321
Aireador antical H22x1 baja presión
 F22x1 Anti-lime low pressure aerator

Índice por referencia

Index by reference



Localiza la referencia en este índice para encontrar la página donde ver el producto o la página para obtener su información técnica.

Locate the reference in this index to find the page where you can find the product or the page to get its technical information.



Información de producto
Product information









Información técnica
Technical information



Puedes ampliar información en:
You can get more information at:

www.genebre.es





Página Page			Página Page			Página Page		
Ref.:	 Product	 Technical Info	Ref.:	 Product	 Technical Info	Ref.:	 Product	 Technical Info
100068 45	190	265	1632 41	55	270	60001 22 45 67	106	236
100122 45	201	272	1633 04	190	265	60100 22 45 66	103	235
100135 60 00	189	264	1634 04	190	265	60100 28 45 66	98	234
100137 60 00	189	264	1635 04	190	265	60110 22 45 66	103	235
100140 30	189	264	1636 45	191	264	60110 28 45 66	98	234
100141 45	189	264	1637 45	191	264	60130 22 45 66	102	234
100149 45	190	265	1638 45	191	264	60130 28 45 66	96	233
100152 45 00	190	264	1639 45	191	264	60134 28 45 66	96	233
100153 45	190	265	1640 41	55	270	60136 28 45 66	96	233
100175 45 00	188	263	1643 45	192	265	60140 22 45 66	102	235
100197 45 00	188	263	1649 04	190	265	60140 28 45 66	97	233
1002 04	104	235	1667 45	196	269	60170 41 45 66	194	269
100200 45	199	272	1668 41	55, 196	269	60171 41 45 66	194	269
100202 45	198	261	1668 45	196	269	60188 22 45 66	102	234
100203 45	199	272	1671 41	54, 193	266	60188 28 45 66	97	233
100204 45	198	271	1671 45	193	267	60194 05 45 66	167	256
100205 45	198	271	1672 45	193	266	60198 05 45 66	157	256
100206 45	198	271	1674 45	196	269	60199 05 45 66	157	256
100207 45	198	271	1679 04	190	265	61115 22 45 66	103	235
100208 43	199	272	1680 04	190	265	61115 28 45 66	98	234
100208 45	198	272	1698 45 00	192	266	61116 22 45 66	103	235
100209 45	199	272	1699 45 00	192	266	61116 28 45 66	98	234
100210 45	199	272	1744 41	52	247	61130 22 45 66	102	234
100211 41	55, 198	271	1744 45	45	246	61130 28 45 66	96	233
100211 43	113, 198	271	1745 45	61, 78, 146	247	61142 22 45 66	102	235
100211 45	198	271	1746 45	93, 144	248	61142 28 45 66	97	234
1003 04	105, 185	235	1747 45	147, 191	264	61190 28 45 66	167	255
1005 04	184	256	1748 45	61, 140, 142, 191	264	61192 28 45 66	167	255
1006 04	106, 185	236	1946 41	54, 190	265	61195 28 45 66	167	255
100694 41	51, 194	224	3104 04	194	267	61196 28 45 66	167	256
100694 45	194	268	3104 05	194	268	61200 28 45 66	153	256
100694 60	194	269	3106 04	194	268	61201 28 45 66	153	255
100696 45	106, 194	269	3106 05	194	268	61203 28 45 66	153	255
100697 45	189	263	3109 04	194	268	61204 28 45 66	153	255
100698 45	189	263	3109 05	194	268	61205 28 45 66	163	255
100699 45	189	263	3110 03 41	55, 194	268	61206 28 45 66	163	255
1007 04	106, 185	236	3110 04 41	55, 194	268	61210 28 45 66	153	255
1008 04	184	256	568083 45	182	261	61900 28 45 66	168	256
1009 04	184	256	568104 45	182	261	62100 08 45 67	32	220
1023 04	105, 185	235	568193 45	182	261	62110 31 45 67	32	220
1024 04	105, 185	236	568195 45	182	261	62114 30 45 66	33	221
1155 04	192	266	568550 45	178	259	62115 31 45 66	33	220
1621 07	199	270	568555 45	178	259	62117 31 45 66	33	220
1622 07	199	270	568565 45	178	259	62118 31 45 66	33	220
1626 41	55, 199	270	568575 45	178	259	62119 31 45 66	32	220



Página | Page

Ref.:	 Product	 Technical Info
62130 08 45 66	30	219
62131 31 45 66	31	219
62132 31 45 66	31	220
62136 08 45 66	30	219
62140 08 45 66	31	220
62142 31 45 66	31	220
63100 26 45 67	90	232
63110 26 45 67	90	232
63114 30 45 66	133	242
63115 26 45 66	91	232
63116 26 45 66	91	232
63119 26 45 66	91	233
63130 26 45 66	88	231
63131 26 45 66	88	231
63132 26 45 66	89	232
63134 26 45 66	88	231
63136 26 45 66	88	231
63137 26 45 66	88	231
63138 26 45 66	88	231
63140 26 45 66	90	232
63142 26 45 66	90	232
64100 04 45 66	67	226
64100 16 45 66	59	225
64100 32 45 66	24	218
64110 04 45 66	67	227
64110 16 45 66	59	225
64110 32 45 66	24	219
64111 14 45 67	77	229
64114 14 45 67	77	229
64114 30 45 66	26	219
64115 16 45 66	60	225
64115 32 45 66	26	219
64116 16 45 66	60	225
64116 32 45 66	26	219
64117 04 45 66	68	227
64117 32 45 66	26	219
64118 04 45 66	68	227
64118 32 45 66	26	219
64119 32 45 66	24	218
64130 04 45 66	66	226
64130 16 45 66	58	224
64130 32 45 66	22	218
64131 16 45 66	58	225
64131 32 45 66	23	218
64132 16 45 66	58	225



Página | Page

Ref.:	 Product	 Technical Info
64132 32 45 66	23	218
64134 04 45 66	66	226
64134 16 45 66	58	224
64134 32 45 66	22	218
64136 04 45 66	66	226
64136 16 45 66	58	224
64136 32 45 66	22	218
64140 04 45 66	66	226
64140 16 45 66	59	225
64140 32 45 66	23	218
64142 16 45 66	59, 66	225
64142 32 45 66	23	218
64192 16 45 66	166	249
64192 32 45 66	166	249
64201 04 45 66	152	250
64201 16 45 66	152	249
64201 32 45 66	152	249
64206 16 45 66	163	249
64206 32 45 66	163	249
65100 18 45 66	74	228
65100 19 41 66	50	224
65100 19 45 66	42	222
65100 29 45 66	83	230
65110 18 45 66	74	228
65110 19 41 66	50	224
65110 19 45 66	42	222
65110 29 45 66	83	230
65114 30 45 66	68, 76	227
65115 18 45 66	76	228
65115 19 41 66	51	224
65115 19 45 66	43	222
65115 29 45 66	84	231
65116 18 45 66	76	229
65116 19 41 66	51	224
65116 19 45 66	43	222
65116 29 45 66	84	231
65117 18 45 66	76	229
65118 18 45 66	76	229
65119 18 45 66	74	228
65119 29 45 66	84	231
65120 45	111, 195	237
65130 19 41 66	48	223
65130 19 45 66	38	221
65131 18 45 66	73	228
65131 19 41 66	48	223



Página | Page

Ref.:	 Product	 Technical Info
65131 19 45 66	39	221
65131 29 45 66	82	230
65132 18 45 66	73	228
65132 19 41 66	48	223
65132 19 45 66	39	221
65132 29 45 66	82	230
65134 18 45 66	72	227
65134 19 41 66	48	223
65134 19 45 66	38	221
65134 29 45 66	82	230
65135 18 45 66	72	227
65135 29 45 66	82	230
65136 18 45 66	72	227
65136 19 41 66	48	221
65136 19 45 66	38	221
65136 29 45 66	82	230
65138 18 45 66	72	228
65139 19 41 66	40	223
65139 19 45 66	40	221
65140 19 41 66	50	223
65140 19 45 66	39	222
65142 18 45 66	73	228
65142 19 41 66	50	223
65142 19 45 66	39	222
65142 29 45 66	83	230
65144 19 41 67	51, 195	268
65144 19 45 66	39, 195	268
65144 19 45 67	195	2268
65145 18 45 66	73	228
65145 29 45 66	83	230
65192 18 45 66	166	252
65192 19 45 66	166	249
65200 19 45 66	154	249
65203 18 45 66	152	250
65203 18 60 66	169	254
65203 19 45 66	154	249
65204 18 45 66	152	250
65205 18 45 66	162	252
65206 18 45 66	162	252
65207 18 60 66	164, 169	254
65211 18 45 66	164	250
65211 18 60 66	164, 169	254
65212 18 45 66	164	250
65214 18 45 66	152	250
65215 18 45 66	156	251



Página | Page

Ref.:	Página Page	
	 Product	 Technical Info
65215 40 60 66	170	254
65219 18 45 66	156	251
65219 40 60 66	170	254
65403 18 40 66	155	251
65403 18 41 66	155	251
65403 18 44 66	155	251
65403 18 45 66	155	251
65404 18 45 66	154	250
65700 18 45 66	159	252
65702 18 45 66	159	252
65703 18 60 66	159	252
65900 18 45 66	168	252
67100 26 45 67	91	232
67102 14 45 67	77	229
67103 14 45 67	60	225
67104 14 45 67	60	226
67110 26 45 67	91	232
67112 14 45 67	77	229
68001 09 45 66	118	239
68001 11 45 66	124	241
68003 11 45 66	175	260
68083 11 45 66	181	260
68093 11 45 66	181	260
68100 11 45 66	123	240
68103 11 45 66	180	260
68104 11 45 66	180	260
68110 11 45 66	123	240
68113 07 45 66	137	242
68113 08 45 66	133	243
68113 12 45 66	129	244
68115 07 45 66	137	241
68115 08 45 66	133	243
68115 11 45 66	124	240
68115 12 45 66	129	244
68116 07 45 66	137	242
68116 08 45 66	133	243
68116 11 45 66	124	240
68116 12 45 66	129	244
68120 07 45 66	136	241
68120 08 45 66	132	242
68120 09 45 66	116	238
68120 11 45 66	122	239
68120 12 45 66	128	244
68122 11 45 66	122	239
68124 07 45 66	136	241

Página | Page



Ref.:	Página Page	
	 Product	 Technical Info
68124 08 45 66	132	242
68124 12 45 66	128	244
68125 07 45 66	136	241
68125 08 45 66	132	242
68125 12 45 66	128	244
68130 11 45 66	122	239
68131 07 45 66	136	241
68131 08 45 66	132	243
68131 09 45 66	118	239
68131 11 45 66	124	240
68131 12 45 66	128	244
68132 07 45 66	136	241
68132 08 45 66	132	243
68132 12 45 66	128	244
68140 11 45 66	123	240
68142 07 45 66	137	242
68142 08 45 66	133	243
68142 09 45 66	117	238
68142 11 45 66	123	240
68142 12 45 66	129	245
68160 11 45 66	123	240
68170 07 45 66	137	242
68170 08 45 66	133	243
68170 11 45 66	124	241
68170 12 45 66	129	245
68180 11 45 66	122	240
68190 11 45 66	181	260
68193 11 45 66	180	260
68194 09 45 66	174	258
68194 11 45 66	175	260
68195 11 45 66	180	261
68196 09 45 66	176	256
68196 11 45 66	180	261
68197 11 45 66	180	258
68199 11 45 66	175	261
68200 11 45 66	175	257
68201 39 43 66	172	257
68201 39 45 66	172	257
68500 09 45 66	116	238
68505 09 45 66	116	238
68506 09 43 66	112	237
68506 09 45 66	110	236
68510 09 45 66	116	238
68511 09 45 66	116	238
68515 09 45 66	117	238



Página | Page

Ref.:	Página Page	
	 Product	 Technical Info
68516 09 43 66	112	237
68516 09 45 66	110	236
68520 09 45 66	117	238
68525 09 45 66	117	238
68526 09 43 66	112	237
68526 09 45 66	110	236
68527 09 45 66	118	239
68530 09 45 66	117	239
68531 09 43 66	112	237
68531 09 45 66	110	237
68535 09 45 66	118	239
68540 09 45 66	174	257
68545 09 45 66	174	258
68550 09 45 66	176	257
68555 09 45 66	176	258
68560 09 45 66	176	258
68565 09 45 66	176	258
68570 09 45 66	176	258
68575 09 45 66	177	258
68580 09 45 66	177	259
68585 09 45 66	174	258
68590 09 43 66	113	237
68590 09 45 66	118	239
68595 09 43 66	172	257
68595 09 45 66	172	257
68901 45	178, 182	261
68902 45	178, 182	261
68903 45	178, 182	262
68904 45	178, 182	262
68908 45	178, 182	262
68909 45	178, 182	262
68910 45	178, 182	252
68911 45	196	269
68912 45	196	266
68913 45	196	270
68914 45	196	270
68915 45	197	270
68916 45	197	270
68917 45	197	270
9908 0284	50, 55, 188	263
9908 0287	55, 189	264
9908 0300	200	272
9908 0301	200	270
9908 0302	200	270
9908 0303	200	270

Página | Page

Página | Page

Ref.:	 Product	 Technical Info
9908 0304	200	270
9908 0305	200	270
9908 0306	200	270
9908 0307	200	270
9908 0310	201	271
9908 0311	200	271
9908 0312	200	271
9908 0313	200	271
9908 0314	200	271
9908 0315	200	271
9908 0316	201	271
9908 0317	200	271
9908 0318	200	271
9908 0319	200	271
9908 0320	200	271
9908 0321	200	271
B63113 26	192	267
B64113 41	54, 192	267
B64113 43	113, 192	267
B65113 18	192	267
B65114 18	192	267
CM63110 26	93	248
CM64110 32	27	246
CM65110 18	78	247
CM65110 19	45	246
CM65110 29	85	248
CM65111 19 41	52	247
CT67110 18	78, 85	247, 248
CT67110 19	45	246
CT67110 26	93	248
CT67111 19 41	52	247
DXE2 45	188	263
DXE5 45	188	263
DXK1 45	188	263
DXK3 45	188	262
DXO3 45	188	263
DXT3 45	188	263
DXT5 45	188	263
FRK63400	157	254
FRK63401	157	254
FRT65401	157	251
FRT65402	154	251
FRV61205	162	252
FRV61206	161	252
FRV61207 40	161	253

Ref.:	 Product	 Technical Info
FRV61207 41	161	253
FRV61207 44	161	253
FRV61208 41	160	253
FRV61208 44	160	253
FRV61208 45	160	253
FT00	201	262
FT01	201	262
P130	201	272
P200	201	272
R63112 08	193	265
R63112 26	192, 193	266
R65112 18	192, 193	266
R65112 41	54, 192, 193	266
R68113 43	113, 192	266
ST116 19	44	222

Condiciones Generales de Venta

General Sales Conditions

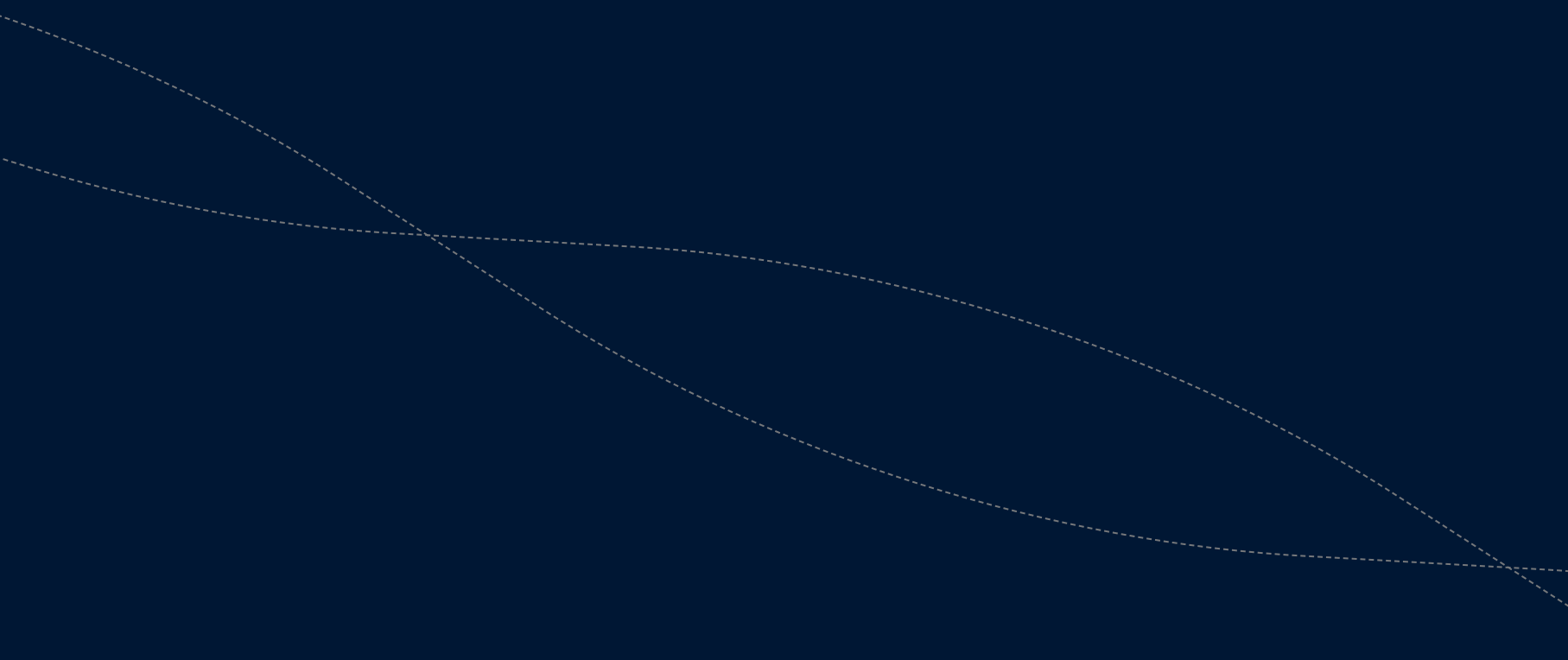

PRECIOS: Los precios se entienden en nuestro almacén, siendo los portes, el I.V.A. y acarreo a cargo del comprador, salvo acuerdo previo en contra.

CONDICIONES DE PAGO: En aplicación de la Ley 15/2010 que limita los plazos máximos de pago en las operaciones comerciales, hemos ajustado las condiciones a lo dispuesto en la misma. En caso de diferirse el pago, los gastos de negociación de efectos y/o los intereses legales especificados serán a cargo del comprador. El impago de cualquier efecto o recibo, conllevará la inmediata suspensión de suministros y servicios.

PEDIDOS: Para la tramitación de cualquier suministro será indispensable que el comprador nos remita el pedido por escrito indicando claramente la referencia Genebre, incluidos los dígitos de la medida y también la cantidad deseada en base a las unidades de compra mínima (por caja), tal como especifica Genebre en su catálogo. Si existen condicionantes no previstos, Genebre S.A. se reserva el derecho de aceptación o anulación de los pedidos cursados. Cada pedido solicitado a Genebre S.A. genera una expedición para el cliente con su coste de transporte correspondiente; por lo que recomendamos preparen sus pedidos completos una vez al día para optimizar el transporte. Todos los pedidos serán confirmados por Genebre, S.A. vía email/fax. Salvo notificación de lo contrario en las siguientes 24 horas, el pedido confirmado seguirá su curso sin derecho a posteriores reclamaciones.

TARIFAS DE PRECIOS: Genebre S.A. comunicará a sus clientes cualquier cambio que se produzca en las tarifas del catálogo a través de alguna de las vías de comunicación usuales (web, email, correo).

CANCELACIÓN DE PRODUCTOS DE CATÁLOGO:

Genebre, S.A. comunicará a sus clientes cualquier cancelación de productos del catálogo.

ESPECIFICACIONES TÉCNICAS: El catálogo de Genebre, S.A. contiene los requisitos técnicos y normas aplicables a los productos suministrados. Genebre S.A. se reserva la facultad de cambiar en todo o en parte el diseño y materiales de cualquiera de sus productos, debido a la mejora continua de nuestros productos.

EXPEDICIONES: Todo pedido superior a 500 euros en Península se suministran a portes pagados. Para Canarias, Ceuta, Melilla y Andorra, el pedido mínimo será de 1.000 euros. Las mercancías viajan siempre por cuenta y riesgo del comprador, aún en los casos de convenios especiales.

ENTREGA: Los pedidos se suministrarán siempre por cajas completas, según especificaciones de catálogo.

RECLAMACIONES: Las eventuales reclamaciones deberán formularse dentro de los 15 días siguientes al de recepción de la mercancía por el comprador, rechazándose las efectuadas después de dicho plazo límite. NO se aceptará ninguna devolución de material sin aprobación previa de nuestro Departamento Comercial que facilitará un número de boletín de devolución que debe acompañar al material devuelto. Todas las devoluciones serán con los portes a cargo del comprador. Y se realizará un cargo por demérito del 10% del valor de la mercancía para todos los materiales, excepto para las válvulas automatizadas que será del 30%.

GARANTÍA: Queda limitada al reemplazo de las piezas reconocidas como defectuosas de fabricación por el Departamento de Calidad de Genebre S.A.. No admitiremos ninguna reclamación transcurridos 15 días de la recepción de la mercancía por el comprador.

PROPIEDAD DE LA MERCANCÍA: Genebre, S.A. se reserva el derecho de propiedad de la mercancía suministrada, hasta que el comprador no haya satisfecho totalmente el importe de la misma. En el intervalo, se considerará en concepto de depósito y custodia. La mercancía podrá ser retirada por incumplimiento de pago en el plazo previamente estipulado.

LITIGIOS: En caso de litigio, ambas partes aceptan someter sus diferencias a los Juzgados de L'Hospitalet de Llobregat.

PRICES: Prices are considered to be EX WORKS, being the freight and transportation at the cost of the purchaser, unless previous agreement has been reached.

PAYMENT TERMS: We have adjusted the conditions in application of Law 15/2010 which limits the maximum terms of payment in commercial transactions. The maximum delay on payment will be of 60 days after invoice date. Payment term will be as accorded between the parties. In case of unpaid, the expenses and interest occurred will be paid by the purchaser. The unpaid maturity will imply the compete suspension of any service or supply.

ORDERS: Regarding the handling of any supply, it is compulsory for the purchaser to send a written signed and sealed purchasing order indicating clearly Genebre's reference, including measures digits, and also the quantity required according to obligated minimum units of purchase (boxes), as Genebre's Catalogue specifies. In case of unexpected discrepancies, Genebre has the right to accept or cancel the pending orders. Each order required to Genebre, S.A., opens a client expedition with corresponding transports cost, because of that, we recommend to prepare complete orders once a day to improve the transport. All the orders will be confirmed by Genebre by e-mail/fax. Each confirmed order will handled without any right from the purchaser to modify it, unless previous notification before 24 hours after confirmation.

PRICE LIST: Genebre will inform the customers about any change in the price list, using some usual communication way (web, e-mail or post).

PRODUCTS WITHDRAWAL FROM CATALOGUE:

Genebre S.A. will inform the customers about any product withdrawal from the catalogue.

TECHNICAL SPECIFICATIONS: Genebres's catalogue holds all the technical requirements and applicable norms about the products.

SHIPMENT: Goods are shipped under the purchaser's own risk, even in special cases.

DELIVERY: Orders will always be shipped according to full boxes, as specified in the catalogue.

CLAIMS: Eventual claims must be done within 15 days after date of reception of the goods by the purchaser. Claims after such period will not be considered. NO devolution will be accepted without the previous approval from our Sales Department, who will issue a devolution certificate that must be enclosed in the devolution goods. All devolutions' freight will be paid by the purchaser. Additionally, an unworthiness debit of 10% of the products' value will be charged, except for the automatic valves that are a 30%.

GUARANTEE: It is limited to defective pieces replacement identified by Genebre's Quality Department. We will not accept any return after 15 days from the date of reception by the purchaser.

PROPERTY OF THE GOODS: Genebre has the property right of the supplied goods, until the purchaser has totally paid its value. In the meantime, it will be considered as deposit and custody. Goods shall be claimed in case of breach of payment terms.

DISPUTES: In case of disputes, both parties agree to solve discrepancies in the Barcelona Court of Justice.

GENEBRE

Feel the Water

GENEBRE

Feel the Water

GENEBRE  **40 YEARS
TOGETHER**

GENEBRE GROUP Edificio Genebre • Avda. Joan Carles I, 46-48
08908 L'Hospitalet de Llobregat (Barcelona) ESPAÑA

www.genebre.es